

Thermal Analysis Excellence

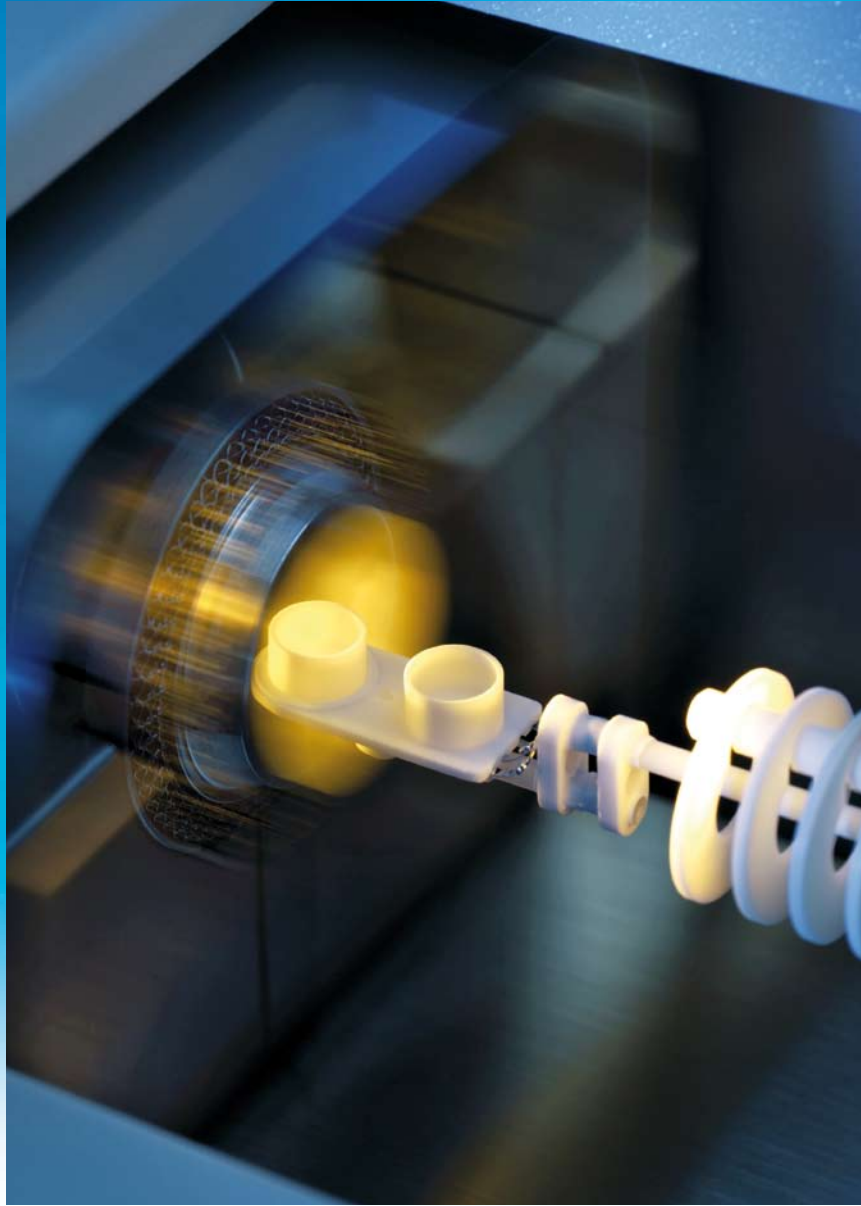

TGA/DSC 1

STAR[®] System

Innovative Technology

Versatile Modularity

Swiss Quality



Thermogravimetry
for Unmatched Performance

METTLER TOLEDO

Unrivalled TGA Performance

with Balances from the Market Leader

Thermogravimetry (TGA) is a technique that measures the change in weight of a sample as it is heated, cooled or held at constant temperature. Its main use is to characterize materials with regard to their composition. Application areas include plastics, elastomers and thermosets, mineral compounds and ceramics as well as a wide range of analyses in the chemical and pharmaceutical industries.

Features and benefits of the TGA/DSC 1:

- **High resolution** – ultra-microgram resolution over the whole measurement range
- **Efficient automation** – reliable sample robot for high sample throughput
- **Wide measurement range** – measure small and large sample masses and volumes
- **Broad temperature scale** – analyze samples from ambient to 1600 °C
- **METTLER TOLEDO ultra-micro balance** – rely on the balance technology leader
- **DSC heat flow measurement** – for simultaneous detection of thermal events
- **Gastight cell** – ensures a properly defined measurement environment
- **Hyphenated techniques** – evolved gas analysis using MS and FTIR
- **Modular concept** – tailor-made solutions for current and future needs

Thanks to its modular design, the TGA/DSC 1 is the ideal instrument for manual or automated operation in production, quality assurance or research and development.

TGA with the top-of-the-line METTLER TOLEDO ultra-micro balance with unique built-in calibration weights ensures unbeatable accuracy.



Unique Sensors the Heart of the Instrument

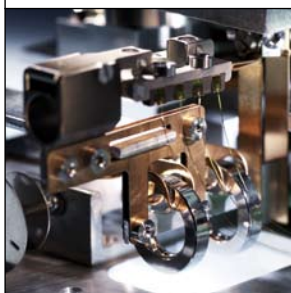

METTLER TOLEDO "Inside"

The heart of a TGA is the balance cell. Our TGA instruments use the world's best METTLER TOLEDO micro and ultra-micro balances. The internal calibration ring weights ensure unsurpassed accuracy. You can also calibrate and adjust your balance with external weights.



MultiSTAR® TGA/DSC sensors

If you want to simultaneously measure heat flow (DSC) in addition to weight change, you can choose between three different sensors:

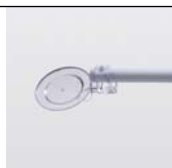

the **SDTA sensor** consists of a platinum support with a thermocouple that measures the sample temperature.



the **DTA sensor** measures the sample and the reference temperatures. The support is made of platinum. The differential measurement improves the signal-to-noise performance of the sensor.



the **DSC sensor** consists of six thermocouples located directly below a protective ceramic support which measure the sample and reference temperatures.

MultiSTAR® sensor amplification technology

The DSC sensor is based on the unique MultiSTAR® sensor amplification technology. The six thermocouples generate a larger measurement signal, which improves the signal-to-noise ratio.

With all three types of sensors, the heat flow is determined from the calculated or measured temperature difference. As with a dedicated DSC, the heat flow is calibrated and adjusted at different temperatures using certified reference materials.

Easy sensor cleaning

It is very easy to remove, change and clean the sensor.

High temperature accuracy

The sample temperature sensor is directly attached to the crucible holder and detects temperature deviations of ± 0.25 K. Temperature calibration and adjustment is performed using the precise melting points of certified reference standards instead of unclearly defined Curie temperatures.

High Performance

Already Built into the Basic Configuration

Horizontal furnace

The horizontal furnace design helps minimize possible turbulence caused by thermal buoyancy and the purge gas.

Precisely defined furnace atmosphere

The gastight cell can be evacuated and purged with a defined gas atmosphere. A controlled closed system with precisely defined conditions like this is essential to obtain unambiguous information and quality results.

Ergonomic design

If you insert samples manually, you can rest your hand on an ergonomically shaped support surface.

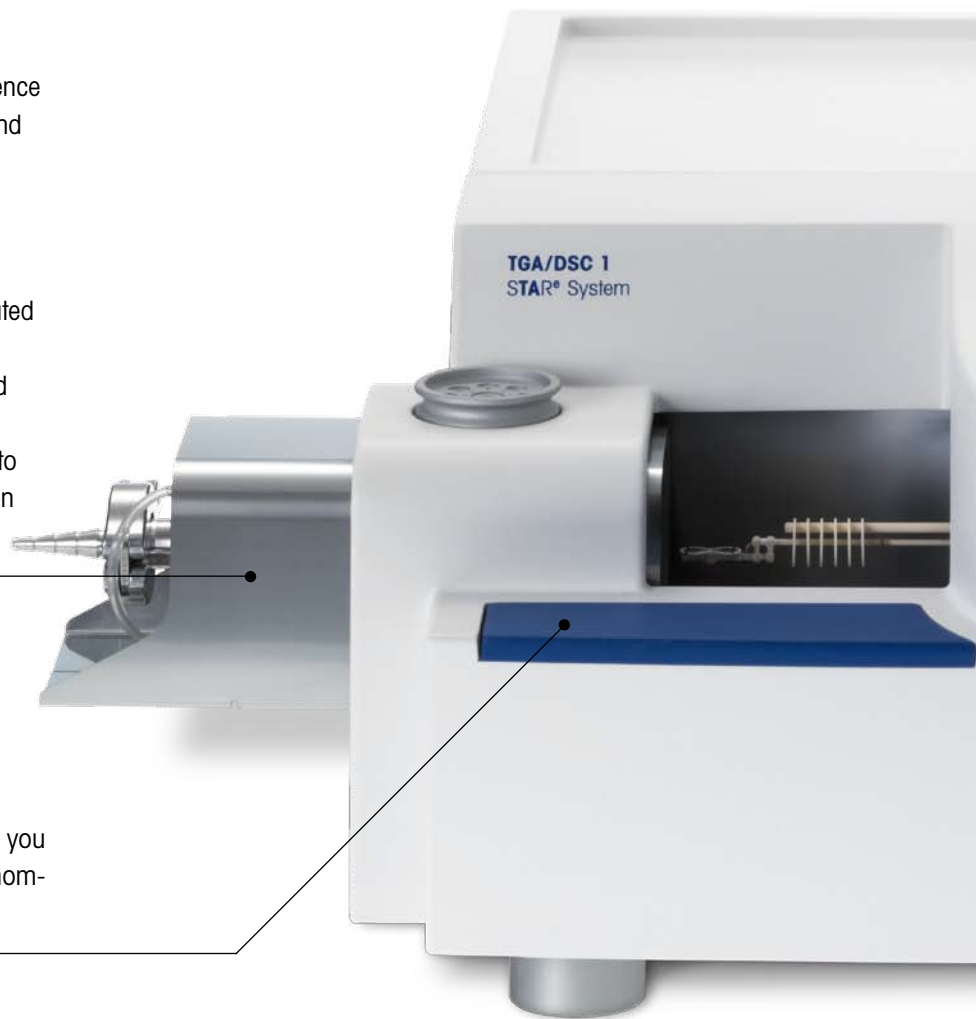

SmartSens terminal

The color touchscreen display allows visual contact with the instrument, even at a distance. Screen displays can be switched touch-free by activating the SmartSens infrared sensors. Identify your instrument by placing a label under the glass cover in the front of the display.





TGA



DSC



TMA



DMA



Complete thermal analysis system

A complete thermal analysis system comprises four different techniques. Each technique characterizes the sample in a particular way.

The combination of all the results simplifies interpretation. TGA measures the weight curve, DSC the heat flow, TMA the length change, and DMA the modulus.

All these measurement quantities change as a function of temperature or time.



Important support services

METTLER TOLEDO prides itself in supplying outstanding instruments and the support needed for you to be successful in your field of work. Our well-trained service and sales engineers are ready and available to help you in any way possible:

- Service and maintenance
- Calibration and adjustment
- Training and application advice
- Equipment qualification

METTLER TOLEDO also provides comprehensive literature on thermal analysis applications.

Excellent Performance Over the Whole Temperature Range

Parallel-guided balance

The parallel-guided balance ensures that the position of the sample does not influence the weight measurement. If the position of the sample changes during melting, no change in weight occurs.

Outstanding weighing performance

No other TGA can measure up to 50 million resolution points continuously - weight changes of a 5-gram sample are determined to 0.1 µg. This means you can measure small and large samples with the same high resolution without having to change the weight range.

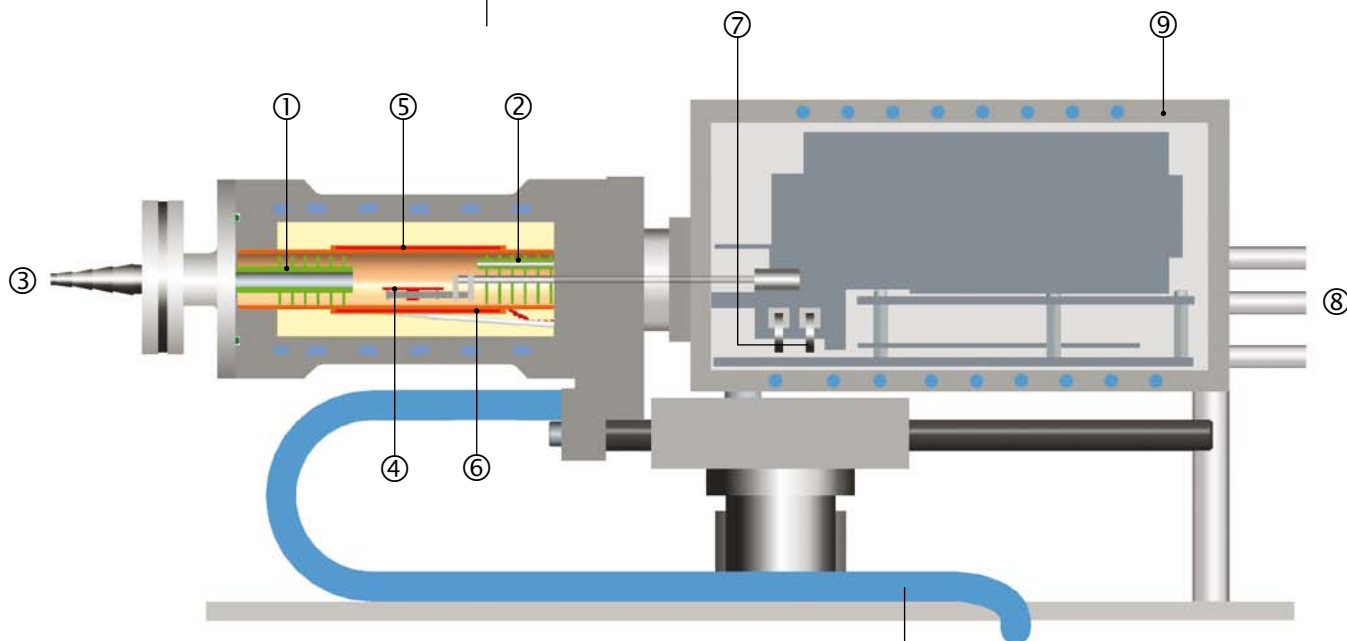
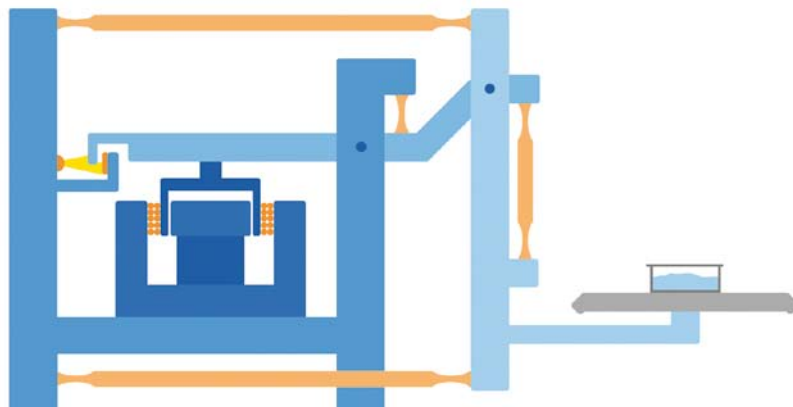

Thermostating

The balance cell is thermostated to minimize environmental influences. The cryostat is also used to rapidly cool the furnace.

Key

- | | |
|--------------------------|--------------------------------------|
| 1 Baffles | 5 Furnace heater |
| 2 Reactive gas capillary | 6 Furnace temperature sensor |
| 3 Gas outlet | 7 Adjustment ring weights |
| 4 Temperature sensors | 8 Protective and purge gas connector |
| | 9 Thermostated balance chamber |

Full Automation

Allows Around-the-Clock Operation

The sample robot is very robust and operates reliably 24 hours a day and throughout the whole year.

Automatic and efficient

All TGA/DSC 1 models can be automated. The sample robot can process up to 34 samples even if every sample requires a different method and a different crucible.

Fully automatic weigh-in

Samples can be weighed-in semi or fully automatically using the internal TGA balance in combination with the sample robot. You only need an additional balance if you want to measure and weigh-in samples at the same time. In the first step, all the empty crucibles are automatically weighed. Afterward, you insert a sample in each crucible, repeat the automatic weighing process and you are ready to start. It's that easy. All the samples are then weighed-in fully automatically.



Features and benefits:

- **Up to 34 sample positions** – dramatically increases efficiency
- **Simple and rugged design** – guarantees reliable results
- **Unique “wasp” lid piercing accessory** – hermetically sealed crucibles are automatically opened prior to measurement
- **Universal gripper** – can handle all types of METTLER TOLEDO crucibles

No weight change before measurement

The sample robot can remove the protective crucible lid from the crucible or pierces the lid of hermetically sealed aluminum crucibles immediately before measurement. This unique feature prevents the sample taking up or losing moisture between weighing-in and measurement. It also protects oxygen-sensitive samples from oxidation.



Modularity a Sound Investment for the Future

Furnaces in different sizes and for different temperature ranges

The measurement of inhomogeneous samples requires large sample amounts and correspondingly large sample volumes. Both the large furnace (LF) and the high-temperature furnace (HT) allow you to use crucibles with volumes of up to 900 μL .

Sensors	SF (1100°C)	LF (1100°)	HT (1600°C)
SDTA	•	•	•
DTA		•	•
DSC			•

Highest temperature accuracy

For the highest temperature accuracy, we recommend the small furnace with its reduced volume (SF). This limits sample volumes to 100 μL .



Program-controlled gas switching and gas flow

Gas flows can be automatically switched, monitored and controlled. This allows you to switch from an inert gas to a reactive gas atmosphere during a measurement.

Designed for the future

You can upgrade from one instrument version to another and add practical accessories any time you like in the future.

Option → required option	MX1	UMX1	MX5	UMX5	EGA (MS, FTIR)	Sorption	Peripheral control	Switched line socket
TGA/DSC 1 (SF 1100 °C)	•	•	•	•	•			
TGA/DSC 1 (LF 1100 °C)	•	•	•	•	•	•		
TGA/DSC 1 (HT 1600 °C)	•	•	•	•	•	•		
GC 10/20 gas controller							essential	
GC 100/200 gas controller								
Cryostat cooling								optional
Hyphenated techniques (MS, FTIR and Sorption)							essential	

• = selectable

Major Accessories

Increase Measurement Power



TGA-MS Interface



TGA-FTIR Interface

Hyphenated techniques

All TGA/DSC 1 versions can be connected online to a mass spectrometer or an FTIR spectrometer. Analysis of the decomposition products yields additional information about the sample. This enables you to interpret measurement curves with greater certainty.



Sorption Interface

Sorption analysis

The TGA can be converted to a TGA Sorption analyzer in just a few minutes. This allows materials to be analyzed under precisely defined conditions of relative humidity and temperature.

Enormous range of crucibles

We have the right crucible for every application. The crucibles are made of different materials with volumes ranging from 20 to 900 μL . All of the different types can be used with the sample robot.

Crucible materials available are:

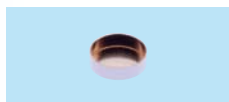

copper

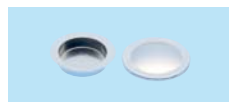

aluminum



alumina



sapphire

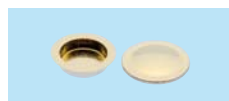

gold



platinum

Extremely Wide Application Range

Thermogravimetry provides quantitative information on the composition and thermal stability of many different types of materials. The method is fast and can even be used with very small samples.

Besides the sample mass, the TGA/DSC simultaneously measures the heat flow of the sample. This enables the instrument to detect thermal events that are not accompanied by a change in mass, such as melting, glass transitions, and solid-solid transitions.

The DSC signal can also be quantitatively evaluated, allowing transition and reaction enthalpies to be determined.

The TGA/DSC is an exceptionally versatile tool for the characterization of physical and chemical material properties under precisely controlled atmospheric conditions. It yields valuable information for research, development and quality

control in numerous fields such as plastics, building materials, minerals, pharmaceuticals and foodstuffs.

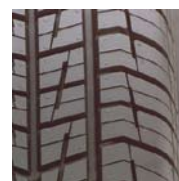

Examples of thermal events and processes that can be determined by TGA/DSC

TGA

- Adsorption and desorption of gases
- Quantitative content analysis (moisture, fillers, polymer content, materials, etc.)
- Kinetics of decomposition processes
- Sublimation, evaporation and vaporization
- Thermal stability
- Oxidation reactions and oxidation stability
- Identification of decomposition products, solvents and solvates
- Sorption and desorption of moisture
- Pseudopolymorphism
- Determination of Curie temperatures

DSC

- Melting behavior
- Crystallization
- Polymorphism
- Phase diagrams
- Glass transitions
- Reaction kinetics
- Heat capacity
- Reaction and transition enthalpies

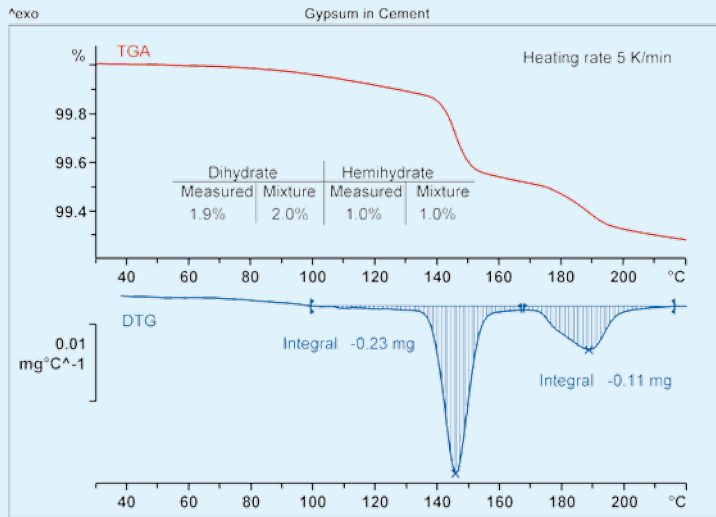

Determination of the gypsum content in cement

Gypsum, $\text{CaSO}_4 \cdot 2\text{H}_2\text{O}$, is used as a retarder in cement and occurs as the dihydrate and hemihydrate. The two compounds can be analyzed in cement by measuring samples in crucibles sealed with lids with 50- μm holes. The TGA curve shows two weight loss steps corresponding to the dehydration of the gypsum and the hemihydrate. The weight losses are more easily determined by integrating the peaks in the first derivative (DTG) curve. The dihydrate and hemihydrate contents determined in this way agree well with the manufacturer's specifications.

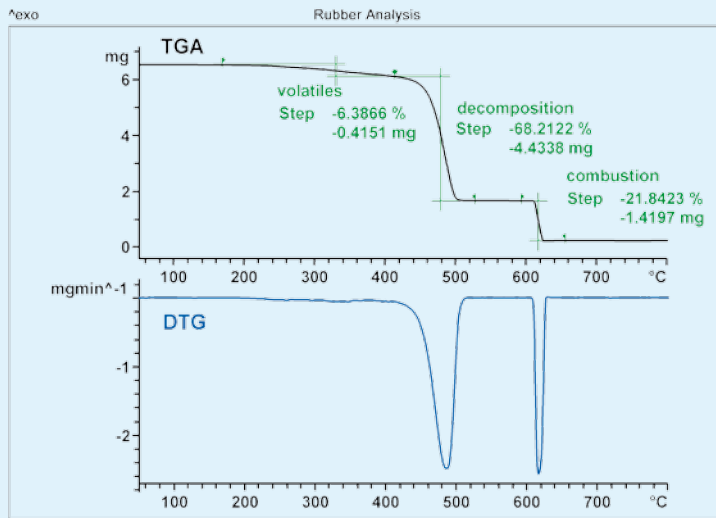

Rubber analysis of SBR

In rubber analysis, the sample is first heated to 600 °C under inert conditions. The volatile components (plasticizers, often oils) vaporize and pyrolysis of the polymer begins shortly afterward at about 400 °C. At 600 °C, the atmosphere is then switched from inert to oxidative, resulting in the combustion of the carbon black additive. Inorganic components remain behind as a residue. The SBR sample analyzed in the example contains 6.4% plasticizer, 68.2% polymer and 21.8% carbon black. The residue (mainly zinc oxide) amounts to 3.6%.

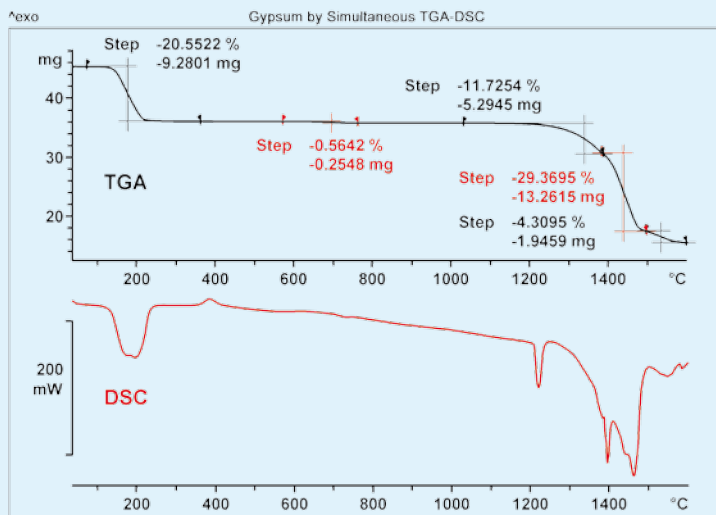

Thermal analysis of gypsum

Gypsum, $\text{CaSO}_4 \cdot 2\text{H}_2\text{O}$, loses its water of crystallization below 300 °C. The calcium carbonate present as an impurity decomposes at about 700 °C. Decomposition of the calcium sulfate occurs in several steps from about 1200 °C onward. The simultaneously recorded DSC curve shows two further effects due to solid-solid transitions at about 390 °C and 1236 °C: $\gamma\text{-CaSO}_4$ (anhydrite III) to $\beta\text{-CaSO}_4$ (anhydrite II), and $\beta\text{-CaSO}_4$ to $\alpha\text{-CaSO}_4$ (anhydrite I). The latter melts slightly below 1400 °C and is observed as a sharp endothermic peak.

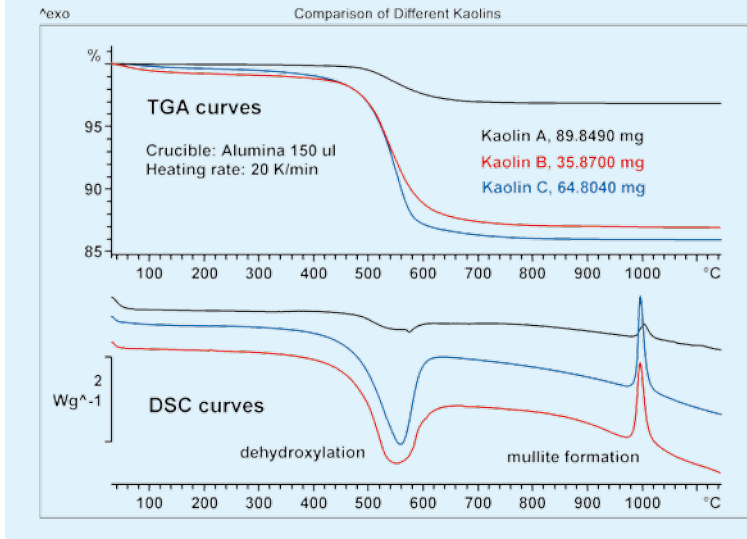

Kaolinite

Kaolin is a white mineral used in the paper industry, as a filler in plastics and for the manufacture of porcelain. The main constituent of kaolin is kaolinite, $\text{Al}_2\text{Si}_2\text{O}_5(\text{OH})_4$, which dehydroxylates between 450 °C and 600 °C. This is the reason for the weight loss in the TGA curves. The example shows the measurement of three kaolin samples with different contents of kaolinite. The DSC curve for Kaolin A shows a small peak at about 575 °C. This peak is characteristic for the solid-solid transition of α -quartz to β -quartz. The exothermic peak at about 1000 °C is due to the formation of mullite.

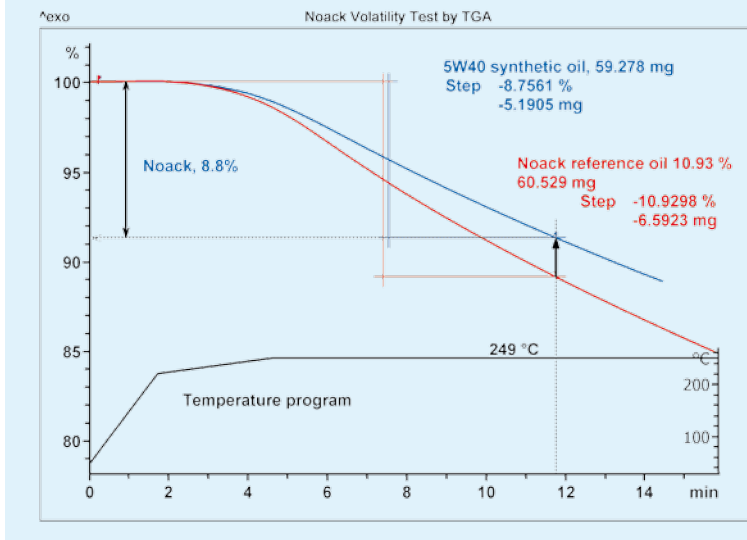

Volatility of oils

The Noack Test according to ASTM D 6375 is used to assess the volatility or evaporation loss of a lubricating oil in comparison with a reference oil at a particular temperature. The procedure is summarized in the figure. The reference oil takes 11.9 min to lose the specified mass loss of 10.93%. The oil under test loses 8.8% of its mass up until this time. Its Noack volatility is therefore 8.8%. The method allows rapid and reliable characterization of oil volatility.

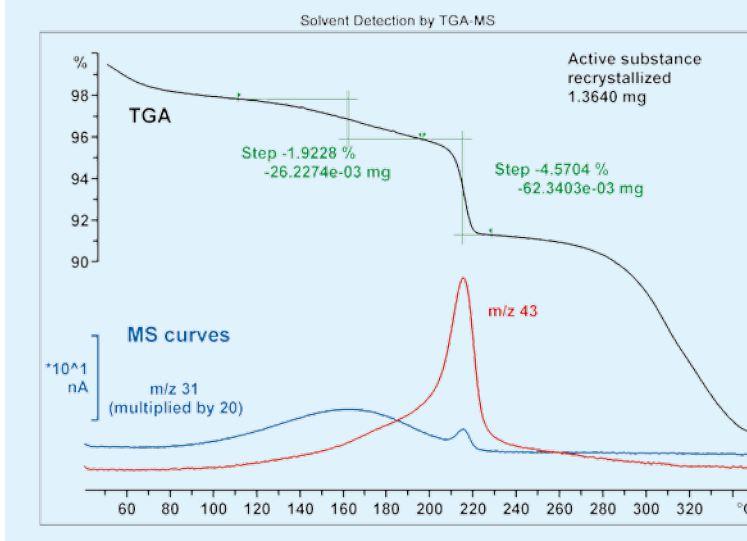

Residual solvents in pharmaceutical substances

Many pharmaceutical substances are recrystallized from solvents. As a result, residues of solvents often remain in the product. Combined techniques such as TGA-MS are ideal to detect and identify such undesired residues. In the example, methanol and acetone were used to recrystallize the active substance. The presence of these two substances is confirmed by the peaks in the m/z 43 and m/z 31 fragment ion curves. The results indicate that the weight loss step at 200 °C is almost entirely due to the elimination of acetone.

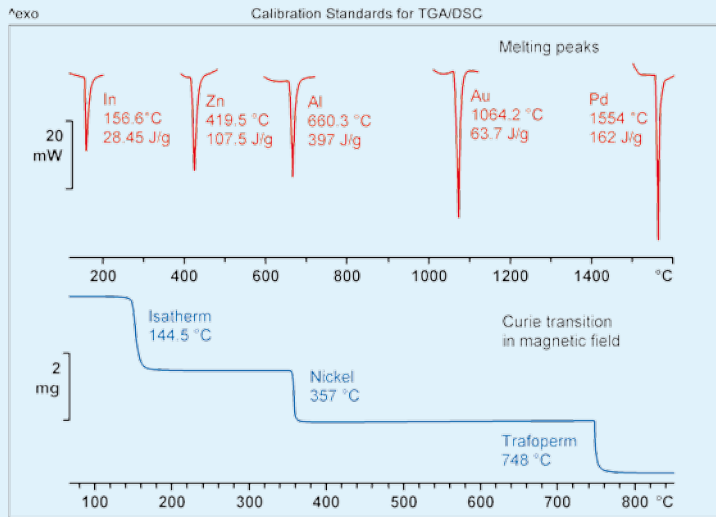

Adjustment of temperature and heat flow

Adjustment of temperature and heat flow is normally performed with certified pure metals. Gold and palladium can be used to calibrate and adjust the temperature and heat flow up to the maximum temperatures specified for the TGA/DSC 1 furnace (1100 °C or 1600 °C). The Curie temperatures of ferromagnetic metals can also be employed for temperature adjustment. This is, however, not recommended because Curie temperatures are not clearly defined, in contrast to melting points of pure metals.

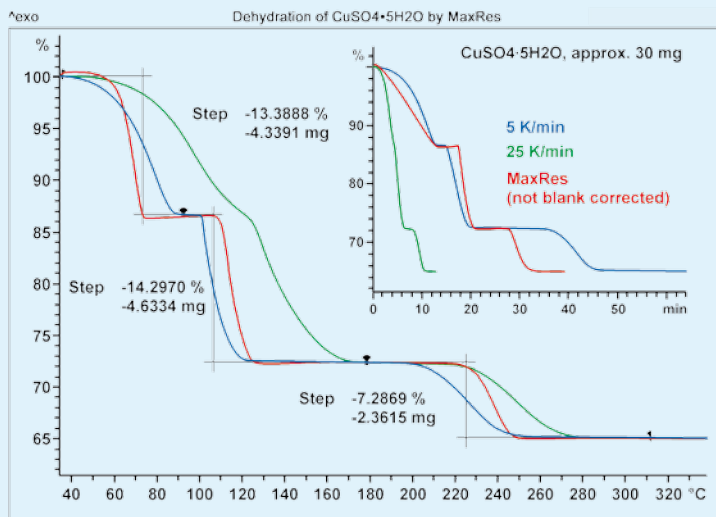

MaxRes: high resolution despite short measurement times

With MaxRes, the heating rate changes automatically depending on the rate of change of weight. This enables overlapping weight loss steps to be optimally separated in the shortest possible time. The example shows the dehydration of copper sulfate pentahydrate. At 25 K/min, the first two weight loss steps are not properly separated. Using MaxRes, the separation is clearly better than at 5 K/min even though the measurement time is much shorter.

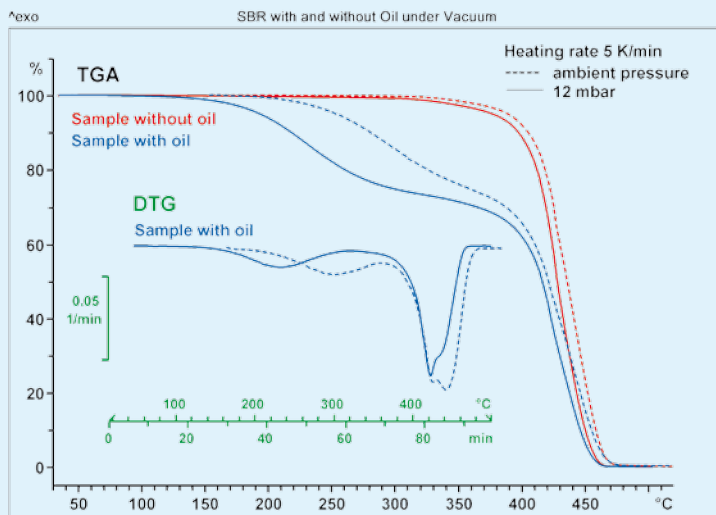
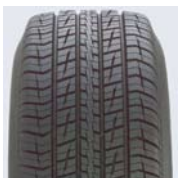

Determination of the plasticizer content in elastomers

Oils are often used as plasticizers in elastomers. Usually, the oil vaporizes in the same temperature range as the elastomer decomposition begins, making it difficult to quantify the oil content. In such cases, the elastomer samples are measured at reduced pressure to separate the two effects. The example shows the weight loss curves of SBR samples with and without oil at normal pressure and at 12 mbar. Pressure hardly influences the measurement curve of SBR without oil. In contrast, when SBR with oil is measured at reduced pressure, the vaporization of the oil and decomposition of the elastomer are almost completely separated.

TGA/DSC 1 Specifications

Temperature data	Small furnace (SF)	Large furnace (LF)	High temp. furnace (HT)
Temperature range	RT ... 1100 °C	RT ... 1100 °C	RT ... 1600 °C
Temperature accuracy ¹⁾	± 0.25 K	± 0.3 K	± 0.5 K
Temperature precision ¹⁾	± 0.15 K	± 0.2 K	± 0.3 K
Furnace temperature resolution	0.001 K	0.001 K	0.002 K
Heating time	5 min (RT ... 1100 °C)	10 min (RT ... 1100 °C)	10 min (RT ... 1600 °C)
Cooling time	20 min (1100 ... 100 °C)	22 min (1100 ... 100 °C)	27 min (1600 ... 100 °C)
Cooling time with helium	≤ 10 min (1100 ... 100 °C)	≤ 11 min (1100 ... 100 °C)	≤ 13 min (1600 ... 100 °C)
Heating rate ²⁾	250 K/min	150 K/min	100 K/min
Cooling rate ²⁾	-20 K/min (≥150 °C)	-20 K/min (≥150 °C)	-20 K/min (≥200 °C)
Sample volume	≤ 100 µL	≤ 900 µL	≤ 900 µL

Special modes		
Automation		
Vacuum		
MaxRes	optional	
TGA-MS		
TGA-FTIR		
TGA sorption	no	optional

Balance data	Measurement range	Resolution
MX1 / MX5	≤ 1g / ≤ 5g	1.0 µg
UMX1 / UMX5	≤ 1g / ≤ 5g	0.1 µg
Internal ring weights	2	
Blank curve reproducibility	better than ± 10 µg over the whole temperature range	

Calorimetric data				
Sensor data (typical values)	Sensor type	SDTA	DTA	DSC
	Surface material	platinum	platinum	ceramic
	Number of thermocouples	1	2	6
	Signal time constant at 900 °C	15 s	14 s	14 s
	sensitivity	0.5 mW	0.2 mW	0.1 mW
	Furnace temperature resolution	0.005 K	0.0001 K	0.00003 K
Enthalpy reproducibility (standard deviation)	better than 5 %			

Sampling	
Sampling rate	maximum 10 values/second

Approvals

IEC/EN61010-1:2001, IEC/EN61010-2-010:2003
 CAN/CSA C22.2 No. 61010-1-04
 UL Std No. 61010A-1
 EN61326-1:2006 (Class B)
 EN61326-1:2006 (industrial environments)
 FCC, Part 15, class A
 AS/NZS CISPR 22, AS/NZS 61000.4.3
 Conformity mark: CE

¹⁾ based on metal standards

²⁾ depends on instrument configuration

www.mt.com

For more information

Mettler-Toledo AG, Analytical

CH-8603 Schwerzenbach, Switzerland
 Phone +41-44-806 77 11
 Fax +41-44-806 73 50
 Internet: www.mt.com

Subject to technical changes
 © 07/2007 Mettler-Toledo AG
 Printed in Switzerland, ME-51724559
 MarCom Analytical



Quality certificate. Development, production and testing according to ISO 9001.



Environmental management system according to ISO 14001.



European conformity. The CE conformity mark provides you with the assurance that our products comply with the most recent EU directives.