



The Agilent 7890A Gas Chromatograph
All the elements for perfect chemistry.

Our measure is your success.

Introducing the Agilent 7890A Gas Chromatograph.

Step up to a higher level of GC reliability, productivity and confidence. Adding an exciting new chapter to a 40-year history of GC leadership, Agilent's new 7890A flagship GC gives you everything you need to take your lab to the next level of GC and GC/MS performance, including advanced separation capabilities, powerful new productivity features and real-time self-monitoring instrument intelligence. Plus, of course, legendary Agilent reliability.



The new Agilent 7890A Gas Chromatograph brings important new separation capabilities and productivity features to the industry-leading Agilent GC platform.

Agilent Performance and Reliability

5th-generation electronic pneumatics control (EPC) and digital electronics set a new benchmark for retention time locking (RTL) precision and help make the 7890A Agilent's most dependable GC ever.

Higher Productivity

Faster oven cool down, robust backflush capability, advanced automation features and faster GC/MS oven ramps let you get more done in less time, at the lowest possible cost per sample—all easily incorporated into your existing method.

Expanded Chromatographic Capabilities

Highly flexible EPC design enables even more sophisticated hydrocarbon analyses. An optional 3rd detector (TCD) can speed up complex gas analyses, and allows more types of analyses to be run on a single GC.

Easier Operation

Powerful, chromatographer-friendly software simplifies method setup and system operation, and minimizes training time. Practical, time-saving design features speed up and simplify routine maintenance.

Easy, direct method transfer from your 6890 GC

Because the Agilent 7890A system is built upon proven 6890 GC inlets, detectors and GC oven, you can transfer methods to the 7890A GC with complete confidence. We make it even easier with Agilent ChemStation software that can automate the process.



Breakthrough Capillary Flow Technology.

*Agilent's innovative Capillary Flow modules enable reliable, leak-free in-oven connections. Available in a number of useful configurations, they are versatile tools for analyzing complex matrices, as well as providing gains in productivity and data integrity. **Page 6***



Perform inlet maintenance in seconds!

Convenient new Turn-Top design is built into each split/splitless (SSL) inlet, allowing you to change liners more quickly and easily than ever before, without special tools or training.

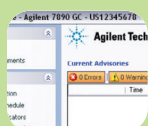

The security of round-the-clock, automated system monitoring and diagnostics.

*New Agilent Lab Monitor & Diagnostic Software tracks usage of supplies, monitors chromatographic quality and alerts you to problems before they happen. **Page 11***



ALS Overlap saves time with every injection.

Using the Agilent 7683 Automatic Liquid Sampler, the 7890A GC can retrieve vials and perform syringe wash steps during the oven cool-down cycle.

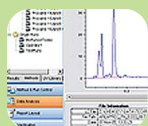

Customized control and data-handling software.

*Choose the software package that exactly meets your lab's needs—from single user/single instrument to multi-instrument/multi-vendor laboratories throughout the world. **Page 10***



Complete selection of options and accessories.

*Configure the exact system to meet your lab's needs today, and easily adapt to changing application and throughput requirements. **Page 12***



One-button access for service, maintenance and logs.

The Agilent 7890A GC's control panel—which will be instantly familiar to 6890 GC users—includes a new button that gives you instant access to routine maintenance information.

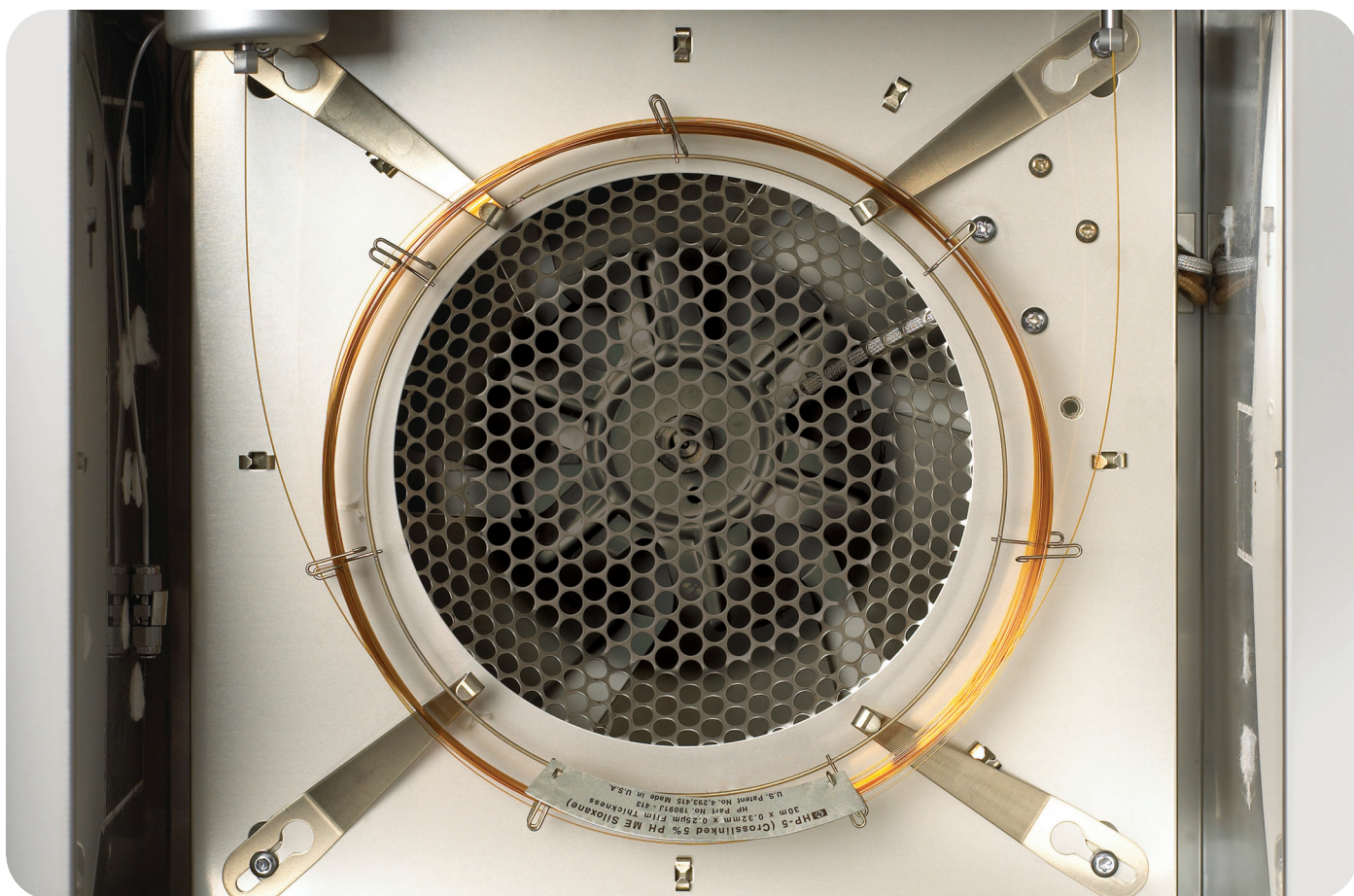

The heart of performance.

The combination of precise pneumatics and GC column oven temperature control leads to outstanding retention time repeatability, the basis for all chromatographic measurement.

At the end of the day, it's about getting a job done.

At Agilent, building the world's most trusted GC solutions is an ongoing process of evolution. Each new generation of instruments offers improved performance, higher productivity, greater precision and new analytical capabilities. It's easy to get excited about technology, and we do. But we never lose sight of the fact that no matter what the application, the bottom line is results: Getting better data with greater confidence, and processing more samples in less time at the lowest possible cost.

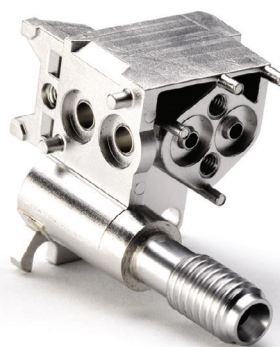

The heart of reliability.

Integrated electronics and advanced mechanical design provide for superior reliability. The pneumatics manifold of the 7890A has been re-engineered for even greater reliability.

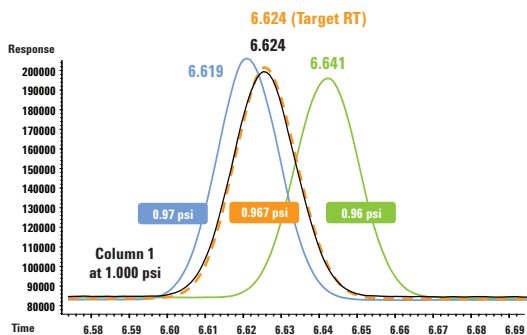

5th-generation EPC and advanced digital electronics set a new benchmark in pressure setpoint precision (to 0.001 psi)—improving RTL precision for very-low-pressure applications.

Retention Time Locking—now even more precise

Agilent’s unique retention time locking (RTL) software enables you to reproduce retention times with extreme precision from one Agilent GC system to another—regardless of inlet, detector, operator or location. This powerful software capability allows you to identify peaks more easily and accurately and increase sample throughput, as well as reducing the risk of noncompliance.

Unsurpassed Retention Time Reproducibility

Run	Peak 1*	Peak 2*
1	9.0839 min	11.8492 min
2	9.0835	11.8492
3	9.0841	11.8494
4	9.0846	11.8496
5	9.0851	11.8507
6	9.0849	11.8502
7	9.0845	11.8504
8	9.0849	11.8500
9	9.0847	11.8504
10	9.0853	11.8502
11	9.0852	11.8502
12	9.0851	11.8508
13	9.0847	11.8503
14	9.0848	11.8507
15	9.0853	11.8506
Average	9.0847 min	11.8501 min
Standard Deviation	0.000527	0.000535

*Heart-cut from column 1.

Full electronic pneumatics control makes it fast and easy to set all pressures and flows. Our 5th-generation EPC and digital electronics keep these setpoints constant from run to run, providing superior retention time repeatability.

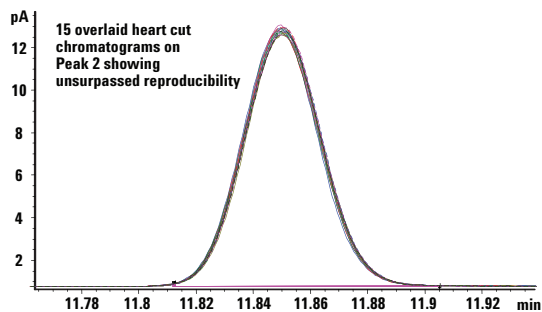

Not only is one ensured unsurpassed retention time reproducibility in standard applications, but also in multi-dimensional applications such as the heart-cutting example shown here.

Add extra dimensions to your chromatography with Agilent Capillary Flow Technology.

Agilent's proprietary Capillary Flow Technology solves a problem chromatographers have been wrestling with for decades: How to make reliable, leak-free capillary connections that can stand up to the temperature extremes of a modern GC oven.

These inert, low-mass, low-dead volume devices not only make it easy to make secure connections; they give you the ability to precisely divert your gas flow pneumatically, where and when you want. This opens the door to highly useful techniques that can improve your analytical results, as well as saving time and resources. For example:

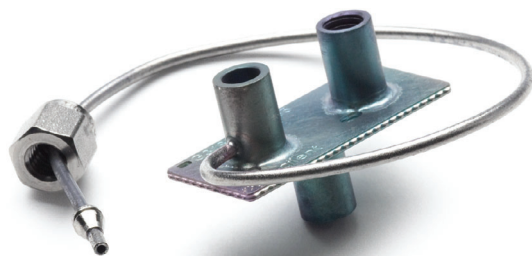

QuickSwap

Here's an elegant answer to a common GC/MS problem: Waiting around for a mass spectrometer to vent before you can change out a column or perform routine inlet maintenance.

Using a simple, inexpensive "QuickSwap" device, you can safely disconnect the column without venting, and without losing vacuum—in about 30 seconds!



Deans Switch

The idea of fluidic switching between two columns, or redirecting effluent, has been around almost since the beginning of GC. But before Capillary Flow Technology, the implementation hasn't been reliable enough for routine use in a GC oven.

Deans switching enables two-dimensional GC ("heart-cutting") for analysis of trace compounds in complex samples. Flow redirection can also reduce maintenance costs by protecting detectors or columns.

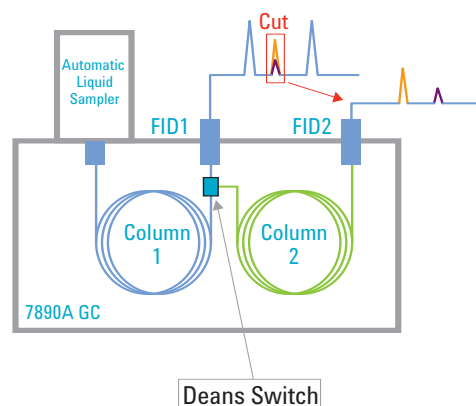

In this example, the Capillary Flow Deans Switch provides additional selectivity that enables the analysis of unresolved trace components by heart-cutting onto another column having a different stationary phase.

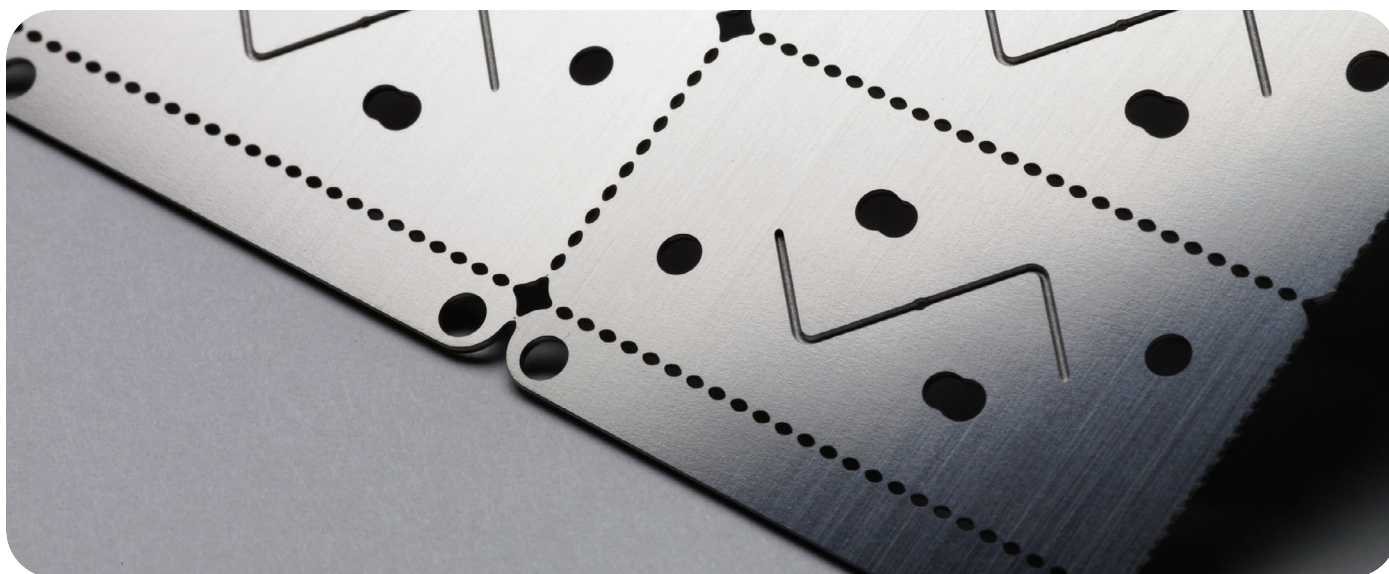

The heart of Capillary Flow Technology.

Photolithographic chemical milling of diffusion-bonded plates provides flow channels with low dead volumes. Low thermal mass ensures reliable tracking of GC oven temperatures.

Flow Splitting

Flow splitting—sending the sample to multiple detectors—can provide the most information from a sample in a single run, and is especially valuable for analyzing compounds in complex matrices. This technique can help you locate peaks of interest faster, get better integration of target peaks and have higher overall confidence in identifying unknowns.

Strawberry Extract Highlighting Unknowns

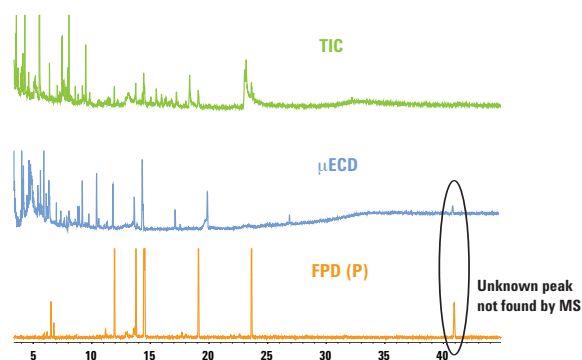

Backflushing

Backflushing is an extremely valuable technique that can be implemented with any purged Agilent Capillary Flow device. It can improve the quality of your analysis and save you time and money on every run—and as backflush occurs post-run, you don't have to change method conditions for the time during the chromatographic run.

By reversing column flow immediately after the last compound of interest has eluted, you can eliminate long bake-out times for highly retained sample components. Instead, these materials are swept backwards through the column and out the split vent, preventing carryover, contamination, retention time shifts, and MSD source contamination.

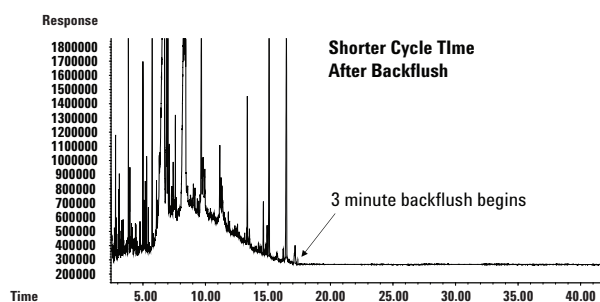
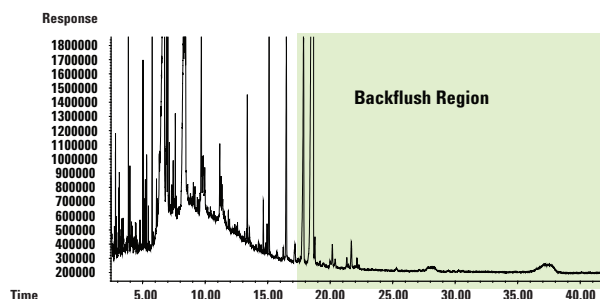

Advanced separation capabilities save time and enhance results.

EPA 8270

5 ppm EPA 8270 standard run spiked into 5000 ppm of a heavy oil to simulate interference from a hazardous waste.

Peaks of interest elute by 16 minutes, but a 24-minute bake-out at 320°C is required to elute heavy components. Using the 7890A system's backflush capability, the sample was rerun with a 4-minute backflush—saving 20 minutes per run (50% total cycle time savings).

ALS Overlap and faster cool down save an additional 4 minutes per cycle.

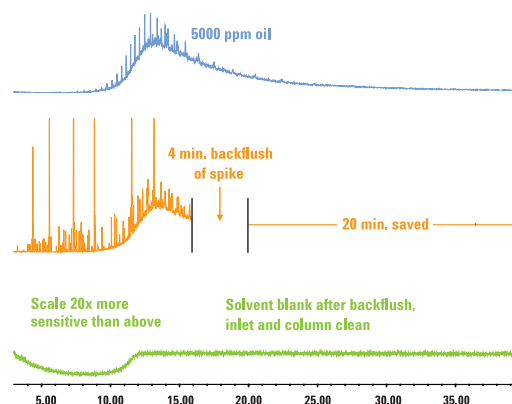

Pesticides in Milk Extract

Flow splitting enables multiple detectors and increased productivity.

The splitter device proportionally splits column effluent to multiple detectors: MSD, DFPD and μ ECD. Full-scan TIC from the MSD provides quantitation and confirmation; element-specific GC signals are useful for highlighting trace-level compounds to be identified by MSD.

The splitter also provides backflush capability to shorten cycle time and increase column life. Backflushing ensures that excess column bleed and heavy residues are not introduced into the MSD, reducing ion source contamination. It also eliminates carryover from sample accumulated at the head of the column, providing a significant improvement in data integrity.

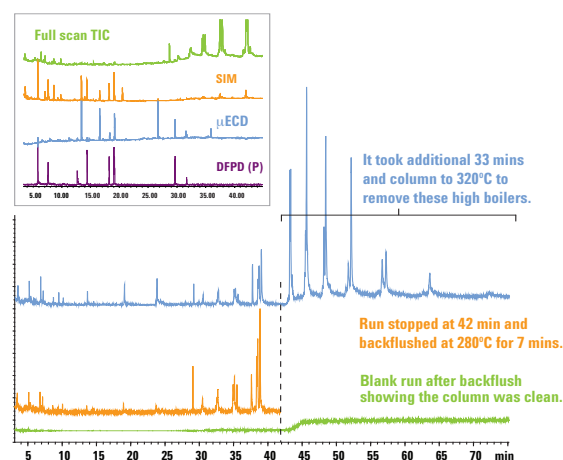

Impurities in Hydrocarbons

Ethylene analysis uses 2D GC to combine measurement by ASTM D6159 with a trace analysis of methanol.

This application takes advantage of Agilent's Capillary Flow Deans Switch device and the new Back Pressure Regulation (BPR) mode of the 7890A GC's Pneumatic Control Module to improve sensitivity and resolution. Dynamic blending systems make multi-level calibrations of gas samples easy and routine.

2-GC Separation of Oxygenates and Hydrocarbon Impurities in Ethylene in a Single Run

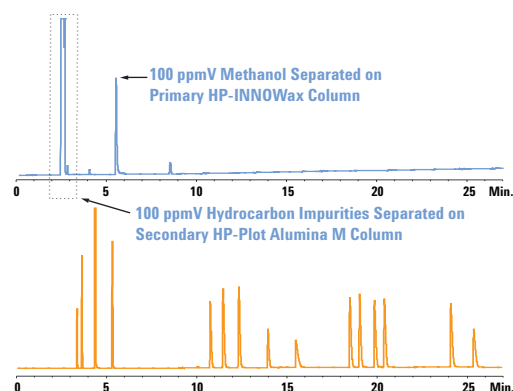

Rapid Drug Screening

Obtaining 3x the information in half the time or less, using GC/NPD/MSD with simultaneous SIM/Scan.

An Agilent Capillary Flow device is used to acquire NPD and MSD data simultaneously. This eliminates the need for a separate NPD screening run on a different GC; backflushing further reduces cycle time. Simultaneous SIM/Scan is used to screen for select low-level drugs, eliminating the need for a separate SIM run.

Overall cycle time is reduced by more than 55%. An existing 6890 GC/MSD method is made twice as fast using a 240V oven. Similar results were also achieved using a 120V oven with the new option for the 7890A high-speed GC/MSD oven. Deconvolution Reporting Software (DRS) further enhances throughput by reducing data interpretation time.

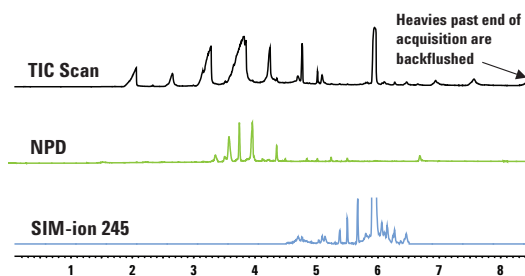

Analysis of Refinery Gases

Faster, high-resolution analysis of complex refinery gas samples using 3 channels of simultaneous detection.

The Agilent 7890A GC now supports an optional 3rd detector (TCD). In this analysis, the GC is configured to run three parallel channels; all three detectors collect data at the same time.

Complete analysis time of inert gases and hydrocarbons to n-C6 can be achieved in 6 minutes.

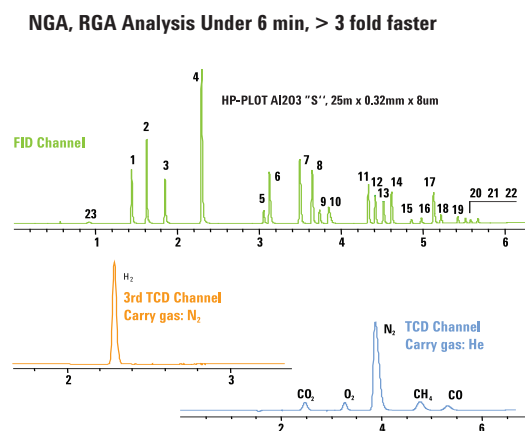

Comprehensive GC Flow Modulation

Capillary Flow Technology enables GC x GC analysis of extremely complex samples—without the need for cryogen.

To date, available GC x GC systems require complicated and costly cryo-focusing techniques. The Agilent 7890A GC uses Capillary Flow Technology to enable flow modulation without the need for cryogen. This analysis of diesel fuel shows the normal boiling point distribution in the first dimension and functional group clusters in the 2nd dimension.

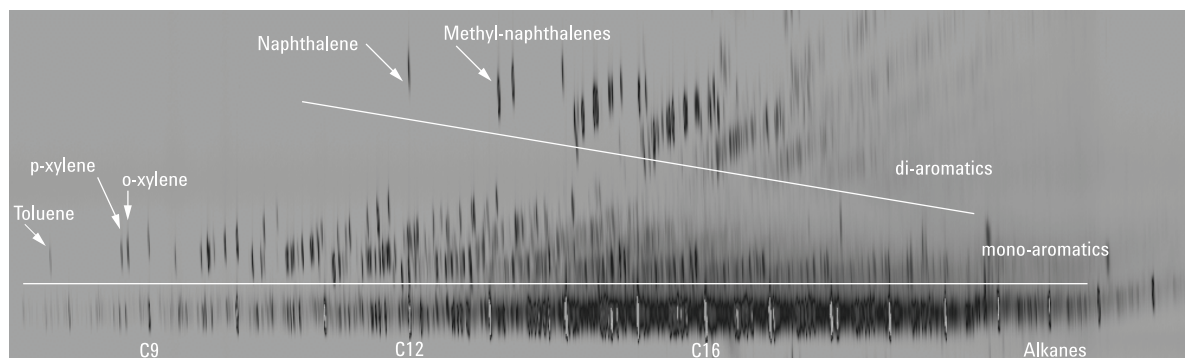

GC software that fits your workflow and your applications—perfectly.

Agilent GC software makes it easy even for non-expert operators to take advantage of all the advanced capabilities of the new Agilent 7890A system. From the friendly, familiar GC and GC/MSD ChemStation and EZChrom Elite chromatography data systems to our groundbreaking new Lab Monitor & Diagnostic Software, you'll find everything designed to help you make the most of every run, and every workday.

If your 7890A GC will be used in a regulated environment, Agilent software can help there, too, with comprehensive features to address the strict regulatory, certification and quality control requirements of your industry.

With the 7890A GC, all of our data systems provide the same level of support

Whether you're using the GC ChemStation, GC/MSD ChemStation, EZChrom Elite or the enterprise-wide Agilent OL system, you can be confident of complete support for your 7890A GC. Just as with our earlier 6890 hardware platform, each of these systems offers the same ease of use for 7890A method development—and fully supports Lab Monitor & Diagnostic Software, as well as productivity improvement with ALS overlap and backflush.

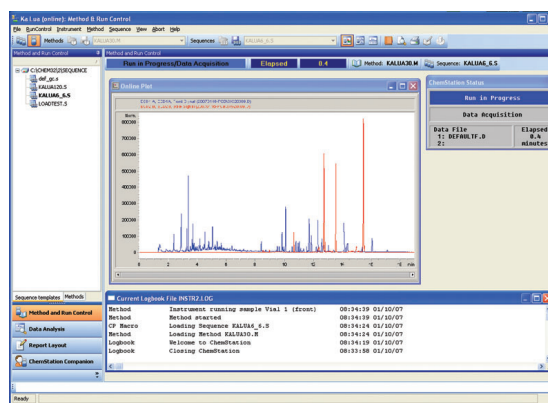

Agilent's industry-leading ChemStation chromatography data system lets you display, calibrate and report data from up to four signals—without having to synchronize separate runs and merge results. This is especially efficient when you need to set up and report complex analyses.

MSD Method Locked to FID Method (Mixture of 25 Pesticides)

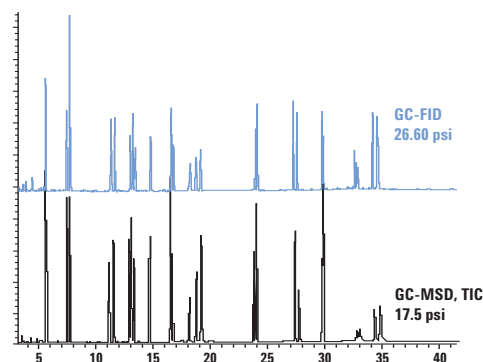

Different Detector, Different Location, Different Operator—Same Results

Retention Time Locking (RTL) software is a powerful productivity tool that lets you reproduce exactly the same results on multiple Agilent GC or GC/MSD systems—configuration to configuration, location to location, operator to operator. This revolutionary Agilent technology allows retention times to be reproduced within hundredths, and even thousandths, of a minute. RTL enables you to more easily and accurately identify peaks, increase sample throughput, reduce the risk of noncompliance, enhance confidence in analytical results—as well as lower your operating costs.

Lab Monitor & Diagnostic Software maximizes uptime by heading off problems before they happen.

Agilent's innovative Lab Monitor & Diagnostic Software continuously monitors a single or multiple Agilent GC and GC/MSD systems in real time to alert you to GC maintenance needs and instrument problems—before your results go bad.

The software also keeps track of injections, hours of operation and other user-specified parameters, and lets you know when it's time to change out consumables or perform basic upkeep tasks, via popup, email or phone text message. It also makes it quick and easy to perform automated diagnostic routines that help to verify proper instrument performance.

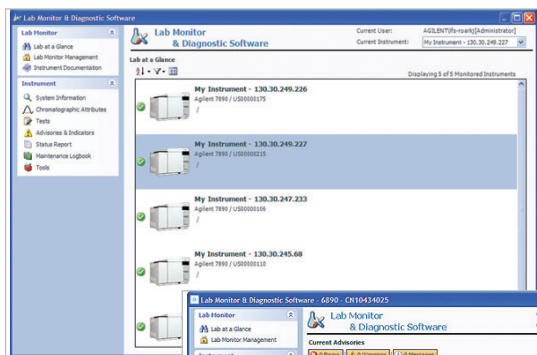

Lab-at-a-Glance feature lets you view the operational status and maintenance needs of a single system or multiple systems lab-wide.

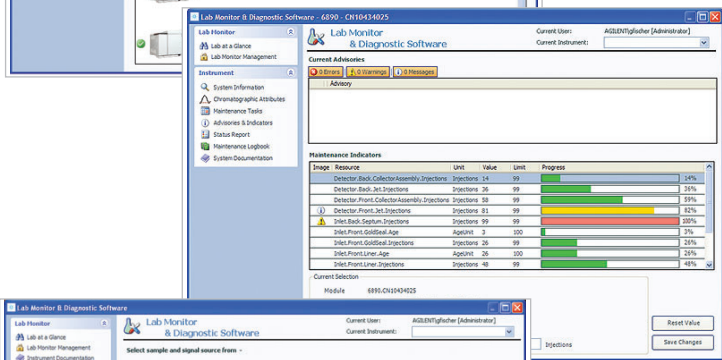

Is it time to change columns or inlet liners? Resource counters and progress bars provide instant visual indication of preventive maintenance needs. So you can be sure you're getting maximum usage from all your consumables.

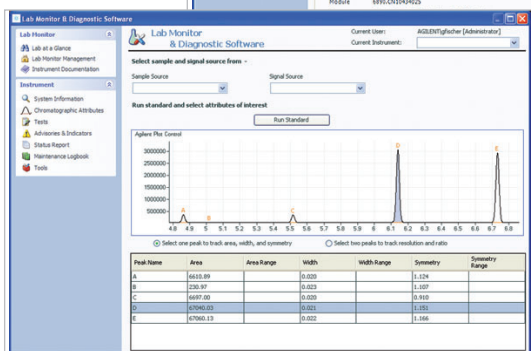

It even keeps an eye on the results. You can also have the software alert you to perform inlet and/or column maintenance when specified chromatographic attributes fall outside preset windows—without the need for subjective interpretation or the intervention of a highly skilled chemist.

Ready for anything your lab can throw at it. Including the future.

The modular, fully automated Agilent 7890A GC system includes the industry's widest selection of inlets, detectors, columns, consumables and sample introduction choices—in fact, everything you need to keep your lab up and running at peak productivity.

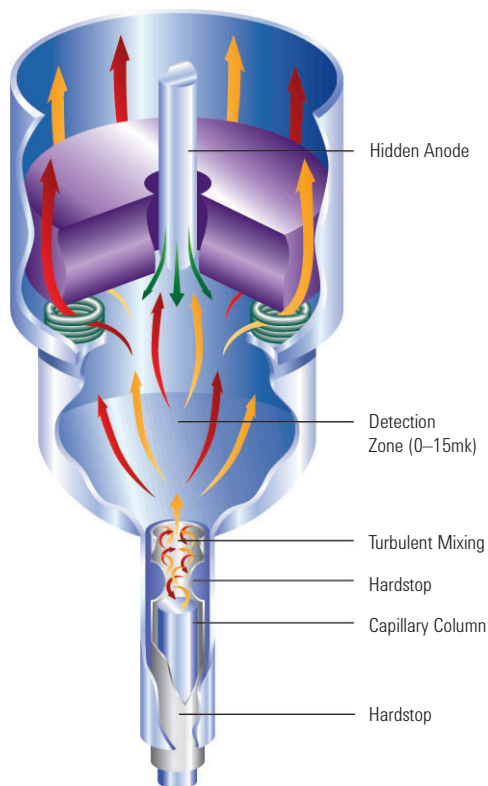

Highest productivity ECD in the business

Agilent's Electron Capture Detector (ECD) combines unprecedented sensitivity and linearity with ruggedness and reliability. So you don't have to concentrate extremely dilute samples, or dilute high-concentration samples to stay within range.

Full dynamic range FID

State-of-the-art digital electrometer enables a linear dynamic range of 10^7 , seamlessly integrated into a single run.

Sensitive and selective element detection

Agilent offers a wide variety of element-sensitive detectors, including a Flame Photometric Detector (FPD) which has been recently improved and is 5x more sensitive for sulfur and 10-15x more sensitive for phosphorous. Sulfur Chemiluminescence Detectors (SCD) provide the highest sensitivity and selectivity for demanding applications.



Looking for the perfect productivity partner for your Agilent 7890A GC?

Add an Agilent 7683 Series Automatic Liquid Sampler. Offering the fastest injection times of any GC autosampler, greater solvent capacity, multiple sampling options, dual simultaneous injection and more, the 7683 ALS is ready to go to work.





Agilent G1888 Headspace Sampler adds to your analysis capabilities

Automatically introduce volatile compounds from virtually any sample matrix directly into a GC or GC/MS. An inert sample pathway provides superior chemical performance without analyte degradation or loss.

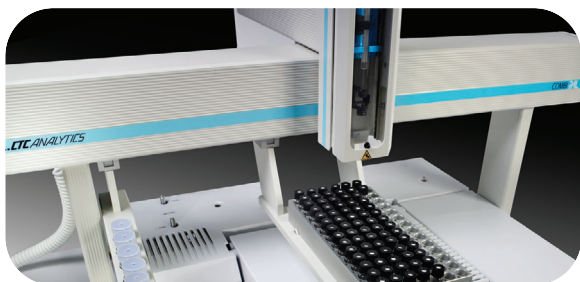

Boost your lab's output with automated sample preparation

Choose the versatile CombiPAL sample injector for liquid injection, headspace and solid-phase microextraction (SPME). The economical GC PAL platform can be configured for liquid injection only, but offers many of the other capabilities of the CombiPAL including large volume injection (LVI), multiple vial sizes and extended sample vial capacity.

High performance Agilent J&W GC columns and supplies to meet every analytical need.

Agilent GC consumables, including our J&W columns, are designed, manufactured and packaged to deliver maximum productivity from your Agilent GC and GC/MSD systems. We strive to provide you with the cleanest, most inert flow path. From our proprietary deactivated inlet liners to our injection-molded inlet gold seal, through the J&W low-bleed columns, your samples are protected from exposure to active sites or outgassed contaminants that can alter your results.





Widest selection of inlets to optimize your separations

- Split/splitless (SSL) capillary
- Packed purged injection port (PIIP)
- Cool on-column (COC)
- Cool on-column with solvent vapor exit (COC-SVE)
- Programmable temperature vaporizing (PTV)
- Volatiles interface (VI)
- High temperature PTV
- High pressure gas sample injection
- LPG direct*
- Temperature-programmable precolumn*

High-sensitivity detectors for every sample type

- Mass selective (Agilent 5975 Series MSD)
- Flame ionization (FID)
- Thermal conductivity (TCD)
- Micro-electron capture (micro-ECD)
- Flame photometric, single- or dual-wavelength (FPD)
- Nitrogen-phosphorus (NPD)
- Sulfur chemiluminescence (SCD)
- Nitrogen chemiluminescence (NCD)
- Atomic emission (AED)*
- Pulsed flame photometric (PFPD)*
- Photoionization (PID)*
- Electrolytic conductivity (ELCD)*
- Discharge ionization (DID)*

*Available through Agilent Channel Partners

Contact Agilent for other custom configurations. A wide variety of additional solutions are available via Agilent's channel partners.

Agilent services let you focus on what you do best

Agilent's service organization is the most respected in the industry. Whether you need support for a single instrument or a multi-laboratory solution, we can help you solve problems quickly, increase your uptime and optimize your lab's resources. We offer:

- On-site preventive maintenance (PM) to ensure dependable operation and minimize unplanned downtime
- Troubleshooting, maintenance and repair for Agilent as well as non-Agilent instruments
- Remote diagnostic and monitoring services to maximize instrument uptime and lab productivity
- Expert consulting and training
- Cooperative support service

The Agilent Value Promise—10 years of guaranteed value.

In addition to continually evolving products, we offer something else unique to the industry—our 10-year value guarantee. The Agilent Value Promise guarantees you at least 10 years of instrument use from your date of purchase, or we will credit you with the residual value of that system toward an upgraded model. Not only does Agilent ensure a safe purchase now, we help ensure your investment is as valuable to you in the long run.

The Agilent Service Guarantee



Should your Agilent instrument require service while covered by an Agilent service agreement, we guarantee repair or we will replace your instrument for free. No other manufacturer or service provider offers this level of commitment to keeping your laboratory running at maximum productivity.

For more information

Learn more:

www.agilent.com/chem/7890A

Buy online:

www.agilent.com/chem/store

Find an Agilent customer center in your country:

www.agilent.com/chem/contactus

U.S. and Canada

1-800-227-9770

agilent_inquiries@agilent.com

Europe

info_agilent@agilent.com

Asia Pacific

adinquiry_aplsca@agilent.com

Research use only. Information, descriptions, and specifications in this publication are subject to change without notice. Agilent Technologies shall not be liable for errors contained herein or for incidental or consequential damages in connection with the furnishing, performance or use of this material.

© Agilent Technologies, Inc. 2007
Printed in USA March 16, 2007
5989-5929EN



Agilent Technologies