

NEW

# ORCA<sup>®</sup>-Quest2

qCMOS<sup>®</sup> camera C15550-22UP



Photon number resolving

**HAMAMATSU**  
PHOTON IS OUR BUSINESS

# Achieves the ultimate in quantitative imaging.

Since the 1980s, Hamamatsu Photonics has continued to develop high-sensitivity, low-noise cameras using its unique camera design technology and has always contributed to the development of cutting-edge scientific and technological research.

With over 40 years of experience, in 2021, Hamamatsu Photonics are proud to have released the ORCA®-Quest with ultimate performance.

The world's first qCMOS® camera

## ORCA®-Quest

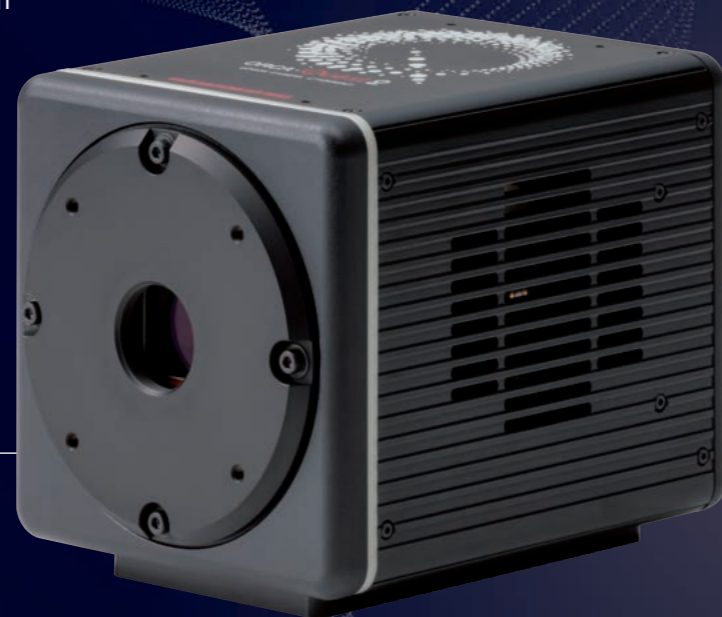

## Evolution from single photon counting to photon number resolving

### What is qCMOS®?

The qCMOS® (Quantitative CMOS) is a CMOS image sensor that has the ability to detect and identify the number of both single and multiple photoelectrons.

ORCA®-Quest is the world's first camera to incorporate the qCMOS® image sensor and to be able to resolve the number of photoelectrons using a newly developed dedicated technology. (See page 8)

## History of high-sensitivity cameras

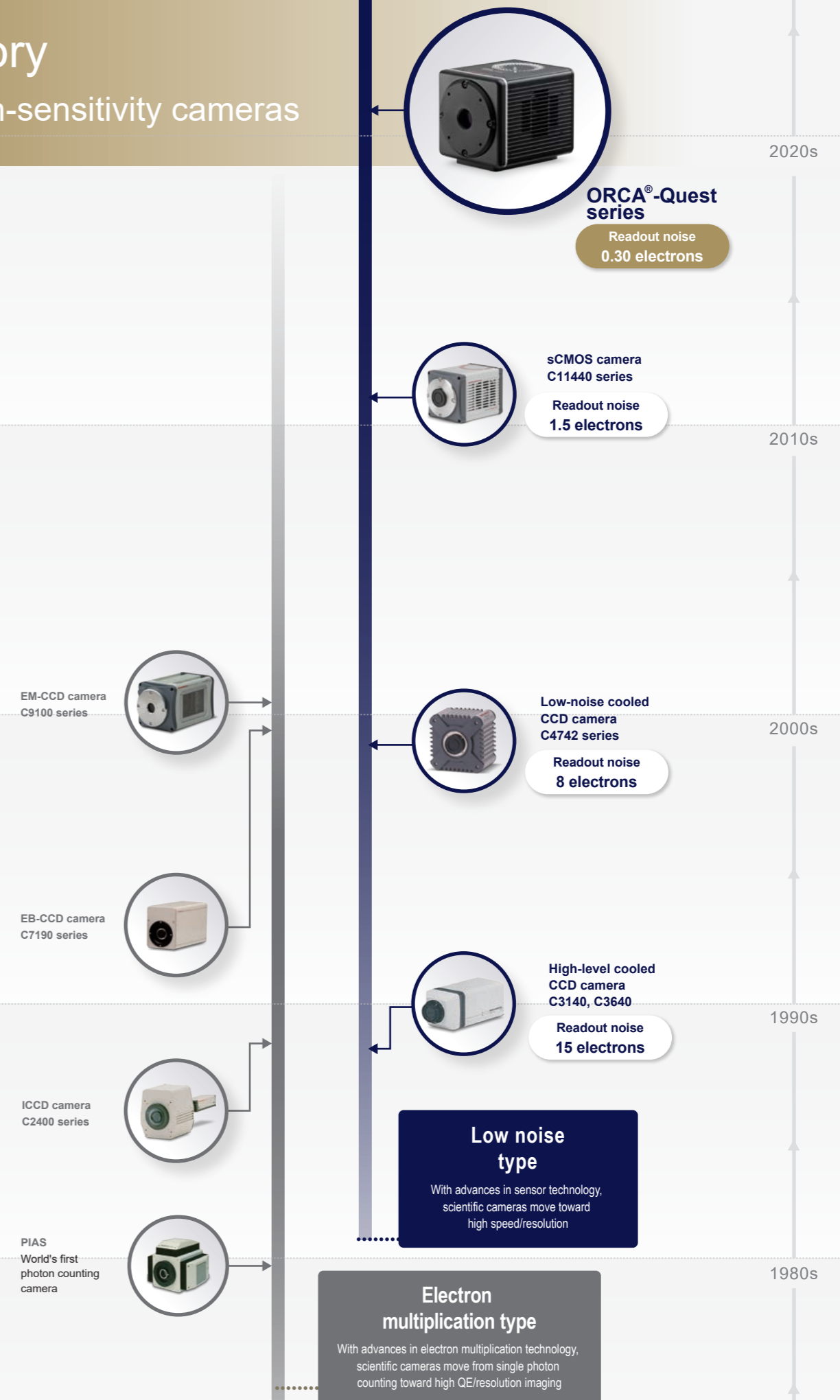

The evolution of qCMOS<sup>®</sup> continues

# ORCA<sup>®</sup>-Quest 2



Evolution from  
ORCA<sup>®</sup>-Quest

## LOW READOUT NOISE AND HIGH SPEED

**0.30** ELECTRONS RMS @ **25 fps**<sup>\*</sup>  
ULTRA QUIET SCAN

**0.43** ELECTRONS RMS @ **120 fps**<sup>\*</sup>  
STANDARD SCAN

## HIGH RESOLUTION

**4096 × 2304**  
9.4 MEGAPIXELS

## HIGH QE

**50 %** @300 nm  
**85 %** @460 nm  
**30 %** @900 nm

<sup>\*</sup> Frame rate value in full resolution

## Faster ultra quiet scan mode

ORCA<sup>®</sup>-Quest had achieved the level to realize photon number resolving owing to ultra-low noise characteristic in ultra quiet scan mode. However, this availability was limited for users because the ultra-low noise was available only when the camera operated in 5 frame per second (in full resolution). ORCA<sup>®</sup>-Quest 2 has achieved 5 times faster framerate with a similar ultra-low noise characteristic by optimizing the sensor operation. Photon number resolving feature has become available for most of users now!

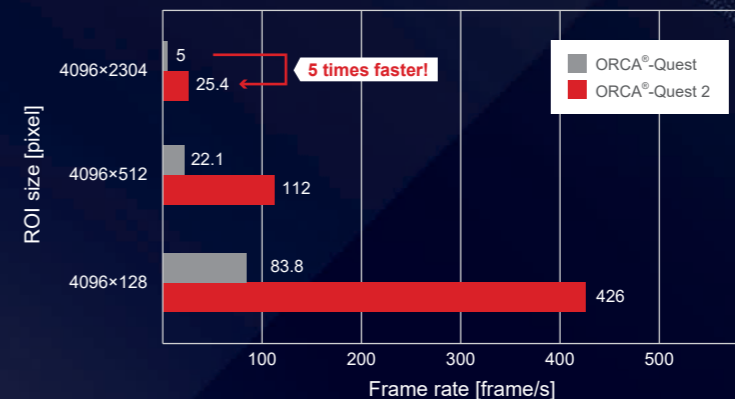

## UV QE improvement

ORCA<sup>®</sup>-Quest possessed high quantum efficiency (QE) in UV region around 280 nm-400 nm, compared to most of conventional scientific cameras. Inspired by market needs, ORCA<sup>®</sup>-Quest 2 has achieved even higher UV QE by optimizing AR coating of the sensor window, with no change of visible, near infrared wavelength region. The QE improvement expands the versatility of ORCA<sup>®</sup>-Quest series in many kinds of application such as trapped ion quantum experiment.

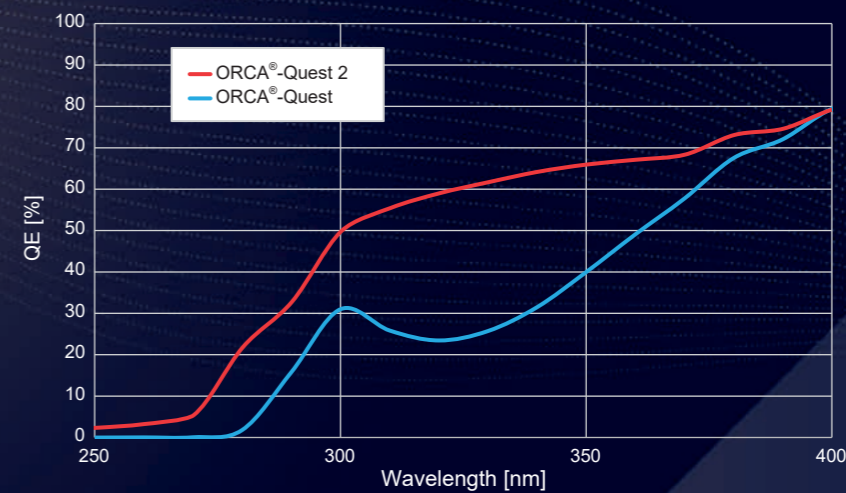

## Raw data output

The feature allows you to apply any algorithms to estimate the number of photoelectron from raw digital signal.

## Faster edge trigger mode

The new edge trigger mode enables you to input an external trigger and start exposure during rolling shutter readout, resulting in a faster frame rate.

# Four key features that enable the ORCA<sup>®</sup>-Quest 2 to achieve ultimate quantitative imaging

1. Extreme low-noise performance
2. Realization of photon number resolving (PNR) output
3. Back-illuminated structure and high resolution
4. Realization of a large number of pixels and high speed readout

## 1. Extreme low-noise performance

### Ultra-low readout noise 0.30 electrons rms at Ultra quiet scan

In order to detect weak light with high signal-to-noise, ORCA<sup>®</sup>-Quest 2 has been designed and optimized to every aspect of the sensor from its structure to its electronics. Not only the camera development but also the custom sensor development has been done with latest CMOS technology, an extremely low noise performance of 0.30 electrons has been achieved.

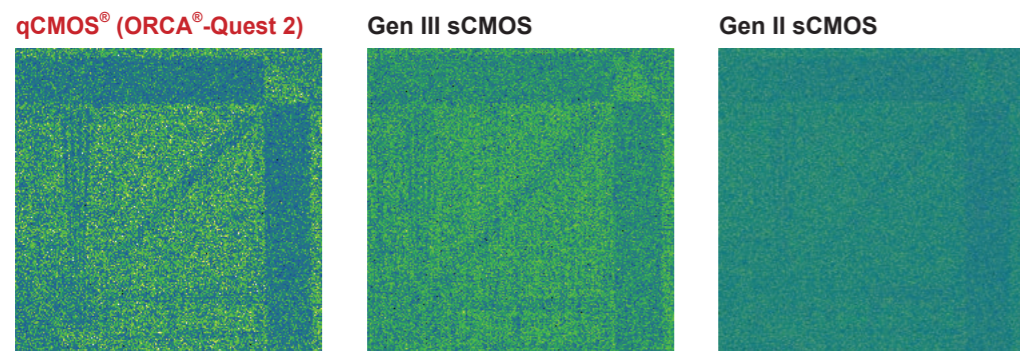
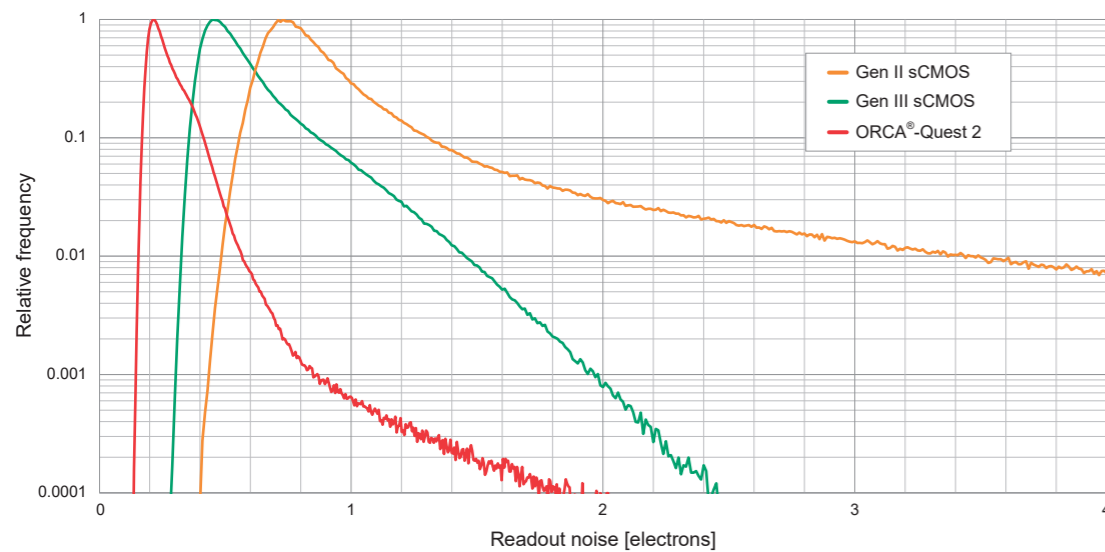

Comparison of average 1 photon per pixel image (pseudo-color)  
Exposure time: 200 ms LUT: minimum to maximum value Comparison area: 512 pixels × 512 pixels

### Low-dark current 0.006 electrons/pixel/s at -35 °C

In the field of single photon counting and photon number resolving, even dark currents as low as 0.5 electrons/pixel/s can affect photon detection. The 0.006 electrons/pixel/s @-35 °C value achieved by ORCA<sup>®</sup>-Quest 2 is an extremely low probabilistic value of only 1 electrons of dark current generated in approximately 167 pixels when exposed for 1 second.

Thus, the ORCA<sup>®</sup>-Quest 2, which is less affected by dark current, is ideal for quantitative imaging and analysis.

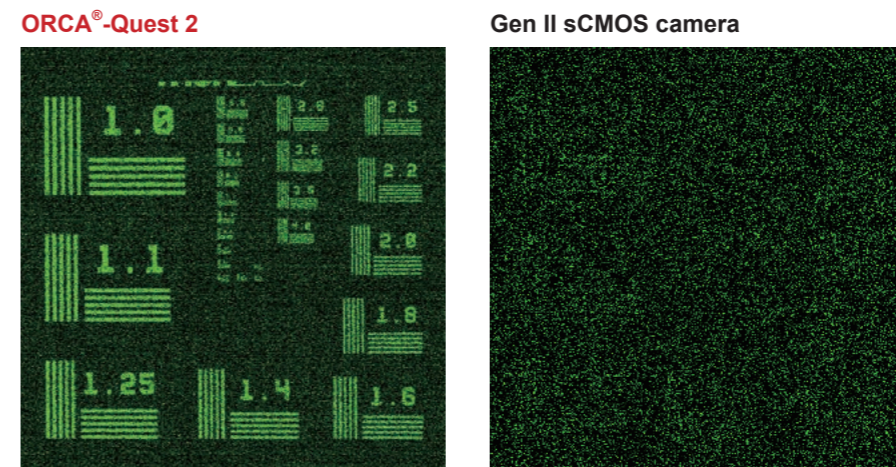

Image quality comparison at long exposure time (pseudo-color)  
Incident light intensity: 0.05 photons/pixel/s Exposure time: 15 min (10 s × 90 times integration)

### Cosmic-ray effects in long-time exposure

When performing long-time exposure, conventional EM-CCD cameras are easily affected by cosmic rays, and the resulting white spots have become a problem. ORCA<sup>®</sup>-Quest 2 is not easily affected by cosmic rays and can suppress the deterioration of image quality due to white spots during long-time exposure.

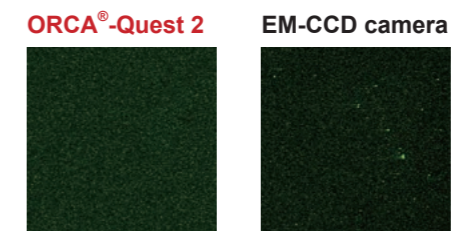

Image quality comparison at long exposure time (pseudo-color)  
No incident light Exposure time: 30 min

# Four key features that enable the ORCA<sup>®</sup>-Quest 2 to achieve ultimate quantitative imaging

1. Extreme low-noise performance
2. Realization of photon number resolving (PNR) output
3. Back-illuminated structure and high resolution
4. Realization of a large number of pixels and high speed readout

## 2. Realization of photon number resolving (PNR) output

### Realization of photon number resolving by low-readout noise

Light is a collection of many photons. Photons are converted into electrons on the sensor, and these electrons are called photoelectrons. "Photon number resolving" is a method of accurately measuring light by counting photoelectrons.\*

In order to count these photoelectrons, camera noise must be sufficiently smaller than the amount of photoelectron signal. Conventional sCMOS cameras achieve a small readout noise, but still larger than photoelectron signal, making it difficult to count photoelectrons.

Using advanced camera technology, the ORCA<sup>®</sup>-Quest 2 counts photoelectrons and delivers an ultra-low readout noise of 0.30 electrons rms (@Ultra quiet scan), stability over temperature and time, individual calibration and real-time correction of each pixel value.

For more information about the qCMOS<sup>®</sup> image sensor, please refer to the ORCA<sup>®</sup>-Quest white paper.

**Simulation data of photoelectron probability distribution** (Average number of photoelectrons generated per pixel: 2 electrons)

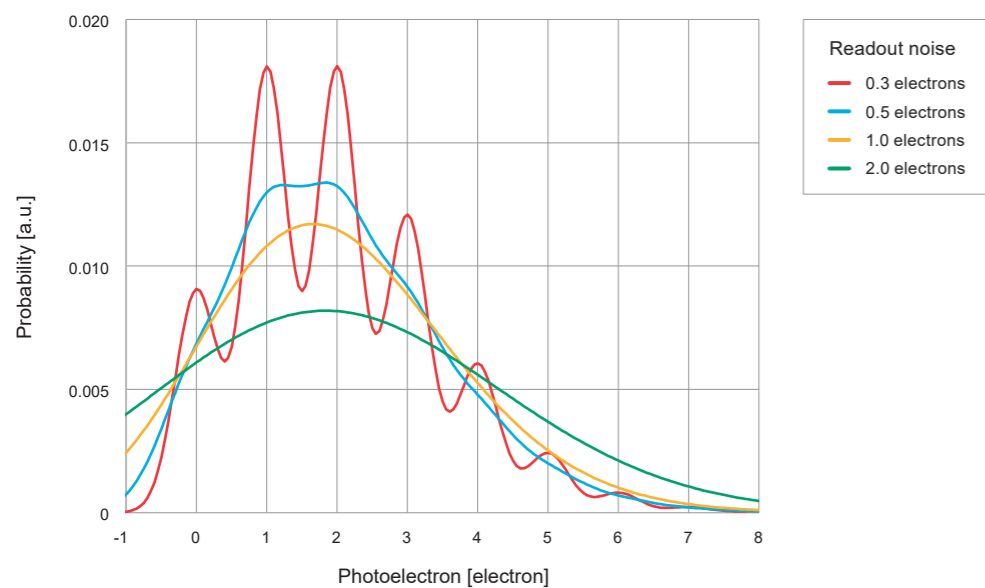

\* Photon number resolving is unique and quite different from photon counting (More precisely the method resolves the number of photoelectrons. However, since single photon counting instead of single photoelectron counting has been used for a comparable method in this field, we will use the term "photon number resolving" in this brochure).

### Spatial photon number resolving capability

The graphs show simulated histograms when averaged photoelectrons are 3 and 10 electrons/pixel. While the EM-CCD and Gen II sCMOS cameras cannot realize the photon number resolving due to multiplication noise or higher readout noise, the ORCA<sup>®</sup>-Quest 2 realizes spatial photon number resolving in addition to temporal photon number resolving. Furthermore, it follows Poisson distributions corresponding with averaged photoelectrons of 3 and 10 electrons/pixel.

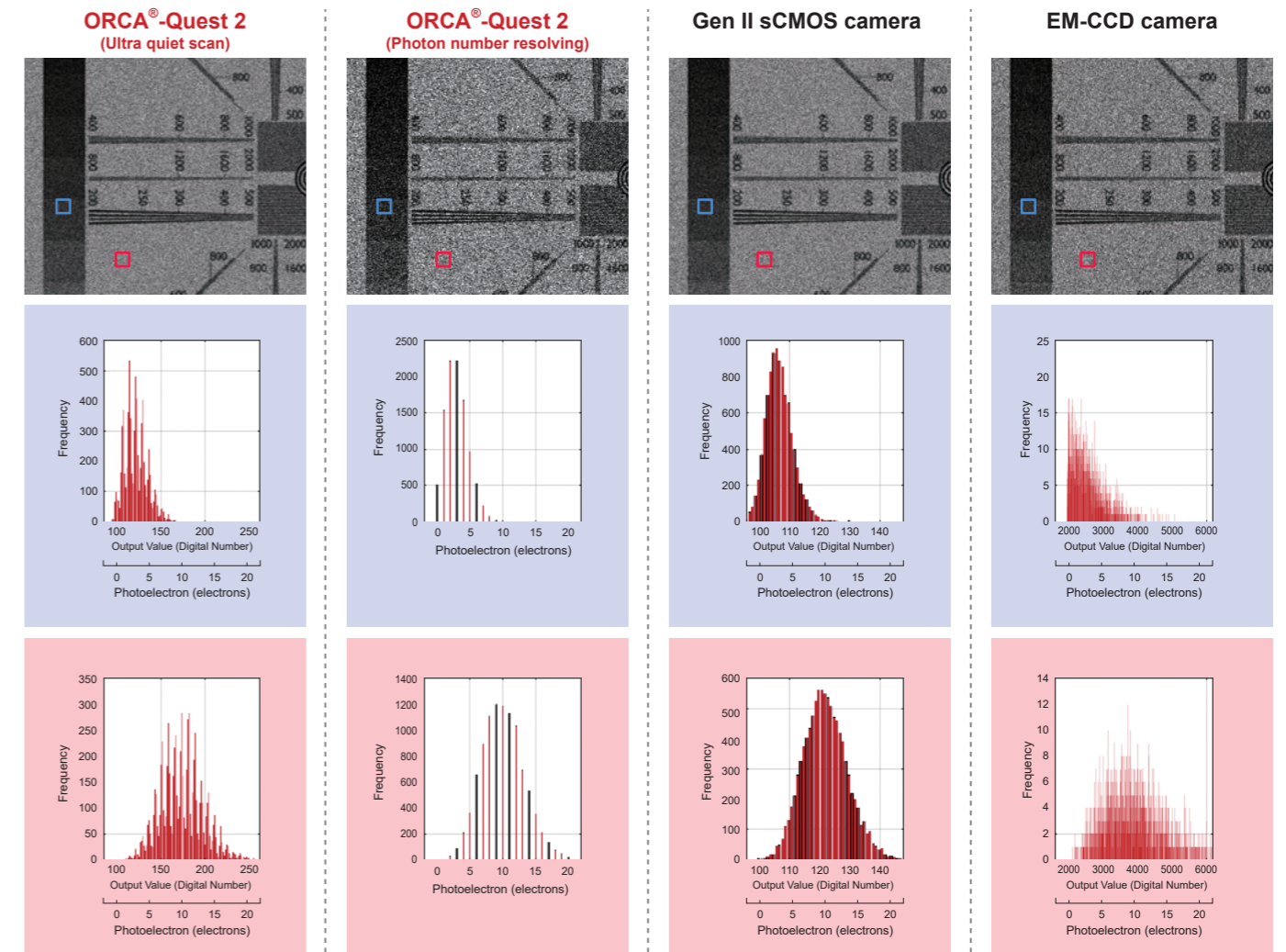

■ Average number of photoelectrons generated per pixel: 3 electrons  
■ Average number of photoelectrons generated per pixel: 10 electrons

# Four key features that enable the ORCA<sup>®</sup>-Quest 2 to achieve ultimate quantitative imaging

1. Extreme low-noise performance
2. Realization of photon number resolving (PNR) output
3. Back-illuminated structure and high resolution
4. Realization of a large number of pixels and high speed readout

## 3. Back-illuminated structure and high resolution

### Trench structure to suppress crosstalk

High QE is essential for high efficiency of detecting photons and achieved by back-illuminated structure. In conventional back-illuminated sensors, crosstalks occur between pixels due to no pixel separation, and resolutions are usually inferior to those of front-illuminated sensors. The ORCA<sup>®</sup>-Quest 2 qCMOS<sup>®</sup>s sensor has back-illuminated structure for achieving high quantum efficiency, and trench structure in one-by-one pixel for reducing crosstalk.

#### What is a trench structure?

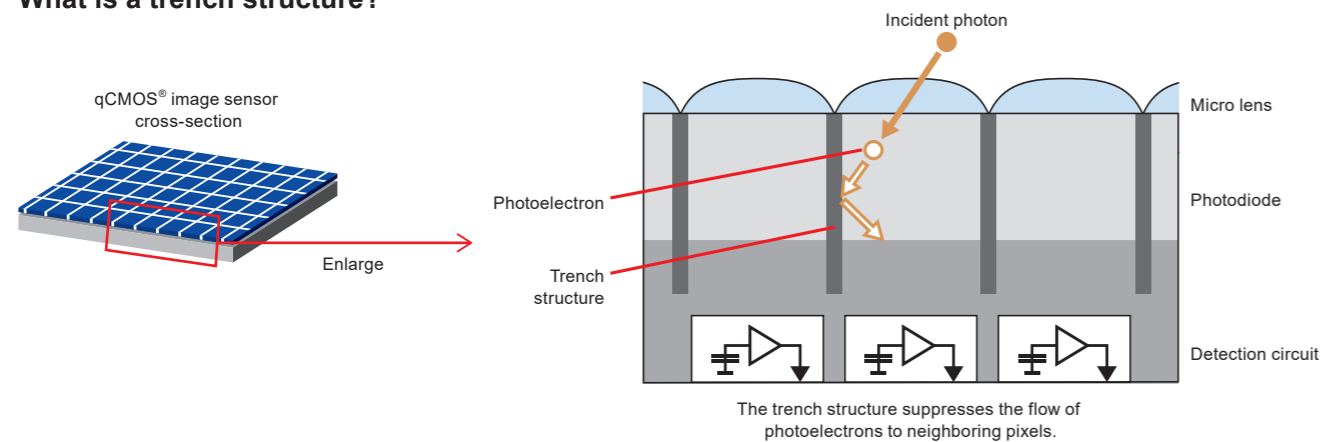

#### Measurement result of MTF

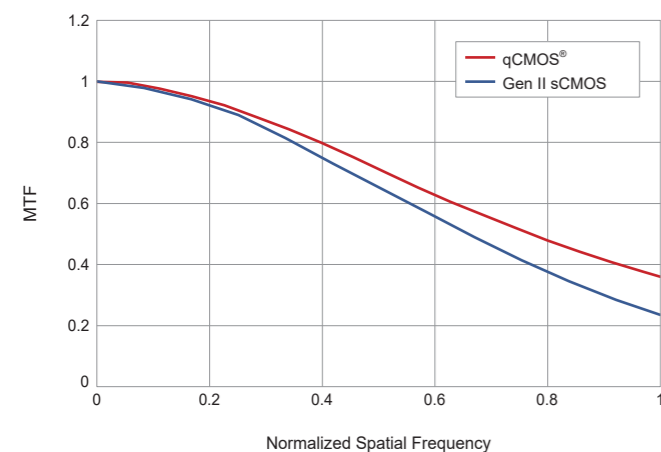

Modulation Transfer Function (MTF) is a type of resolution evaluation. It is the value of how accurately the contrast of an object can be reproduced.

### High QE 50 % @300 nm, 85 % @460 nm, 30 % @900 nm

It also has high quantum efficiency in the near-infrared region because of its thicker layer of the charge detection region. Normally, there is a trade-off between the thickness of the layer of the photon detection region and the resolution, but the trench structure suppresses the degradation of the resolution.

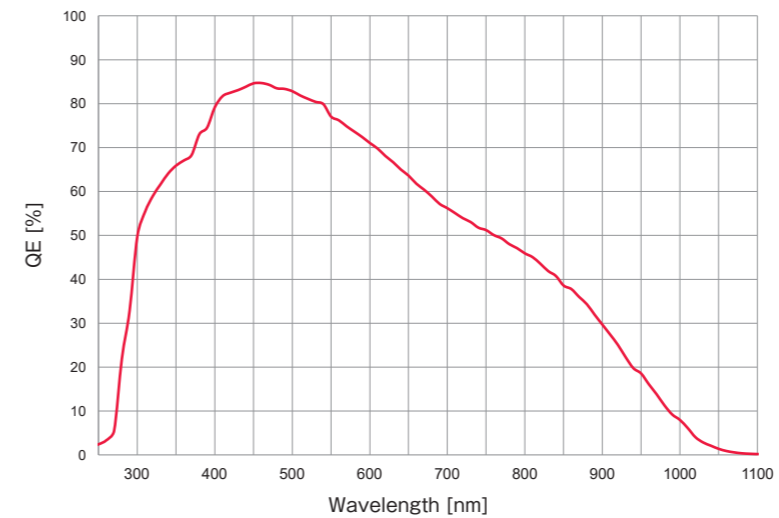

### Etaloning-desensitized

Etaloning is a phenomenon that occurs when the incident light interferes with the reflected light from the back surface of the silicon and causes varying sensitivity dependent both on the spatial and the spectral position. In the case of an EM-CCD camera, it appears as a fringe pattern even with uniform monochrome light input, mostly in the IR. The qCMOS<sup>®</sup> camera shows minimal etaloning compared to EM-CCD cameras.

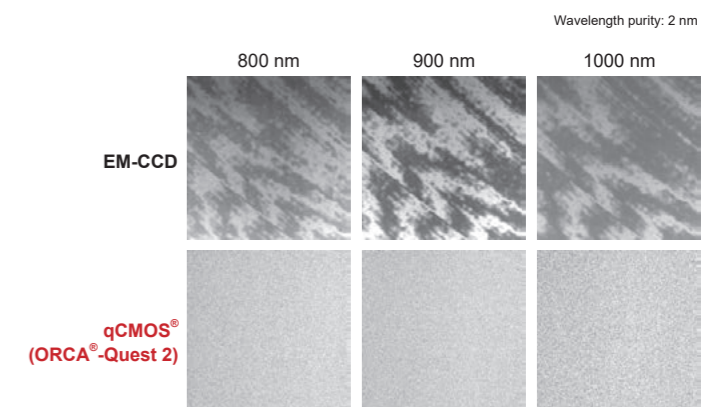

# Four key features that enable the ORCA<sup>®</sup>-Quest 2 to achieve ultimate quantitative imaging

1. Extreme low-noise performance
2. Realization of photon number resolving (PNR) output
3. Back-illuminated structure and high resolution
4. Realization of a large number of pixels and high speed readout

## 4. Realization of a large number of pixels and high speed readout

### Coexistence of quantitative imaging, many pixels, and high speed

ORCA<sup>®</sup>-Quest 2 realizes ultra-low noise with 9.4 megapixels (4096 (H) × 2304 (V)). ORCA<sup>®</sup>-Quest 2 is capable of capturing a larger number of objects, compared to conventional scientific cameras like Gen II sCMOS and EM-CCD camera.

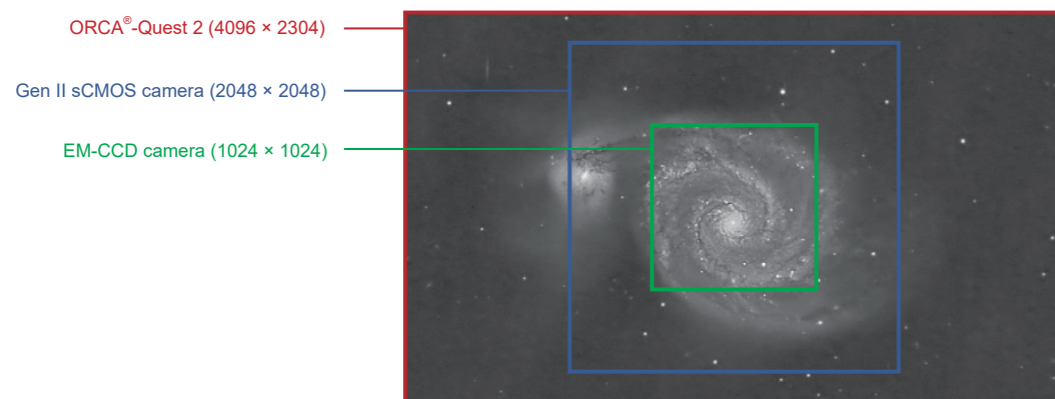

In addition, ORCA<sup>®</sup>-Quest 2 has outstanding performance in terms of its readout speed. Here, we refer to “data rate (number of pixels × frame rate)”, which represents how many pixels a camera read out in 1 second, for comparison among scientific cameras. ORCA<sup>®</sup>-Quest 2 with Standard scan realizes higher data rate even with lower readout noise than conventional sCMOS cameras. Also, ORCA<sup>®</sup>-Quest 2 with Ultraquiet scan realizes photon number resolving imaging with 10 times faster data rate than single photon counting imaging by EM-CCD cameras.

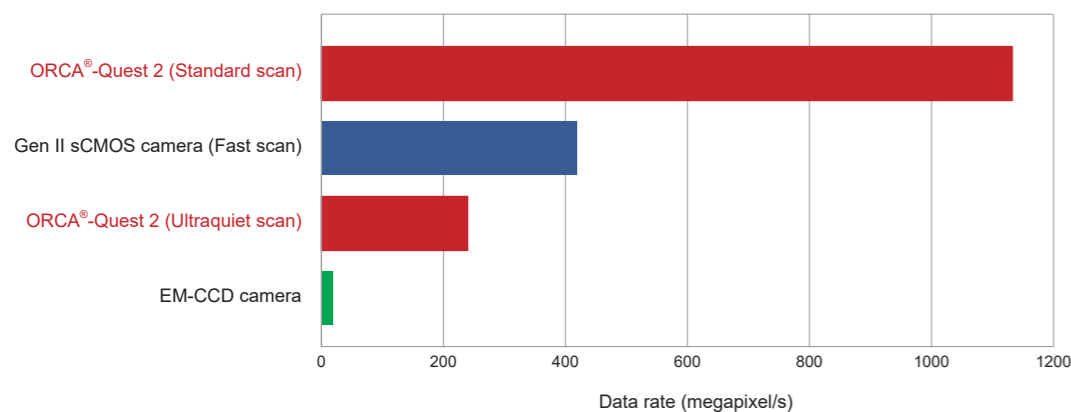

### Fast readout speed available with subarray

Faster frame rate is available in ORCA<sup>®</sup>-Quest 2 with subarray function (ROI).

#### Readout speed (frames/s) in Area Readout Mode

##### Standard scan

Number of pixels		Readout speed (frames/s)		
X (pixels)	Y (pixels)	CoaXPRESS	USB3.1 Gen I (16 bit)	USB3.1 Gen I (8 bit)
4096	2304	120	17.6	35.3
4096	2048	134	19.9	39.8
4096	1024	268	39.6	79.3
4096	512	532	78.9	157
4096	256	1040	156	312
4096	128	2012	304	609
4096	64	3750	583	1160
4096	32	6610	1060	2130
4096	16	10600	1850	3650
4096	8	15400	2890	5780
4096	4	19800	4080	8160

##### Ultra quiet scan

Number of pixels		Readout speed (frames/s)		
X (pixels)	Y (pixels)	CoaXPRESS	USB3.1 Gen I (16 bit)	USB3.1 Gen I (8 bit)
4096	2304	25.4	17.6	25.4
4096	2048	28.6	19.9	28.6
4096	1024	56.9	39.6	56.9
4096	512	112	78.7	112
4096	256	221	155	221
4096	128	426	303	426
4096	64	796	577	796
4096	32	1400	1050	1400
4096	16	2260	1840	2260
4096	8	3270	2670	3270
4096	4	4200	3680	4200

### Sensor sizes that can be used with general-purpose optical systems

As the number of pixels increases, the size of the sensor also increases, resulting in cases where the peripheral field of view is missing when using optics such as under a microscope. The ORCA<sup>®</sup>-Quest 2 has 18.841 mm (H) × 10.598 mm (V) by 9.4 megapixels, 4.6 μm px size, that fits in a C-mount of dia. 25.4 mm, making it suitable for use with general-purpose optics.

\* An F-mount option is also available.

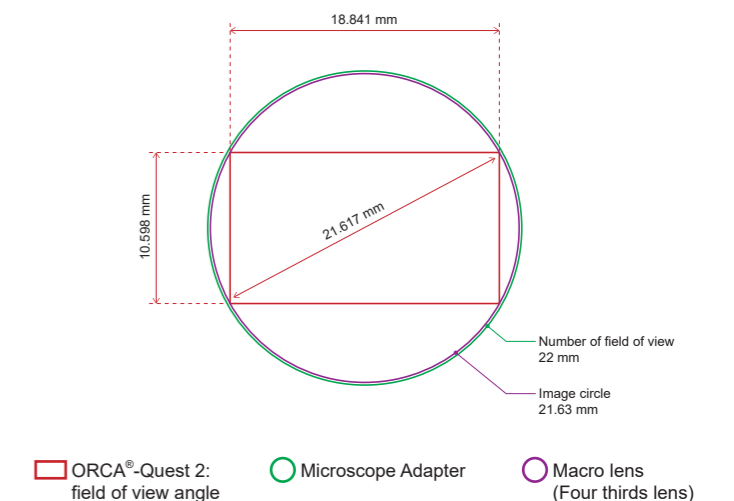

# Application and Measurement Examples

## Quantum technology

### Neutral atom, Trapped ion

Neutral atoms and ions are aligned one by one in an array to be utilized as Qubits for Quantum computing. The qubit states can be determined by observing the fluorescence from each of them. The measurement of the fluorescence needs to be done in short time and then photodetectors with very low noise and high speed are needed. ORCA<sup>®</sup>-Quest 2 can do both of diagnosis of the whole qubit array and state detection of each qubit with very low noise characteristics and high speed readout. Also, the QE covers wide range of wavelength for major ion and atom species.

### Fluorescence imaging of Rb atom array with ORCA<sup>®</sup>-Quest

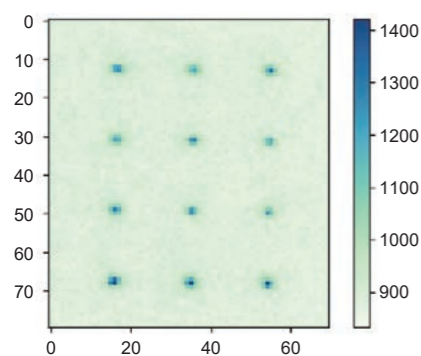

Data courtesy of: Takashi Yamamoto and Asst. Prof. Toshiki Kobayashi, Osaka University

Reference : [https://camera.hamamatsu.com/all/en/application\\_and\\_case\\_study/quantum\\_technology/Imaging\\_single\\_atom\\_array\\_by\\_orca\\_quest.html](https://camera.hamamatsu.com/all/en/application_and_case_study/quantum_technology/Imaging_single_atom_array_by_orca_quest.html)

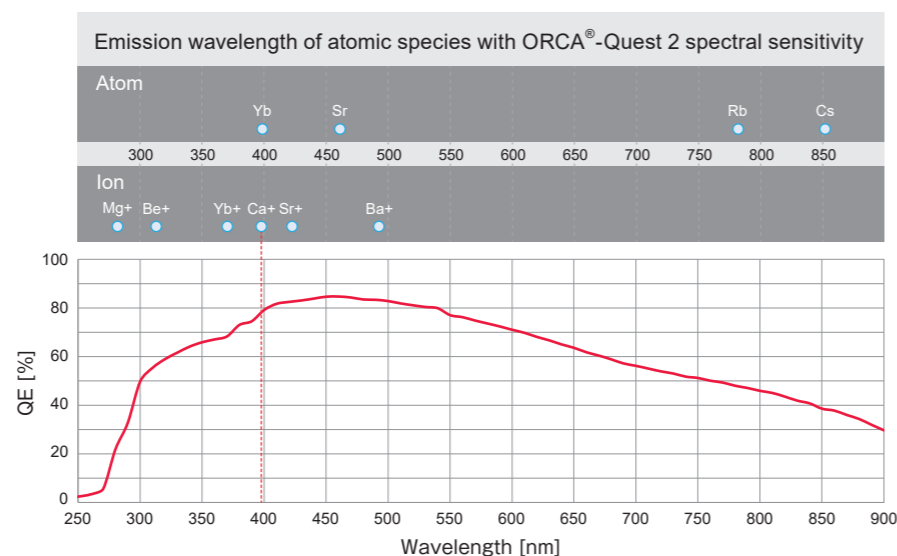

## Quantum optics

Quantum optics uses single photon sources to make use of the Quantum nature of the single photon. The quantum optics research also uses single photon counting detectors, and now there are emerging needs of photon number resolving detectors to distinguish photon numbers coming into the detectors. A photon counting camera, a new concept in camera technologies, is expected to make a new discovery in this field.

### Experimental setup and images of Quantum imaging with ORCA<sup>®</sup>-Quest

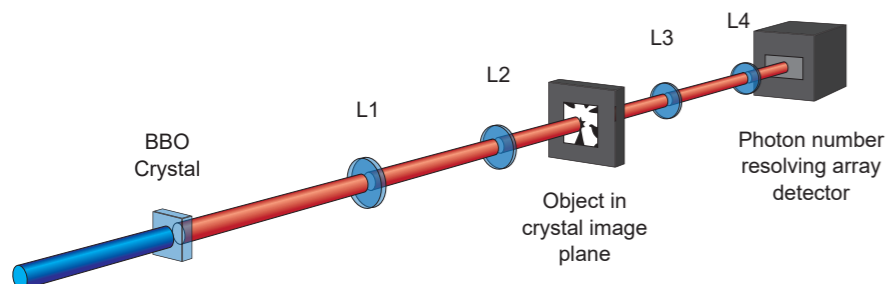

Data courtesy of: Miles Padgett, University of Glasgow  
Reference : <https://www.nature.com/articles/s41598-022-10037-x>

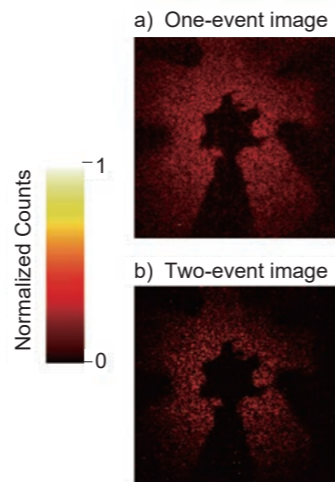

## Life science

### Bioluminescence

Bioluminescence microscopy has been gaining attentions because of the unique advantages against the conventional fluorescence microscopy, such as no need of excitation light. The major drawback of the bioluminescence is its very low light intensity, resulting in long exposure time and low image quality. The bioluminescence research needs highly sensitive cameras even in long exposure.

### Simultaneous dual wavelength luminescence imaging (ORCA<sup>®</sup>-Quest + W-VIEW GEMINI)

Overall image in the field of view

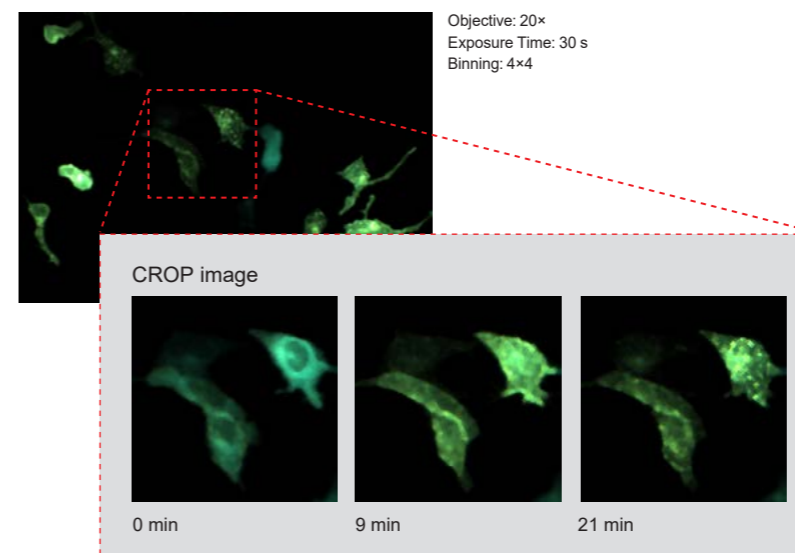

Appearance of the microscope system



NanoLuc fusion protein ARRB2 and Venus fusion protein V2R are nearby and BRET is occurring.

Data courtesy of: Dr.Masataka Yanagawa, Department of Molecular & Cellular Biochemistry Graduate School of Pharmaceutical Science, Tohoku University

## Super resolution microscopy

Super resolution microscopy refers to a collection of methods to get a microscope image with higher spatial resolution than diffraction limit. The super resolution microscopy needs scientific cameras with combination of very low noise and small pixel size, resulting in a higher resolution.

### Super resolution images from ORCA<sup>®</sup>-Quest and ORCA<sup>®</sup>-Fusion

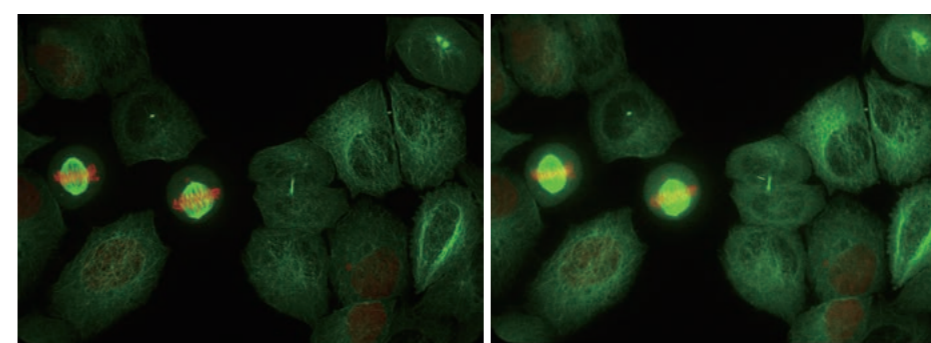

**ORCA<sup>®</sup>-Quest**  
(qCMOS<sup>®</sup> camera, 4.6 μm pixel size)

**ORCA<sup>®</sup>-Fusion**  
(Gen III sCMOS camera, 6.5 μm pixel size)

Provided by Steven Coleman at Visitech international with their VT-iSIM, high speed super resolution live cell imaging system.

Experimental setup with ORCA<sup>®</sup>-Quest

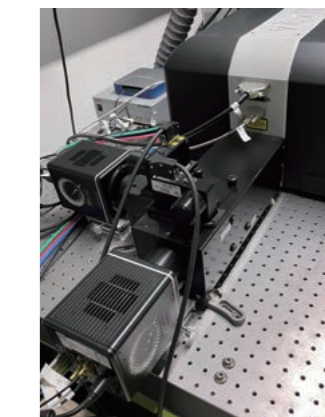



# Application and Measurement Examples

## Astronomy

### Lucky imaging

When observing stars from the ground, the image of the star can be blurred due to atmospheric turbulence therefore substantially reducing the ability to capture clear images.

However, with short exposures and the right atmospheric conditions, you can sometimes capture clear images. For this reason, lucky imaging is a method of acquiring a large number of images and integrating only the clearest ones while aligning them.

### Orion Nebula (Color image with 3 wavelength filters)

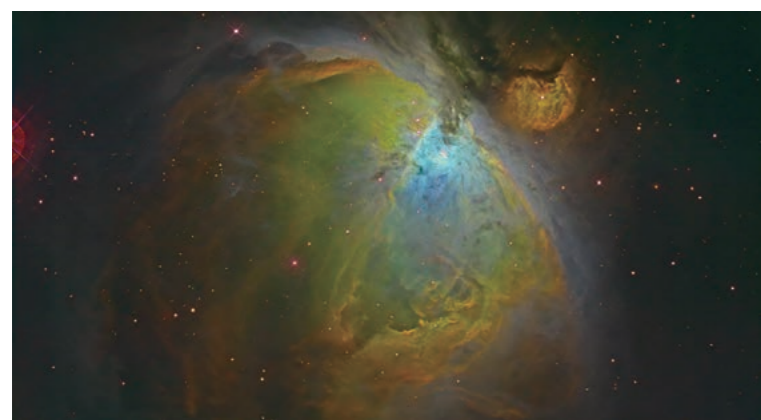

Imaging setup



### Adaptive optics

Adaptive optics is a method where systems immediately correct the wavefront of incoming light which is disturbed by atmospheric fluctuations. In order to perform real-time and highly accurate wavefront correction, a camera needs to get images with high speed and high spatial resolution. In addition, the camera also needs high sensitivity because the wavefront correction is performed in a very dark condition where a laser guide star is measured.

### Wavefront correction by adaptive optics

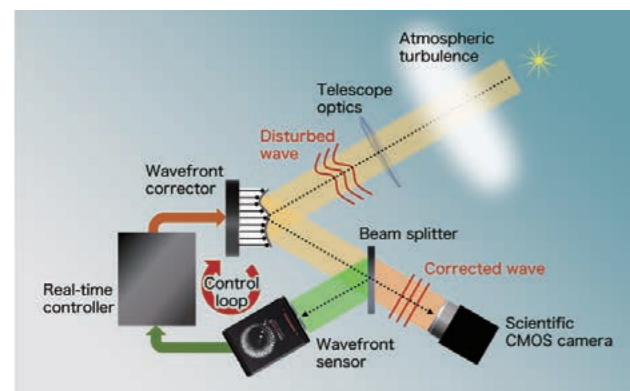

### Comparison of adaptive optics\*

With adaptive optics

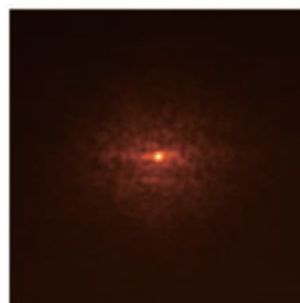

Without adaptive optics

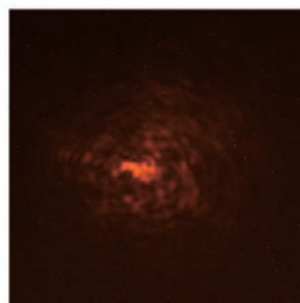

Conditions: wind speed 10 m/s, exposure time 6 seconds in the laboratory  
\*Data courtesy of: Kodai Yamamoto, Ph.D., Department of Astronomy, Kyoto University

## HEP / Synchrotron

For imaging of X-ray or other kinds of high energy particles, a scientific camera coupled with a scintillator is often used. Low noise and high speed are required in the imaging system to detect momentary phenomena.

### X-ray phase contrast CT image of mouse embryo

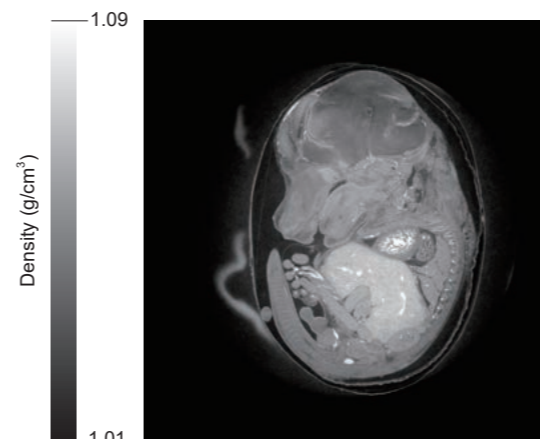

Experimental setup

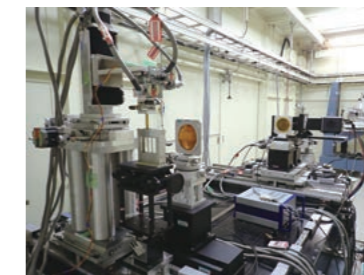

Camera setup

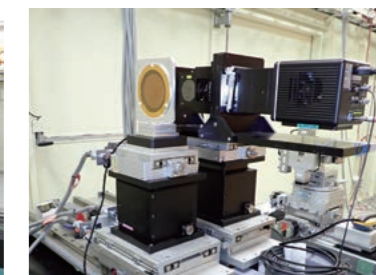

- X-ray phase contrast CT image of mouse embryo from ORCA<sup>®</sup>-Quest combined with High resolution X-ray imaging system (M11427)
- Exposure time: 15 ms, Total measurement time: 6.5 min
- Data courtesy of: SPring-8 BL20B2 beamline by Dr. Masato Hoshino, Senior researcher in Japan Synchrotron Radiation Research Institute (JASRI)

## Raman spectroscopy

Raman effect is the scattering of light at a wavelength different from that of the incident light, and Raman spectroscopy is a technique for determining the material properties by measuring this wavelength. Raman spectroscopy enables structural analysis at the molecular level, which provides information on chemical bonding, crystallinity, etc.

### Raman spectrum (single frame) comparison under condition of equal photon number per pixel in line scan type Raman imaging system

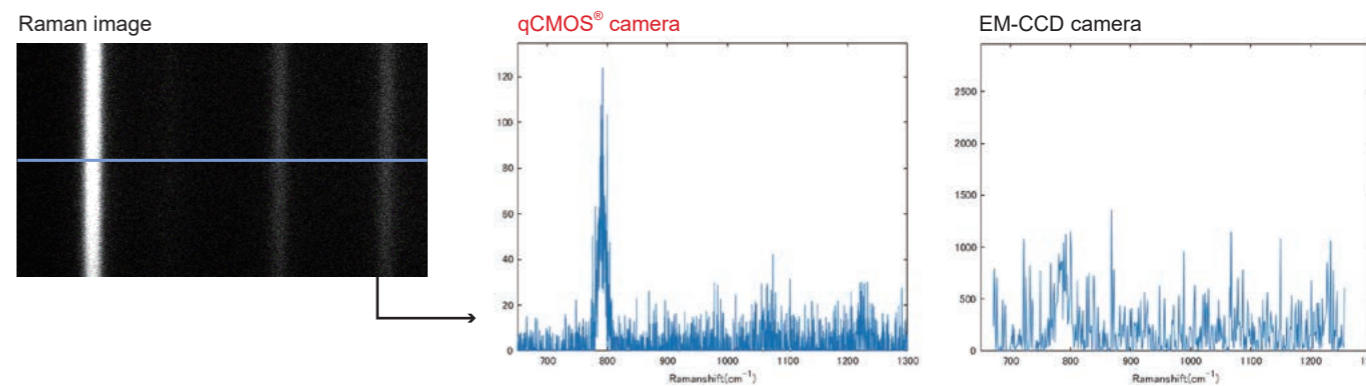

@10 photon/pixel/frame, 532 nm laser excitation  
Reference: [https://camera.hamamatsu.com/all/en/application\\_and\\_case\\_study/spectroscopy/photon\\_number\\_resolving\\_capability.html](https://camera.hamamatsu.com/all/en/application_and_case_study/spectroscopy/photon_number_resolving_capability.html)

Case studies are now available on our website!

[https://camera.hamamatsu.com/all/en/application\\_and\\_case\\_study.html](https://camera.hamamatsu.com/all/en/application_and_case_study.html)



# Specification

Product number	C15550-22UP	
Imaging device	qCMOS <sup>®</sup> image sensor	
Effective number of pixels	4096 (H) × 2304 (V)	
Pixel size	4.6 μm (H) × 4.6 μm (V)	
Effective area	18.841 mm (H) × 10.598 mm (V)	
Quantum efficiency (typ.)	85 % (peak QE)	
Full well capacity (typ.)	7000 electrons	
Readout noise (typ.)	Standard scan	0.43 electrons (rms), 0.39 electrons (median)
	Ultra quiet scan	0.30 electrons (rms), 0.25 electrons (median)
Dynamic range (typ.) *1	23 000 : 1 (rms), 28 000 : 1 (median)	
Dark signal non-uniformity (DSNU) (typ.) *2	0.06 electrons	
Photoresponse non-uniformity (PRNU) (typ.) *2*3	<0.1 %	
Linearity error	EMVA 1288 standard (typ.)	0.5 %
<b>Cooling</b>		
Sensor temperature		Dark current (typ.)
Forced-air cooled (Ambient temperature: +25 °C)	-20 °C	0.016 electrons/pixels/s
Water cooled (Water temperature: +25 °C) *4	-20 °C	0.016 electrons/pixels/s
Water cooled [max cooling (Water temperature: +20 °C, Ambient temperature: +20 °C)] *4	-35 °C (typ.)	0.006 electrons/pixels/s

At Normal area readout, Photon number resolving (PNR), and Raw data output (Raw) mode*5		
Readout mode	Full resolution, Digital binning (2×2, 4×4), Sub-array	
Frame rate at full resolution	Standard scan *6	120 frames/s (CoaXPress), 17.6 frames/s (USB)
	Ultra quiet scan, PNR, Raw	25.4 frames/s (CoaXPress), 17.6 frames/s (USB)
Exposure time	Standard scan *6	7.2 μs to 1800 s
	Ultra quiet scan, PNR, Raw	33.9 μs to 1800 s
Trigger input	External trigger input mode	Edge / Global reset edge / Level / Global reset level / Sync readout / Start
	Software trigger	Edge / Global reset edge / Start
	Trigger delay function	0 s to 10 s in 1 μs steps

At Lightsheet readout (Patented) *7 *8		
Readout mode	Full resolution, Sub-array	
Readout direction	Forward readout / Backward readout / Bidirectional readout / Reverse bidirectional readout	
Row interval time	7.2 μs to 237.6 μs	
Exposure time	7.2 μs to 273.7 ms	
Trigger input	External trigger input mode	Edge / Start
	Software trigger	Edge / Start
	Trigger delay function	0 s to 10 s in 1 μs steps

Trigger output	Global exposure timing output / Any-row exposure timing output / Trigger ready output / 3 programmable timing outputs / High output / Low output	
Master pulse	Pulse mode	Free running / Start trigger / Burst
	Pulse interval	5 μs to 10 s in 1 μs step
	Burst count	1 to 65 535
Digital output	16 bit / 12 bit / 8 bit	
Image processing function	Defect pixel correction (ON or OFF, hot pixel correction 3 steps)	
Emulation mode	Available (ORCA <sup>®</sup> -Quest, ORCA <sup>®</sup> -Fusion)	
Interface	USB 3.1 Gen 1, CoaXPress (Quad CXP-6)	
Trigger input connector	SMA	
Trigger output connector	SMA	
Lens mount	C-mount *9	
Power supply	AC100 V to AC240 V, 50 Hz/60 Hz	
Power consumption	Approx. 155 VA	
Ambient operating temperature	0 °C to +40 °C	
Ambient operating humidity	30 % to 80 % (With no condensation)	
Ambient storage temperature	-10 °C to +50 °C	
Ambient storage humidity	90 % Max. (With no condensation)	

\*1: Calculated from the ratio of the full well capacity and the readout noise in Ultra quiet scan  
 \*2: In Ultra quiet scan  
 \*3: At 3500 electrons, the center 1500 × 1500 area of the image sensor, 1000 times integration  
 \*4: Water volume is 0.46 L/m.  
 \*5: PNR mode and Raw mode can be switched via DCAM configurator. The PNR mode is selected by default.  
 \*6: Normal area readout mode only  
 \*7: Software such as HCLImage is required. For details, please contact your local Hamamatsu representative or distributor.  
 \*8: For more patent information, please refer to our website. <https://www.hamamatsu.com/all/en/product/cameras/cmcs-cameras/lightsheet-readout-mode.html>  
 \*9: A product for F-mount (C15550-22UP01) is also available. If you wish, please contact your local Hamamatsu representative or distributor. F-mount has a light leakage due to its structure and it might affect your measurements especially with longer exposure time.

# System Configuration

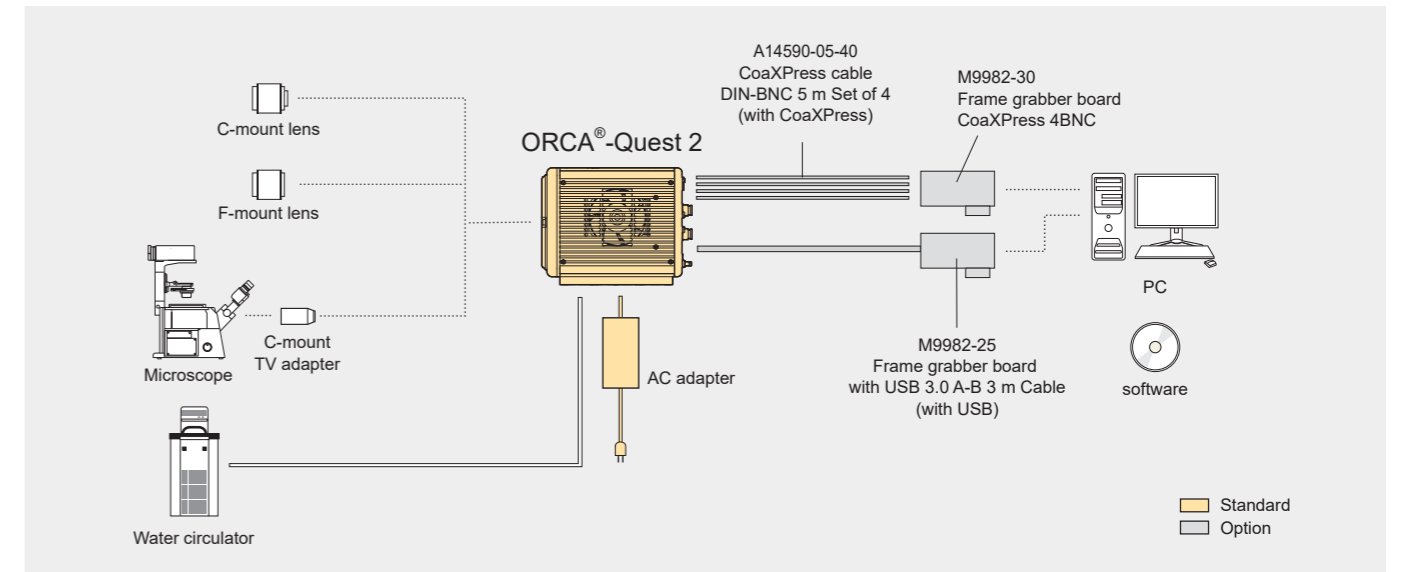

# Software and Interface

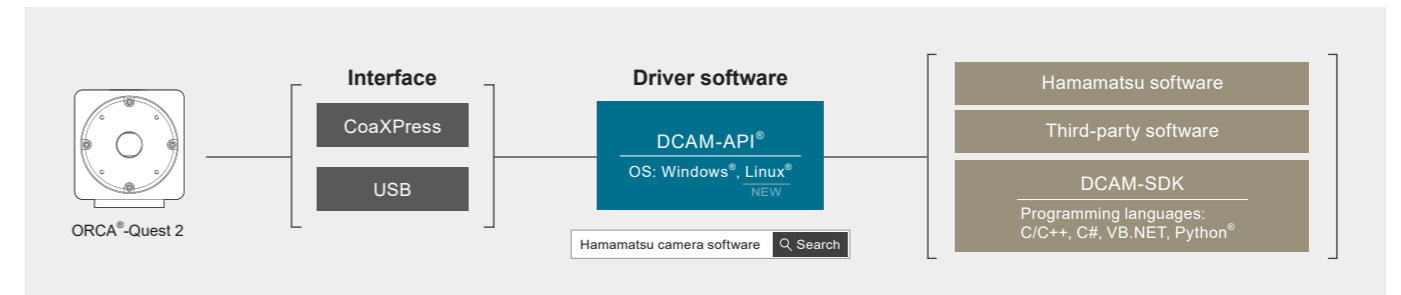

# Option

Product number	Product name
M9982-30	Frame grabber board CoaXPress 4BNC
A14590-05-40	CoaXPress cable DIN-BNC 5 m Set of 4
A14590-10-40	CoaXPress cable DIN-BNC 10 m Set of 4
M9982-25	Frame grabber board with USB 3.0 A-B 3 m Cable
A12106-05	External trigger cable SMA-BNC 5 m
A12107-05	External trigger cable SMA-SMA 5 m

# Dimensional Outlines (Unit: mm)

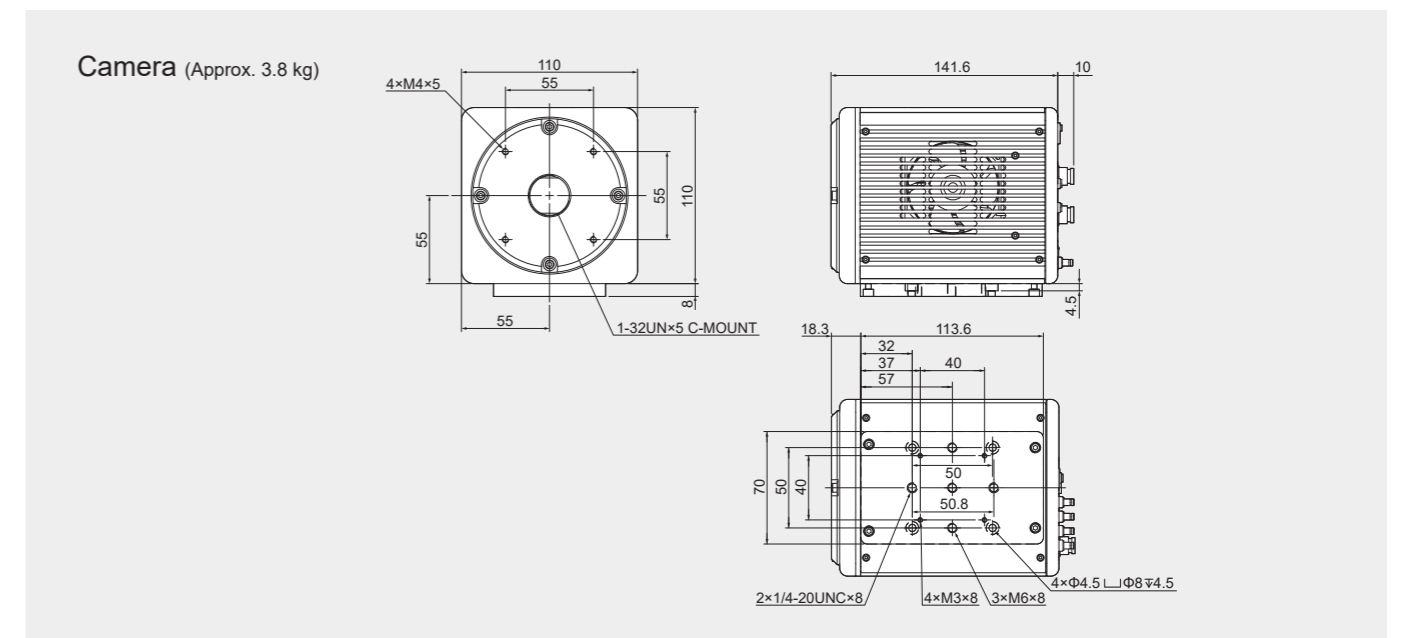

# HAMAMATSU

PHOTON IS OUR BUSINESS

- ORCA and qCMOS are registered trademarks of Hamamatsu Photonics K.K. (China, EU, Japan, UK, USA).
- DCAM-API is registered trademark of Hamamatsu Photonics K.K. (EU, Japan, UK, USA).
- Windows is a registered trademark of Microsoft Corporation in the USA (and other countries).
- Linux is a registered trademark of Linus Torvalds in the USA (and other countries).
- Python is a registered trademark of the Python Software Foundation.
- The product and software package names noted in this brochure are trademarks or registered trademarks of their respective manufacturers.
- Subject to local technical requirements and regulations, availability of products included in this brochure may vary. Please consult your local sales representative.
- The product described in this brochure is designed to meet the written specifications, when used strictly in accordance with all instructions.
- The spectral response specified in this brochure is typical value and not guaranteed.
- The measurement examples in this brochure are not guaranteed.
- Specifications and external appearance are subject to change without notice.

© 2024 Hamamatsu Photonics K.K.

## HAMAMATSU PHOTONICS K.K. [www.hamamatsu.com](http://www.hamamatsu.com)

### Systems Division

812 Joko-cho, Chuo-ku, Hamamatsu City, 431-3196, Japan, Telephone: (81)53-431-0124, Fax: (81)53-433-8031, E-mail: [export@sys.hpk.co.jp](mailto:export@sys.hpk.co.jp)

U.S.A.: HAMAMATSU CORPORATION: 360 Foothill Road, Bridgewater, NJ 08807, U.S.A., Telephone: (1)908-231-0960, Fax: (1)908-231-1218

Germany: HAMAMATSU PHOTONICS DEUTSCHLAND GMBH: Arzbergerstr. 10, 82211 Herrsching am Ammersee, Germany, Telephone: (49)8152-375-0, Fax: (49)8152-265-8 E-mail: [info@hamamatsu.de](mailto:info@hamamatsu.de)

France: HAMAMATSU PHOTONICS FRANCE S.A.R.L.: 19 Rue du Saule Trapu, Parc du Moulin de Massy, 91882 Massy Cedex, France, Telephone: (33)1 69 53 71 00, Fax: (33)1 69 53 71 10 E-mail: [infos@hamamatsu.fr](mailto:infos@hamamatsu.fr)

United Kingdom: HAMAMATSU PHOTONICS UK LIMITED: 2 Howard Court, 10 Tewin Road, Welwyn Garden City, Hertfordshire, AL7 1BW, UK, Telephone: (44)1707-294888, Fax: (44)1707-325777 E-mail: [info@hamamatsu.co.uk](mailto:info@hamamatsu.co.uk)

North Europe: HAMAMATSU PHOTONICS NORDEN AB: Torshamnsgatan 35 16440 Kista, Sweden, Telephone: (46)8-509 031 00, Fax: (46)8-509 031 01 E-mail: [info@hamamatsu.se](mailto:info@hamamatsu.se)

Italy: HAMAMATSU PHOTONICS ITALIA S.R.L.: Strada della Moia, 1 int. 6, 20044 Arese (Milano), Italy, Telephone: (39)02-93 58 17 33, Fax: (39)02-93 58 17 41 E-mail: [info@hamamatsu.it](mailto:info@hamamatsu.it)

China: HAMAMATSU PHOTONICS (CHINA) CO., LTD.: 1201 Tower B, Jiaming Center, 27 Dongsanhuan Bellu, Chaoyang District, 100020 Beijing, P.R. China, Telephone: (86)10-6586-6006, Fax: (86)10-6586-2866 E-mail: [hpc@hamamatsu.com.cn](mailto:hpc@hamamatsu.com.cn)

Taiwan: HAMAMATSU PHOTONICS TAIWAN CO., LTD.: 13F-1, No.101, Section 2, Gongdao 5th Road, East Dist., Hsinchu City, 300046, Taiwan(R.O.C), Telephone: (886)3-659-0080, Fax: (886)3-659-0081 E-mail: [info@hamamatsu.com.tw](mailto:info@hamamatsu.com.tw)

Cat. No. SCAS0166E01  
MAR/2024 HPK  
Created in Japan