

pco.panda 4.2

ultra compact **sCMOS** camera

lightsheet
scanning mode

up to 80 %
quantum efficiency

available in
mono and color

USB 3.1
interface

resolution
2048 x 2048 pixels
with 6.5 μm pixel size



65 mm

**ultra
compact
design**

single cable solution
data & power supply via USB 3.1

pco.

An Excelitas Technologies Brand

» sCMOS image sensor

type of sensor	scientific CMOS (sCMOS) monochrome or color (bayer pattern)
resolution (h x v)	2048 x 2048 active pixels
pixel size (h x v)	6.5 µm x 6.5 µm
sensor format / diagonal	13.3 mm x 13.3 mm / 18.8 mm
shutter mode	rolling shutter (RS) additional feature: lightsheet scanning mode¹
MTF	76.9 lp/mm (theoretical)
fullwell capacity	45,000 e ⁻
readout noise (typ.)²	2.1 med e ⁻ / 2.3 rms e ⁻
dynamic range (typ.)	21400 : 1 87 dB
quantum efficiency	up to 80 % (monochrome)
spectral range	370 nm ... 1100 nm
dark current (typ.)	15 e ⁻ /pixel/s @ 21 °C ambient temperature
DSNU	0.5 rms e ⁻
PRNU	0.6 %
anti blooming factor³	> 10 000

¹ Selectable via SDK (software development kit).

² The readout noise values are given as median (med) and root mean square (rms) values, due to the different noise models, which can be used for evaluation. All values are raw data without any filtering.

³ Based on image sensor datasheet.

lightsheet scanning mode

The PCO lightsheet scanning mode is a special readout mode dedicated to lightsheet microscopy. It is based on the rolling shutter mode in which the readout direction of the sensor is from top to bottom.

The standard line time value is 12 µs and it can be set from this camera-specific line time up to 2 ms. Compared to the standard operation mode, the lightsheet scanning mode enables the selection of the parameters "Line Time" and "Exposure Lines". This guarantees an optimized synchronization to an existing lightsheet setup which has no selectable speed or timing. It is possible to set a delay prior to the exposure start ("delay lines").

For more information on the corresponding SDK functions, please read our pco.sdk instruction manual.

selectable parameter: **T_L Line Time** (12 µs ... 2 ms) **Start Exposure**
(only via SDK) **L_E Exposure Lines** (1 ... 2048) **End Exposure**

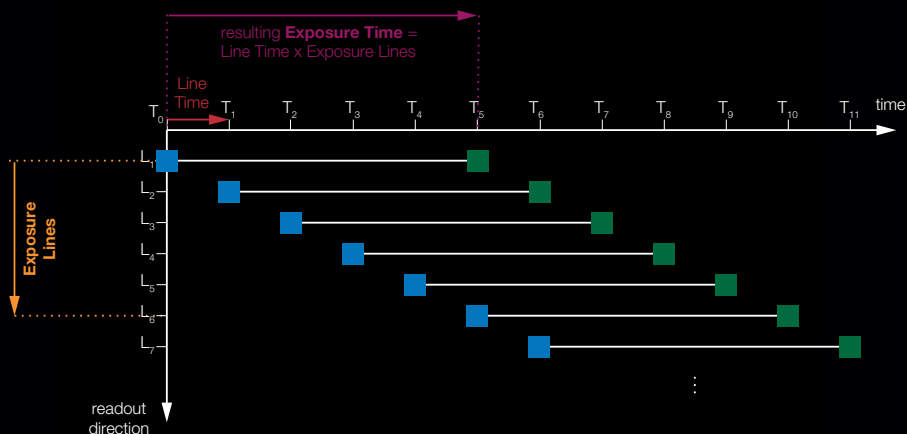

» camera system

maximum frame rate @ full resolution	40 fps
exposure / shutter time	21 μ s .. 5 s
dynamic range A/D⁴	16 bit
A/D conversion factor	0.65 e ⁻ /DN
pixel scan rate	44.0 MHz
pixel data rate	176.0 Mpixel/s
binning horizontal	x1, x2, x4
binning vertical	x1, x2, x4
region of interest (ROI)	horizontal: steps of 32 pixels vertical: steps of 8 pixels
non linearity	< 0.6 %
cooling method	passive cooled
trigger input signals	frame trigger, acquire (SMA connectors)
trigger output signals	exposure, busy (SMA connectors)
data interface	USB 3.1 Gen 1
time stamp	in image (1 μ s resolution)

⁴ The high dynamic signal is simultaneously converted at high and low gain by two 12 bit A/D converters and the two 12 bit values are sophisticatedly merged into one 16 bit value.

» general

power delivery	power over USB 3.1 Gen 1
power consumption	typ. 4.5 W (max. 6.0 W)
weight	420 g
operating temperature	+ 10 °C ... + 40 °C
operating humidity range	10 % .. 80 % (non-condensing)
storage temperature range	- 10 °C .. + 60 °C
optical interface	C-mount (optional: F-mount)
maximum cable length	5 m
CE / FCC certified	yes

» frame rate table

2048 x 2048	40 fps
2048 x 1024	80 fps
2048 x 512	161 fps
2048 x 256	303 fps
2048 x 128	528 fps
1920 x 1080	76 fps
1600 x 1200	69 fps
1280 x 1024	80 fps
640 x 480	171 fps
320 x 240	321 fps

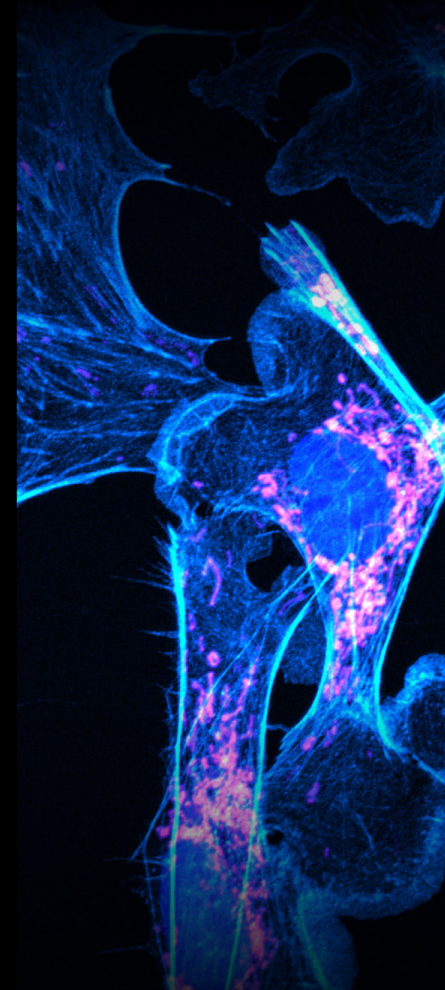
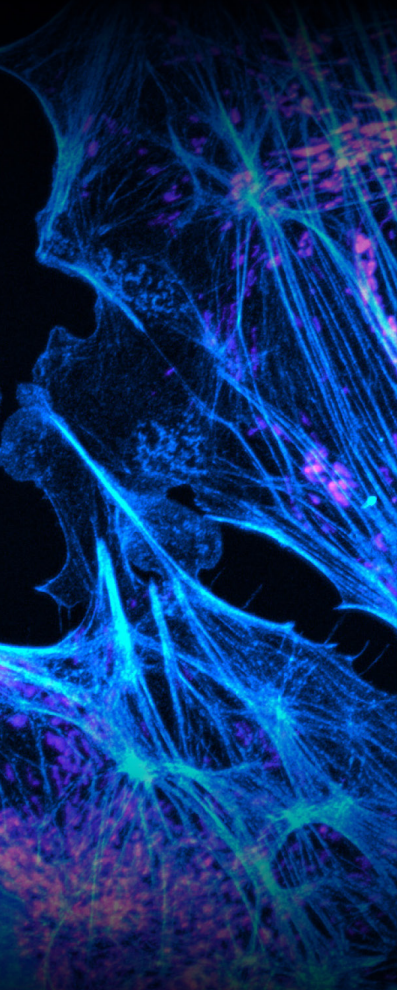

» quantum efficiency

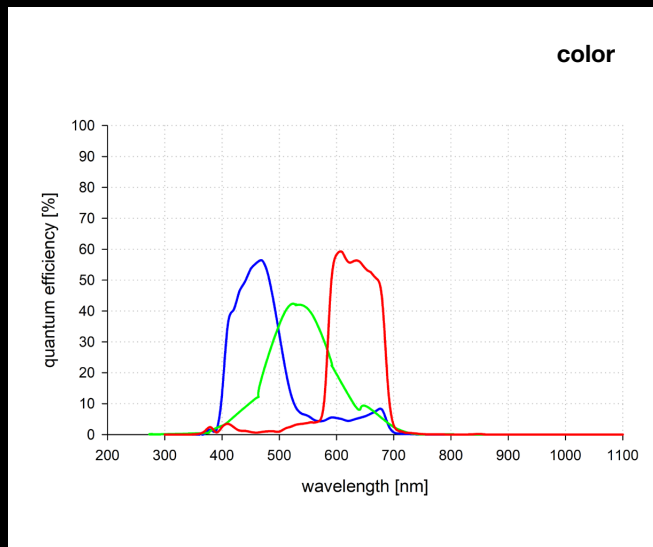
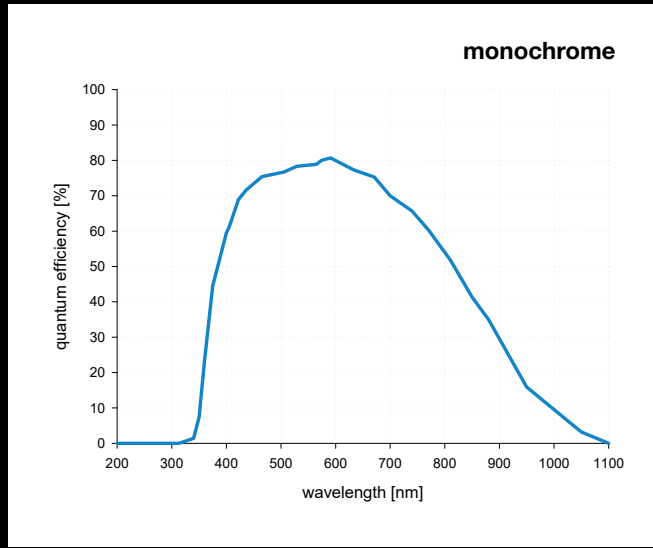
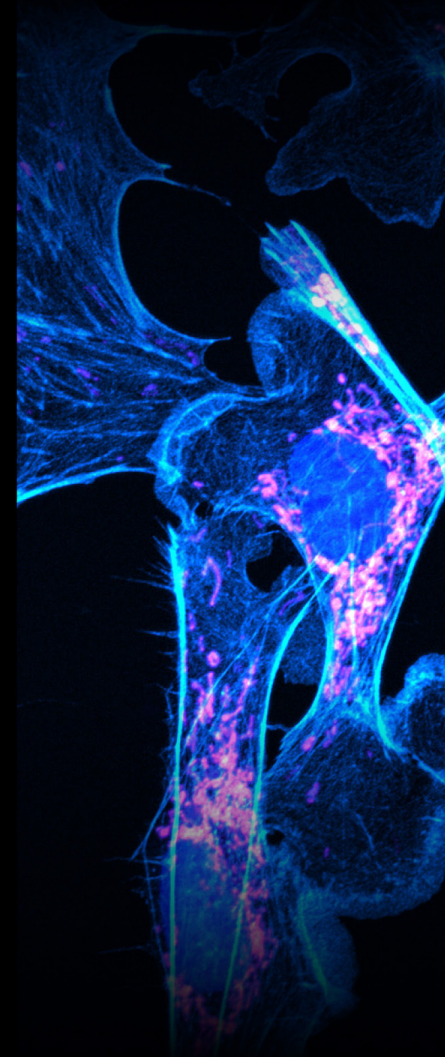
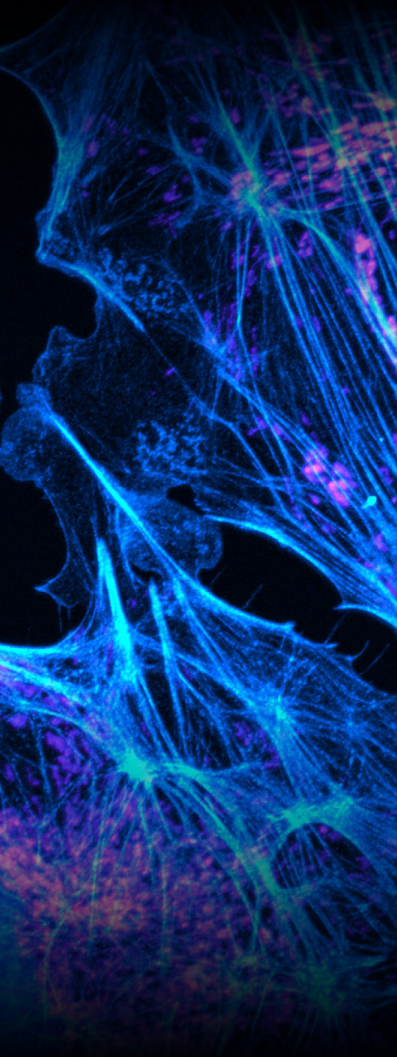

» dimensions

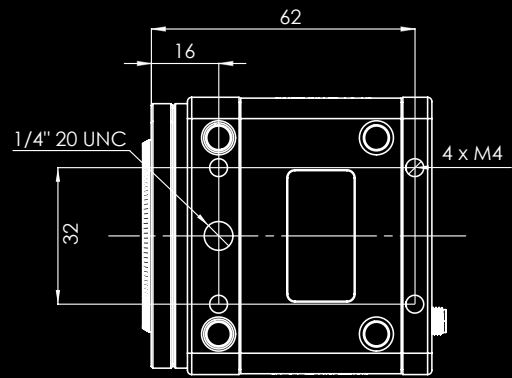
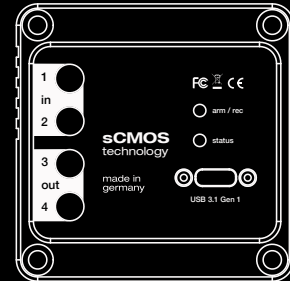
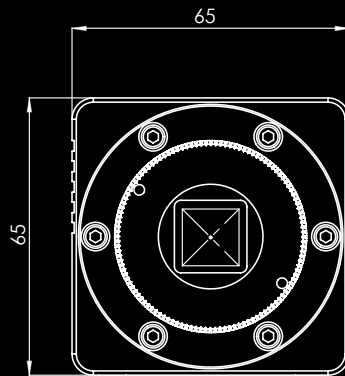
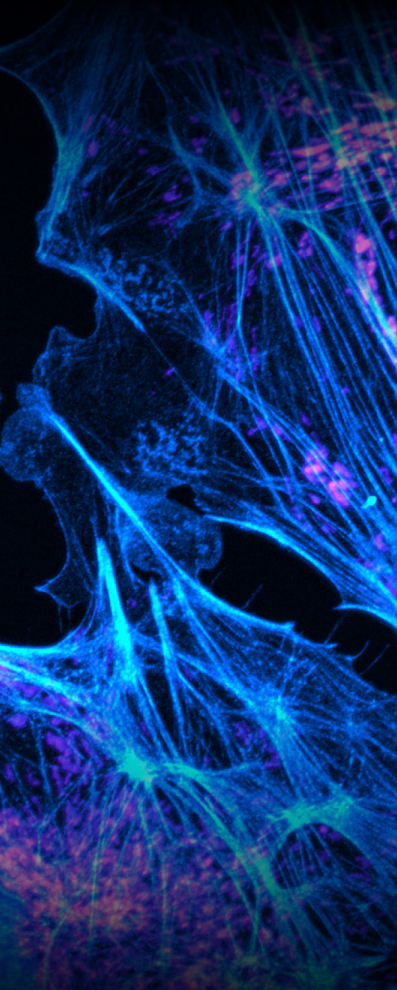

F-mount and C-mount lens adapter are changeable. All dimensions are given in millimeter.

» camera view

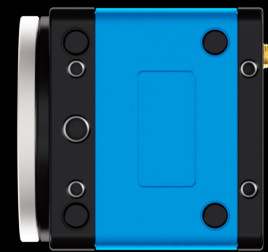
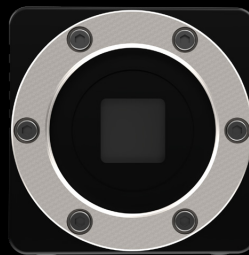

» applications

brightfield microscopy | fluorescence microscopy | digital pathology | single molecule localization microscopy | lightsheet fluorescence microscopy (LSFM) | calcium imaging | FRET | FRAP | structured illumination microscopy (SIM) | high-speed bright field ratio imaging | high-throughput screening | high-content screening | biochip reading | TIRF microscopy | spinning disk confocal microscopy | ophthalmology | industrial quality inspection

» software

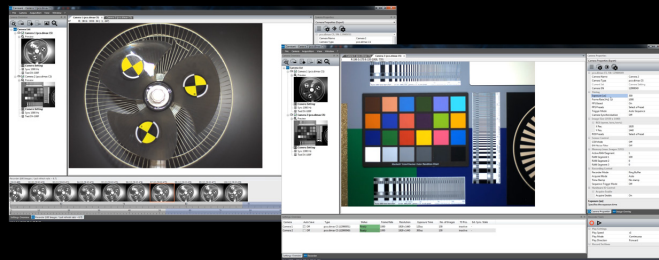

With pco.camware you control all camera settings, the image acquisition, and the storage of your image data. The pco.sdk is the complementary software development kit. It includes dynamic link libraries for user customization and integration on Windows PC platforms. Drivers for popular third party software packages are also available for you.

All these items like pco.camware, pco.sdk, and third party drivers are free-to-download at www.pco.de

» third party integrations



pcO.

An Excelitas Technologies Brand

telephone:

+ 49 (0) 9441 2005 50

fax:

+ 49 (0) 9441 2005 20

postal address:

Excelitas PCO GmbH

Donaupark 11

93309 Kelheim, Germany

email:

pcO@excelitas.com

web:

www.pcO.de

www.excelitas.com

