

Light Measurement



The Standard for over 50 Years

Introduction

LI-COR radiation sensors measure the flux of radiant energy—the energy that drives plant growth, warms the earth, and lights our world. The properties of radiant flux depend on the wavelength of the radiation. Pyranometers are sensitive to the broadest waveband. Photometric sensors measure visible radiation (light). Quantum sensors measure Photosynthetically Active Radiation (PAR)—the radiant energy used in photosynthesis. These three sensor types cover a wide range of applications:

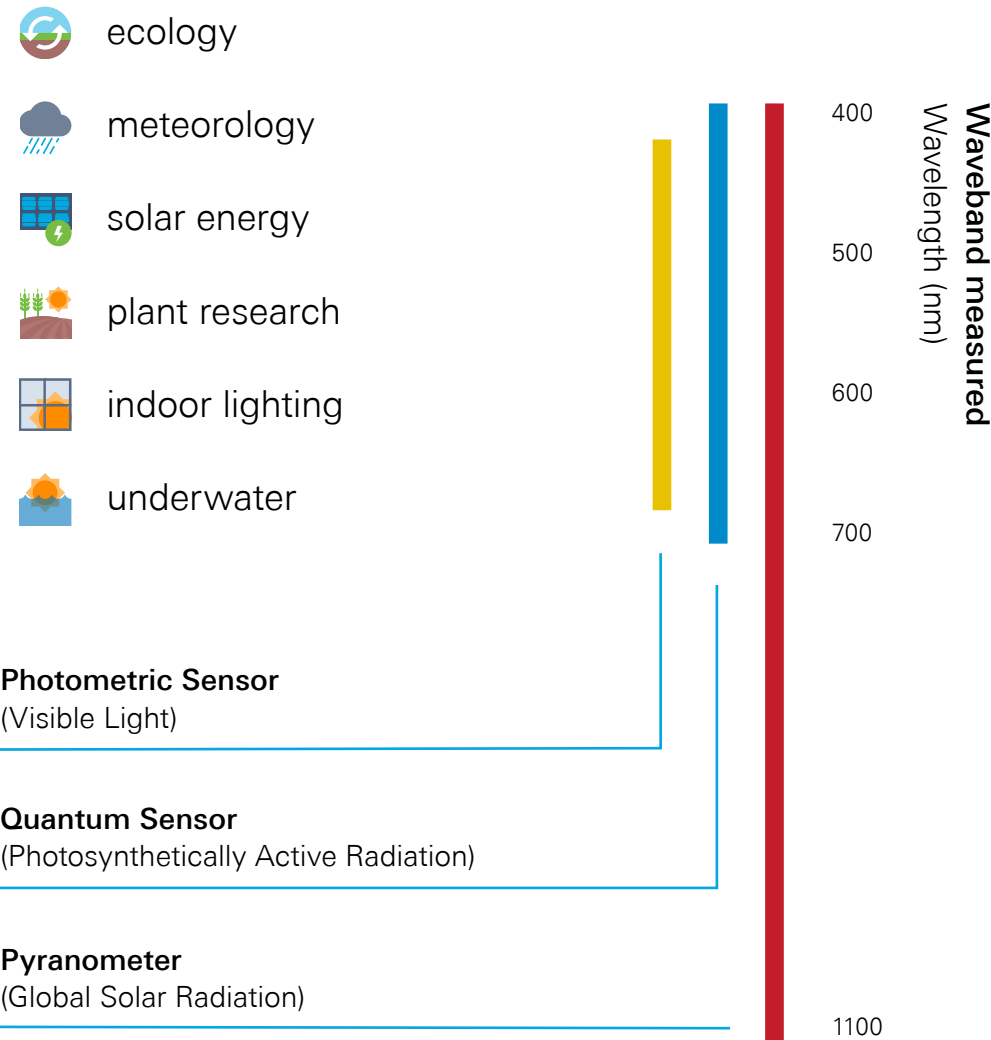

The Sensors

LI-COR sensors are weather resistant, low maintenance, and cosine corrected. From the shape of the crown to the photodiodes and optical filter glass, every aspect is the result of scientific inquiry.

The sensor design features a large drain to shed water, and a more robust housing to help prevent water ingress, increasing the lifespan of the sensors and reducing measurement drift. A detachable sensor head allows for replacement and factory recalibration without removing the cable from the mounting structure.

Water shedding design



Interchangeable heads

Detachable base

Multiple output signals

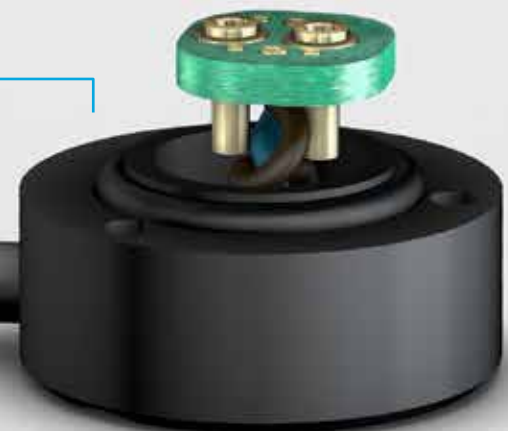

LI-200R Pyranometer

The LI-200R Pyranometer is meant to be used outdoors under unobstructed natural daylight conditions. It measures global solar radiation—the combination of direct and diffuse solar radiation—in the 400 to 1100 nm range. Measurement units are in watts per square meter ($W m^{-2}$).

Ideal for agricultural, meteorological, solar energy, and environmental research, the LI-200R is available with a variety of cable lengths and output signals for compatibility with most data loggers.



Why choose the LI-200R?

- Weather resistant and durable in long-term outdoor deployments
- Measures global solar radiation under unobstructed natural daylight conditions
- Uniform sensitivity up to 82° incident angle
- Detachable sensor simplifies installation and removal, making it ideal for platforms with complex cabling

How does it work?

The LI-200R measures global solar radiation with an unfiltered silicon photodiode. Its measurements correspond closely to first-class thermopiles when used outdoors under unobstructed natural daylight conditions.

The crown of the sensor rapidly sheds water, and also physically blocks light from outside the hemisphere of sensitivity, providing a precise cosine response.

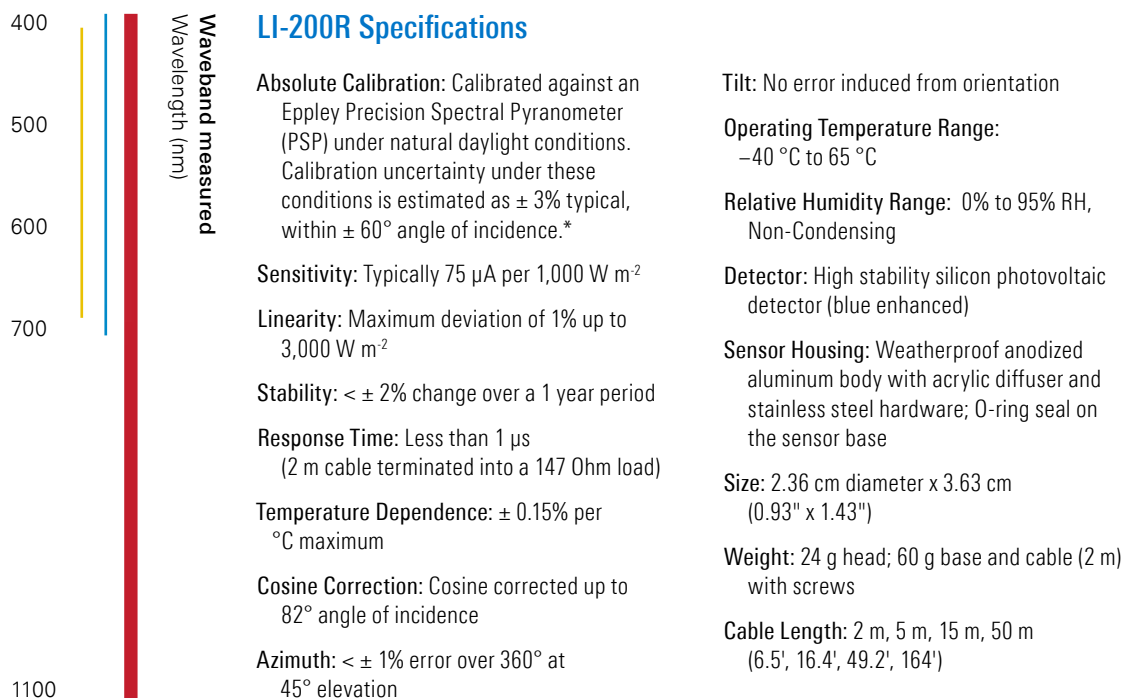

Specifications subject to change without notice.

*Preliminary specification

LI-190R Quantum Sensor



The LI-190R measures Photosynthetically Active Radiation (PAR, in μmol of photons $\text{m}^{-2} \text{s}^{-1}$). It provides accurate measurements—in the open, in greenhouses, under plant canopies, or in growth chambers—for most broad-spectrum light sources, including natural sunlight, artificial, or mixed sources.

Plants use light in the wavelength range from about 400 to 700 nm to drive photosynthesis. The efficiency with which plants use light varies somewhat across this range, but McCree¹ showed that measuring PAR provided a consistent way to predict plant photosynthetic response regardless of the spectrum of the light source.²

1. McCree, K.J., 1972. The action spectrum, absorbance and quantum yield of photosynthesis in crop plants. *Agric. Meteorol.* 9: 191-216.

2. McCree, K.J., 1972. Test of current definitions of photosynthetically active radiation against leaf photosynthesis data. *Agric. Meteorol.* 10: 443-453.

Why choose the LI-190R?

- Uniform sensitivity across the PAR waveband for accurate measurements outdoors, under vegetation, or in artificial lighting without changing the calibration
- Newly designed optical filter tailors the spectral response to an unprecedented performance standard
- Weather resistant and durable in high-temperature, high-humidity, long-term deployments
- Cosine correction is accurate even when the light source is not directly overhead
- Sensor heads are detachable and interchangeable for simplified installation, removal, and recalibration

How does it work?

A high-quality silicon photodiode is matched with a specially designed glass optical filter to create nearly uniform sensitivity to all the wavelengths within the PAR waveband (400 to 700 nm). This ensures accurate measurements irrespective of the light source. The glass filter excludes light with wavelengths outside the PAR waveband. Exclusion of wavelengths beyond 700 nm is critical for measurements under vegetation.

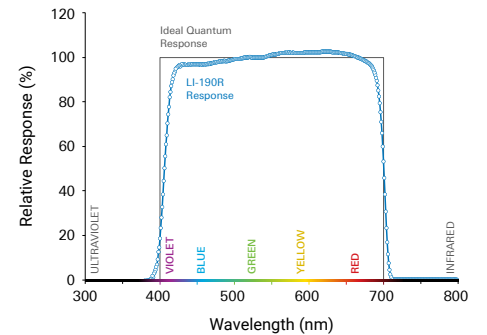
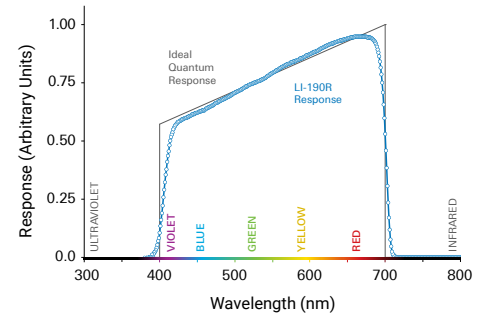

The LI-190R quantum response and the ideal quantum response curve in energy units (top) and photon units (bottom).

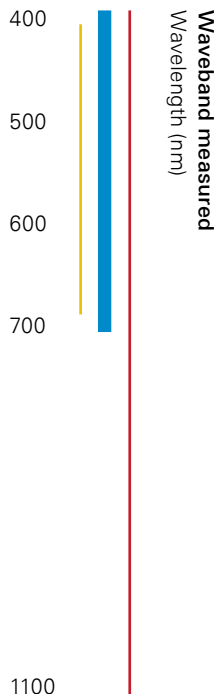

LI-190R Specifications

Absolute Calibration: $\pm 5\%$ traceable to the U.S. National Institute of Standards and Technology (NIST)

Sensitivity: Typically $5 \mu\text{A}$ to $10 \mu\text{A}$ per $1,000 \mu\text{mol s}^{-1} \text{m}^{-2}$

Linearity: Maximum deviation of 1% up to $10,000 \mu\text{mol s}^{-1} \text{m}^{-2}$

Stability: $< \pm 2\%$ change over a 1 year period

Response Time: Less than $1 \mu\text{s}$ (2 m cable terminated into a 604 Ohm load)

Temperature Dependence: $\pm 0.15\%$ per $^{\circ}\text{C}$ maximum

Cosine Correction: Cosine corrected up to 82° angle of incidence

Azimuth: $< \pm 1\%$ error over 360° at a 45° elevation

Tilt: No error induced from orientation

Operating Temperature Range: -40°C to 65°C

Relative Humidity Range: 0% to 95% RH, Non-Condensing

Detector: High stability silicon photovoltaic detector (blue enhanced)

Sensor Housing: Weatherproof anodized aluminum body with acrylic diffuser and stainless steel hardware; O-ring seal on the sensor base

Size: 2.36 cm diameter x 3.63 cm (0.93" x 1.43")

Weight: 24 g head; 60 g base and cable (2 m) with screws

Cable Length: 2 m, 5 m, 15 m, 50 m (6.5', 16.4', 49.2', 164')

Specifications subject to change without notice.

LI-210R Photometric Sensor

The LI-210R Photometric Sensor measures light with the same sensitivity as a typical human eye. The photometric sensor is ideal for evaluating illumination in work areas, exhibits, interior lighting, and in public spaces. Measurement units are lux or klux.



Why choose the LI-210R?

- Spectral response closely matches the CIE Standard Observer Curve
- Excellent cosine response—sensitive to light from all directions up to an 82° angle of incidence
- Detachable sensor simplifies installation and removal, making it ideal for platforms with complex cabling

How does it work?

The LI-210R measures light with a precision filtered silicon photodiode that is sensitive to light in the visible spectrum.

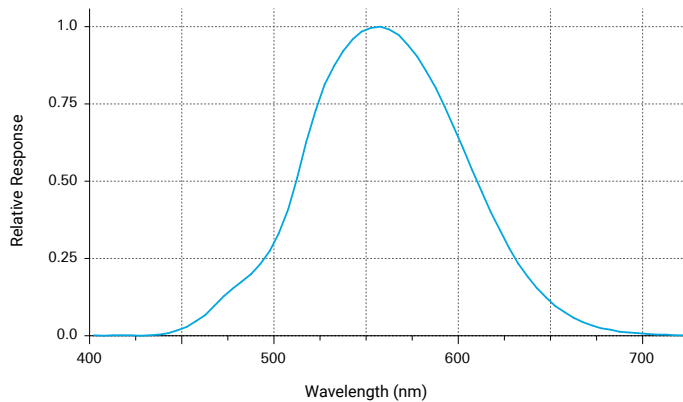

Typical spectral response of the LI-210R Photometric Sensor.

400
500
600
700
1100

Waveband measured
Wavelength (nm)

LI-210R Specifications

Absolute Calibration: $\pm 5\%$ traceable to the U.S. National Institute of Standards and Technology (NIST)

Sensitivity: Typically 30 μA per 100 klux

Linearity: Maximum deviation of 1% up to 100 klux

Stability: $< \pm 2\%$ change over a 1 year period

Response Time: Less than 1 μs (2 m cable terminated into a 604 Ohm load)

Temperature Dependence: $\pm 0.15\%$ per $^{\circ}\text{C}$ maximum

Cosine Correction: Cosine corrected up to 82° angle of incidence

Azimuth: $< \pm 1\%$ error over 360° at 45° elevation

Tilt: No error induced from orientation

Operating Temperature Range: -40°C to 65°C

Relative Humidity Range: 0% to 95% RH, Non-Condensing

Detector: High stability silicon photovoltaic detector (blue enhanced)

Sensor Housing: Weatherproof anodized aluminum housing with acrylic diffuser and stainless steel hardware; O-ring seal on the sensor base

Size: 2.36 cm diameter x 3.63 cm (0.93" x 1.43")

Weight: 24 g head; 60 g base and cable (2 m) with screws

Cable Length: 2 m, 5 m, 15 m, 50 m (6.5', 16.4', 49.2', 164')

Specifications subject to change without notice.

A person wearing a plaid shirt is holding a long, silver, rectangular LI-191R Line Quantum Sensor. The sensor is held horizontally, extending from the left side of the frame towards the right. The background is a blurred green field. In the lower-left corner, a portion of a black electronic device with a keypad and a small screen is visible.

LI-191R Line Quantum Sensor

The LI-191R Line Quantum Sensor measures PAR integrated over its 1-meter length. It is used to measure sunlight under a plant canopy, where the light field is non-uniform. The LI-191R makes it easy to measure under-canopy light in many plots quickly and consistently. It measures light in units of Photosynthetic Photon Flux Density (PPFD), which is expressed as $\mu\text{mol s}^{-1} \text{m}^{-2}$.

Why choose the LI-191R?

- Improved water resistance for long-term outdoor deployment
- Integrated measurements using a single detector prevents variance found in sensors that use multiple detectors
- Selected by the National Ecological Observatory Network (NEON®) for integrated PAR measurements

How does it work?

The LI-191R uses a 1-meter long quartz rod under a diffuser to direct light to a single filtered silicon photodiode. The entire LI-191R diffuser is sensitive to light over its 1-meter length. Since the diffuser is one continuous piece, the LI-191R essentially integrates an infinite number of points over its surface into a single value that represents light from the entire 1-meter length. Optical filters block radiation with wavelengths beyond 700 nm, which is critical for under-canopy measurements, where the ratio of infrared to visible light may be high. The unique design of the LI-191R provides an excellent quantum response that is close to the ideal quantum response.

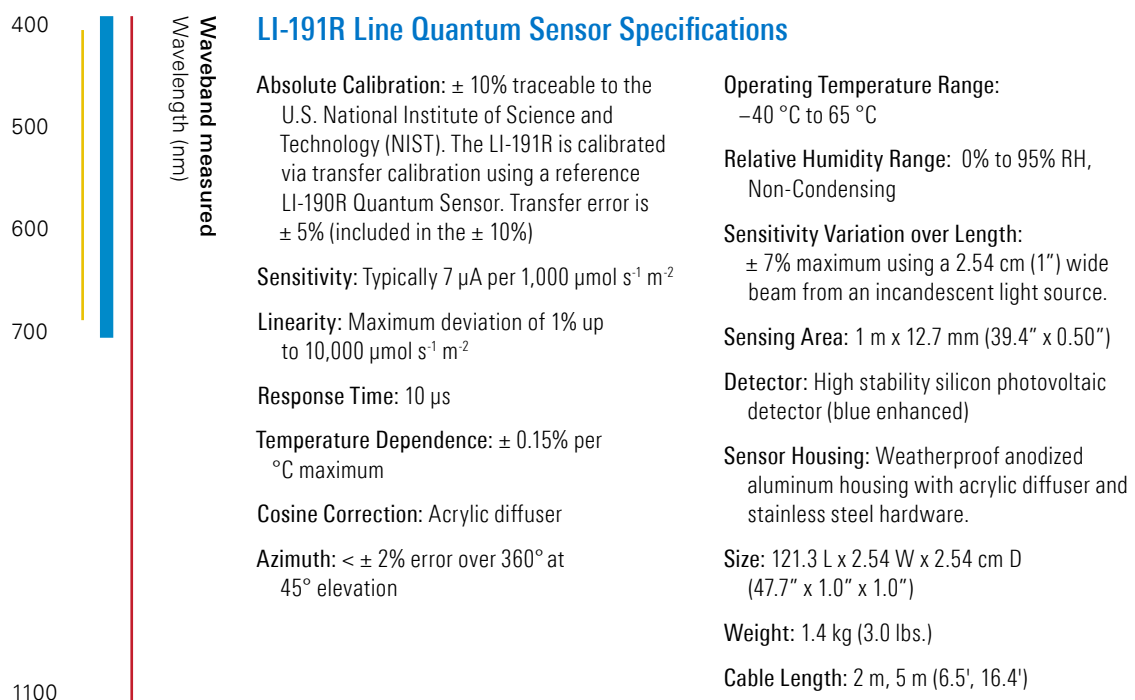

Specifications subject to change without notice.

LI-192 Underwater Quantum Sensor

The LI-192 Underwater Quantum Sensor measures PAR from all angles in one hemisphere. The LI-192 works in air or underwater at depths up to 560 meters. The measurements are cosine corrected and typically expressed as Photosynthetic Photon Flux Density (PPFD). For simultaneous measurements of downwelling and upwelling PAR, two sensors can be mounted on the 2009S Lowering Frame.



Why choose the LI-192?

- Designed for immersion
- Rugged, corrosion-resistant sensors for use in fresh and saltwater environments
- Ideal for oceanography, limnology, turbidity, and vertical profiling
- Suitable for submerged and out-of-water measurements

How does it work?

The LI-192 uses a silicon photodiode and a glass optical filter to create nearly uniform sensitivity to light between 400 and 700 nm, which closely corresponds to light used by most terrestrial and aquatic plants and algae. A precision optical filter blocks light with wavelengths beyond 700 nm, which is critical for measurements in a water column, where the ratio of infrared to visible light may be high.

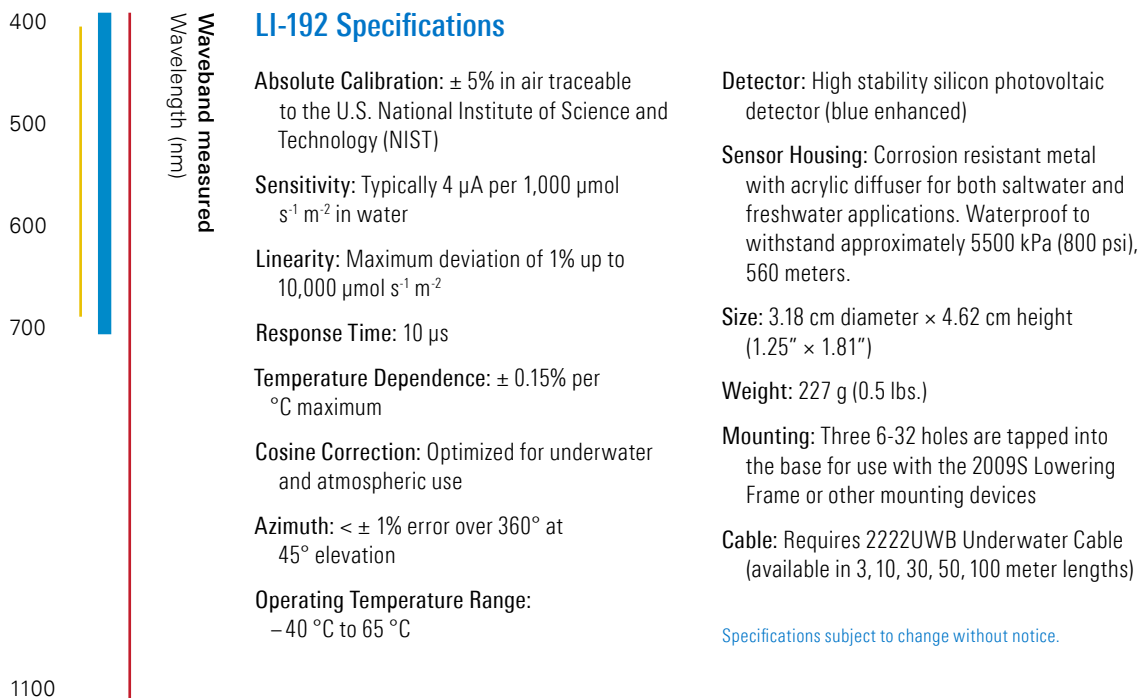

LI-193 Spherical Quantum Sensor

The LI-193 Spherical Quantum Sensor measures PAR in air or underwater from all directions at depths up to 350 meters. This sensor is useful for studies of phytoplankton, which uses radiation from all directions. The measurement is referred to as Photosynthetic Photon Flux Fluence Rate (PPFFR) or Quantum Scalar Irradiance.



Why choose the LI-193?

- Designed for immersion
- Measures PAR from all directions
- Ideal for oceanography, limnology, turbidity, and vertical profiling

How does it work?

The LI-193 uses a diffusive sphere to direct light through glass optical filters to the silicon photodiode. The filters create nearly uniform sensitivity to light between 400 and 700 nm, which closely corresponds to light used by most terrestrial and aquatic plants and algae. The angular response of a typical LI-193 is slightly lower in the direction of the cable connection. When mounted, the low response is usually not significant due to the small proportion of upwelling radiation compared to the total.

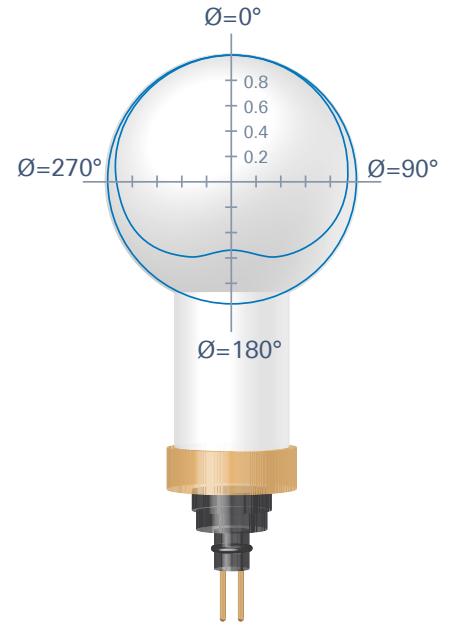

Typical angular response of the LI-193.

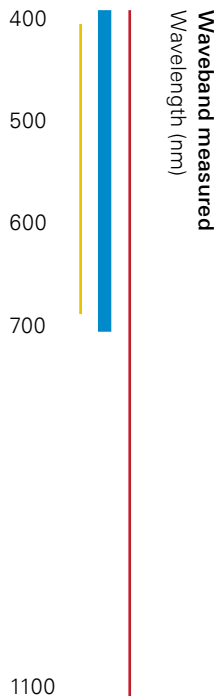

LI-193 Specifications

Absolute Calibration: $\pm 5\%$ in air traceable to the U.S. National Institute of Science and Technology (NIST)

Sensitivity: Typically $7 \mu\text{A}$ per $1,000 \mu\text{mol s}^{-1} \text{m}^{-2}$ in water

Linearity: Maximum deviation of 1% up to $10,000 \mu\text{mol s}^{-1} \text{m}^{-2}$

Stability: $< \pm 2\%$ change over a 1 year period

Response Time: $10 \mu\text{s}$

Temperature Dependence: $\pm 0.15\%$ per $^{\circ}\text{C}$ maximum

Angular Response: $< \pm 4\%$ error up to $\pm 90^{\circ}$ from normal axis (see Angular Response chart)

Azimuth: $< \pm 3\%$ error over 360° at 90° from normal axis

Operating Temperature Range: -40°C to 65°C

Sensor Housing: Corrosion resistant metal for both saltwater and freshwater applications with an injection molded, impact resistant, acrylic diffuser. Units have been tested to $3,400 \text{ kPa}$ (500 psi), 350 meters.

Detector: High stability silicon photovoltaic detector (blue enhanced)

Size:

- Globe: 6.1 cm diameter ($2.4''$)
- Housing: 3.18 cm diameter ($1.25''$)
- Overall Height: 10.7 cm ($4.2''$)

Weight: 142 g (0.31 lbs.)

Mounting: Three 6-32 mounting holes are tapped into the base for use with the 2009S Lowering Frame or other mounting devices.

Cable: Requires 2222UWB Underwater Cable (available in $3, 10, 30, 50, 100$ meter lengths)

Specifications subject to change without notice.

LI-1500 Light Sensor Logger

The LI-1500 Light Sensor Logger provides a direct digital readout and data logging from up to three LI-COR sensors at the same time. Log manually or set up single, daily, or continual logging routines. Take advantage of the intuitive, menu-driven interface, optional GPS system, high frequency measurements up to 500 Hz, and built-in math functions.



Why choose the LI-1500?

- Large 1-GB memory for storing data and up to 100 sensor-specific multipliers
- Rugged, weather-resistant housing and optional GPS for outdoor use or transect measurements
- Eight math functions, including integration, natural logarithm, and underwater attenuation

LI-1500 Specifications

Current Inputs: 3 BNC connectors for LI-COR sensors

Output Channels:

- Light
- 8 Math Channels: addition, subtraction, multiplication, division, natural logarithm, integration, daily integration, attenuation
- GPS (optional)
- Prompt
- Battery Voltage

Frequency Rejection: >70dB at 50 or 60 Hz (1 input channel @ sampling rates of 1, 2, 5, 10, 20Hz)

Current Accuracy: $\pm 0.3\%$ of full scale reading @ 25 °C

Signal Ranges:

Range	Current Range	Resolution
1	0 – 0.250 μ A	0.0305 nA
2	0 – 2.50 μ A	0.1525 nA
3	0 - 25 μ A	1.525 nA
4	0 - 250 μ A	15.25 nA

Standard Modes (Continual, Manual, Daily, One Time):

- Auto range for total sampling rate ≤ 3 Hz (e.g. 1 Hz sampling on three input channels)
- Fixed range (selectable) for total sampling rates > 3 Hz (e.g. 2 Hz sampling on two input channels)

Standard Modes Sampling:

- 0.01 Hz, 0.1 Hz, 1 Hz, 2 Hz, 5 Hz, 10 Hz, 20 Hz
- Every Sample, 100 msec, 200 msec, 500 msec, 1 sec, 5 sec, 10 sec, 15 sec, 30 sec, 60 sec, 100 sec, 5 min, 15 min, 30 min, 1 hr, 2 hr, 3 hr, 6 hr, 12 hr, 24 hr

Raw Mode (1 – 500 Hz): Selectable Range (1 Hz through 500 Hz in whole number increments)

Raw Mode Sampling: Every sample (1 – 500 Hz)

Operating Temperature Range: -20 to 50°C

Humidity Range: 0 to 95% RH (non-condensing conditions)

Storage Temperature Range: -40 to 65°C

Averaging: Multiple averaging windows available with standard mode sampling

Display: 128 x 64 graphics display

Real-Time Clock:

- Year, Month, Day, Hour, Minute, Seconds
- Accuracy of ± 3 minutes per month

Data Storage Capacity: 1 GB (FAT16 file system)

Communications: USB (as mass storage device)

Global Positioning System (Option):
GPS RADIONOVA® RF Antenna Module

Power Supply Options:

- 4 "AA" size batteries
- USB, AC-DC power adapter
- USB, external battery power pack (customer supplied)

Battery Life:

- 80 hours life (typical usage with 1 Hz sampling and logging rate)
- 40 hours life (typical usage with GPS option on)

Size: 20.9 x 9.8 x 3.5 cm (8.2" x 3.9" x 1.4")

Weight: 0.454 kg (1.0 lb) with batteries

Specifications subject to change without notice.

LI-250A Light Meter

The LI-250A Light Meter provides a direct digital readout for any LI-COR radiation sensor equipped with a BNC connector. It displays instantaneous sensor output or 15-second averages, along with measurement units for any LI-COR sensor ($\mu\text{mol s}^{-1} \text{m}^{-2}$, lux, klux, or W m^{-2}).



Why choose the LI-250A?

- Retains two sensor multipliers in memory to aid in switching between sensors, or for storing in-air and in-water multipliers when used with underwater sensors
- Automatic range selection for the best accuracy and resolution in a wide variety of light environments
- Uses a high-gain amplifier for long-term stability, automatic zeroing, and low input impedance, resulting in excellent linearity

LI-250A Light Meter Specifications

Accuracy:

- 25 °C: Typically $\pm 0.4\%$ of reading ± 3 counts on the least significant digit displayed (all ranges).
- 0 - 55 °C: Typically $\pm 0.6\%$ of reading ± 3 counts on the least significant digit displayed (all ranges).

Range Selection: Autoranging (3 ranges).

Linearity: $\pm 0.05\%$.

LI-250A Range and Resolution:

Sensor	Range	Resolution
Quantum	0-199 $\mu\text{mol s}^{-1} \text{m}^{-2}$	0.01 $\mu\text{mol s}^{-1} \text{m}^{-2}$
	0-1999	0.1
	0-19999	1
Pyranometer	0-19 W m^{-2}	0.001 W m^{-2}
	0-199	0.01
	0-1999	0.1
Photometric	0-1999 lux	0.1 lux
	0-19999 lux	1 lux
	0-199 klux	0.01 klux

Sensors: Designed for LI-COR sensors with BNC-type connectors.

Sensor Calibration: Each sensor is supplied with a calibration multiplier. Calibration multipliers for two sensors can be stored in memory. Calibration multipliers are entered from the keypad.

Signal Averaging: Sensor output can be collected and displayed as a 15-second average (approximately 60 readings). Averages are retained on the display in HOLD mode.

Display: LCD display. Updated every 0.5 seconds in Instantaneous mode.

Battery Life: 150 hours typical with continuous operation.

Power Requirement: One 9V Alkaline battery.

Operating Conditions: 0 to 55 °C, 0 to 95% RH (non-condensing).

Storage Conditions: -55 to 60 °C, 0 to 95% RH (non-condensing).

Size: 14 × 7.7 × 3.8 cm (5.5" × 3" × 1.5").

Weight: 0.26 kg (0.57 lbs).

Specifications subject to change without notice

Science

LI-COR terrestrial light sensors are cosine-corrected, following Lambert's cosine law. A cosine-corrected sensor provides the most accurate measurements of radiation on a flat surface from all angles. Cosine correction ensures accurate measurements under various conditions such as low light levels and low solar elevation angles.

The design of the sensor creates the proper cosine response at angles of incidence up to 82° . Radiation is received by an acrylic disc called a diffuser, or "eye". When radiation strikes with a greater angle of incidence, more is received by the edge of the diffuser. This compensates for increasing reflection from the top surface as the angle of incidence grows larger. Beyond an angle of about 80° , the rim of the sensor begins to block some light in order to maintain the correct response as more radiation is received by the edge of the diffuser. At a 90° angle of incidence, the rim completely blocks the diffuser, in keeping with a proper cosine response.

LI-COR light sensors create the proper cosine response at various angles of incidence.

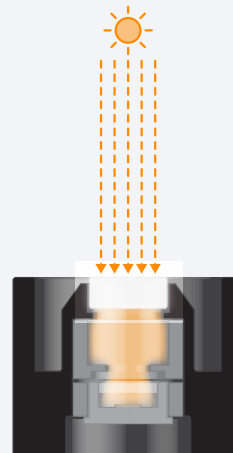

1. 0° : Light is received only by the top surface of the sensor eye.

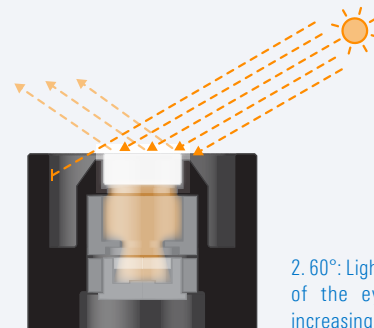

2. 60° : Light is received by the edge of the eye, compensating for increasing reflection from the top.

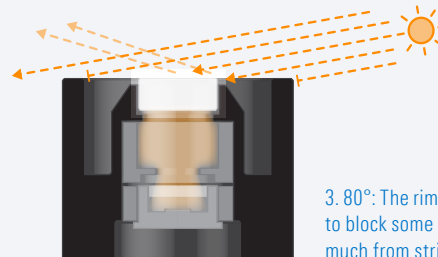

3. 80° : The rim of the sensor begins to block some light, preventing too much from striking the edge.

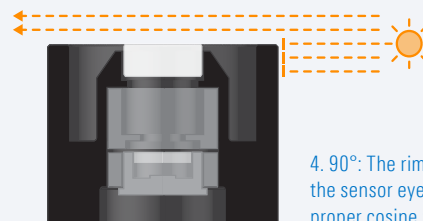

4. 90° : The rim completely blocks the sensor eye, in keeping with a proper cosine response.

LI-COR Calibration Standards

Calibration is an integral step in the manufacture of all LI-COR optical radiation-measuring instruments. Because of slight variation in internal optical components, it is necessary to characterize each individual sensor before it leaves LI-COR. This calibration data is supplied as a “calibration constant,” which indicates the amount of sensor output for a given amount of measurable energy input.

Calibration constants are used to convert the raw signal into the appropriate units of solar radiation. A readout device such as the LI-1500 Light Sensor Logger or LI-250A Light Meter can store calibration multipliers to do this conversion automatically. Other loggers and meters must have their data scaled by a factor determined from the calibration constant to derive the appropriate units.

The characteristics of the optical components may be affected by environmental conditions. We recommend recalibration every two years to ensure correct measurements.

Pyranometer Calibration

LI-200R Pyranometers are calibrated against an Eppley® Precision Spectral Pyranometer (PSP) under natural daylight conditions. Calibration uncertainty under these conditions is estimated as $\pm 3\%$ typical, within $\pm 60^\circ$ angle of incidence.*

Quantum Sensor Calibration

Quantum sensors, including the LI-190R, LI-191R, LI-192, and LI-193, are calibrated using working standard quartz halogen lamps, which have been calibrated against reference standard lamps traceable to the U.S. National Institute of Standards and Technology (NIST). The absolute calibration specification for quantum sensors is $\pm 5\%$ (typically $\pm 3\%$) traceable to NIST.

Photometric Sensor Calibration

The LI-210R photometric sensors are calibrated using 683 lumens per watt as a value of spectral luminous efficiency at a wavelength of 555 nm. This value conforms to the recommendations of the International Committee for Weights and Measures (CIPM). Calibration is performed using working standard quartz halogen lamps, which have been calibrated against reference standard lamps traceable to the NIST.

Specifications subject to change without notice.

*Preliminary specification

Ordering Information

Sensors

Terrestrial Sensors

Sensor: LI-190R Quantum Sensor, LI-200R Pyranometer, or LI-210R Photometric Sensor

Cable length: 2 m, 5 m, 15 m, or 50 m

Termination type: BNC, bare leads, millivolt adapter, or SMV (Standard Output Millivolt Adapter)

LI-191R Line Quantum Sensor

Each LI-191R includes a bubble level and carrying case.

Cable length: 2 m or 5 m

Termination type: BNC, Millivolt Adapter, or SMV (Standard Output Millivolt Adapter)

Underwater Quantum Sensors

Sensor: LI-192 Underwater Quantum Sensor or LI-193 Spherical Underwater Quantum Sensor

Cable length: 3 m, 10 m, 30 m, 50 m, or 100 m

Termination type: BNC or Millivolt Adapter

Logger and Meter

LI-1500 Light Sensor Logger

The LI-1500 connects up to three light sensors with BNC terminals. Includes four AA batteries, USB cable, AC power supply adapter, carabiner clip, carrying case, Windows® file viewer software. Sensors sold separately.

LI-1500G Light Sensor Logger with GPS

GPS-enabled.

LI-1500G-UW Light Sensor Logger with GPS – Underwater Package

GPS-enabled. Includes underwater lowering frame and carrying case for underwater light sensors, lowering frame, and cables.

LI-1500-UW Light Sensor Logger – Underwater Package

LI-1500 without GPS. Includes underwater lowering frame and carrying case for underwater light sensors, lowering frame, and cables.

LI-250A Light Meter

Connects to any light sensor with a BNC terminal and displays instantaneous or 15-second averaged measurements.

Accessories

1500GPS Upgrade Kit

User-installable upgrade adds GPS functionality to any LI-1500.

1500-01 Underwater Carrying Case

Case holds one LI-1500, underwater lowering frame, two LI-192 Underwater Quantum Sensors, two LI-193 Spherical Underwater Quantum Sensors, one terrestrial sensor (LI-190R, LI-200R, or LI-210R), and 3-meter or 10-meter underwater cable.

LI-250A Carrying Case

Fabric case for the LI-250A and one light sensor.

2001S Sensor Base Cover

Protects the base and cable when the sensor head is removed.

2003S Mounting and Leveling Fixture

For the LI-190R, LI-200R, and LI-210R Sensors. Anodized aluminum with stainless steel leveling screws and a weatherproof spirit level. 7.6 cm diameter (3.0") and 95 g (0.21 lbs.).

2009S Lowering Frame

Mounts one or two LI-192SA or LI-193SA sensors for lowering into water.

2420 Light Sensor Amplifier

Amplifies signal from light sensors. For use with logging devices that require an amplified voltage signal. Provides 15 gain settings to accommodate a wide variety of data loggers.

2420-BNC – For light sensors with BNC connectors.

2420-BL – For light sensors with bare leads.

Millivolt Adapters

Convert BNC connector to bare leads and the output signal to millivolts (mV). For use with logging devices that require a voltage signal. SMV-type adapters feature a standard output (0 to 10 mV) so that multipliers do not need to be changed when changing sensors. SMV-type adapters are factory adjusted to match a particular sensor's output. Provide the sensor's serial number when ordering.

2220 Millivolt Adapter – For the LI-200R Pyranometer.

2290 Millivolt Adapter – For the LI-190R Quantum Sensor, LI-210R Photometric Sensor, and LI-191R Line Quantum Sensor.

2291 Millivolt Adapter – For the LI-192SA and LI-193SA Underwater Sensors.

2320 (SMV) – For the LI-200R Pyranometer.

2319 (SMV) – For the LI-190R Quantum Sensor or LI-191R Line Quantum Sensor.

2321 (SMV) – For the LI-210R Photometric Sensor.

LI-COR Environmental

4647 Superior Street
Lincoln, Nebraska 68504

Phone: +1-402-467-3576
Toll free: 800-447-3576

envsales@licor.com
envsupport@licor.com
www.licor.com/env

LI-COR GmbH, Germany

Siemensstraße 25A
61352 Bad Homburg
Germany

Phone: +49 (0) 6172 17 17 771

envsales-gmbh@licor.com
envsupport-eu@licor.com

LI-COR Ltd., United Kingdom

St. John's Innovation Centre
Cowley Road
Cambridge
CB4 0WS
United Kingdom

Phone: +44 (0) 1223 422102

envsales-UK@licor.com
envsupport-eu@licor.com

LI-COR Distributor Network

www.licor.com/env/distributors

LI-COR is registered trademark of LI-COR, Inc. in the United States and other countries. All other trademarks belong to their respective owners.

For patent information, visit www.licor.com/patents.

© 2022 LI-COR, Inc. ISO 9001:2015 certified

The LI-COR logo consists of the words "LI-COR" in a bold, blue, italicized sans-serif font. A registered trademark symbol (®) is located at the bottom right of the word "COR".

980-15539 Rev. 3 07/22