

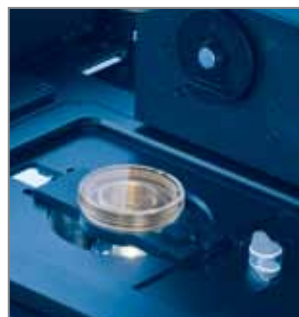

Molecular Machines & Industries

Laser Microdissection System

mmi CellCut Plus

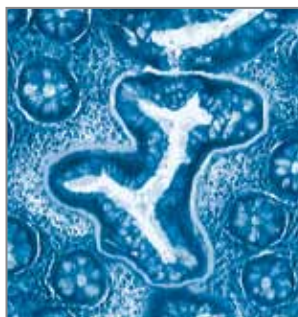
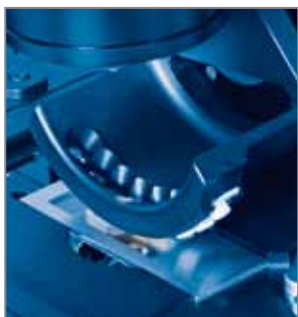

»Lead the way to
a new generation LMD Technology«

NEW GENERATION TECHNOLOGY

MMI is leading the way to provide scientists with innovative and sophisticated, solid state laser capture microdissection instruments. We are aiming to make this core technology in many scientific fields to be more efficient and cost effective. The patented adhesive cap technology is reliable, efficient and easy to use. Today, more than 500 customers in 65 countries rely on MMI solutions.

The modular concept of the MMI instruments offers a highly flexible instrument platform wherein optical tweezers, mechanical micromanipulation, high end confocal systems; fluorescence and other modules can be added to meet and surpass your requirements. The biggest benefit for our customers is an instrument that is easy to use and capable of performing the most complex research.

Today, more than ever, it is MMI's goal to provide you with the highest degree of precision possible. Our technology keeps your samples contamination free and your experimental results reproducible.

Our application support and service team is well-trained and experienced. They will help you to achieve your goals in optimizing your experiments to get accurate results.

The MMI team is committed to our customers and we stand behind our products. That is why we invite you to discover and innovate with us.

LEAD THE WAY to a new level of microdissection.

Sincerely yours,
The MMI Team

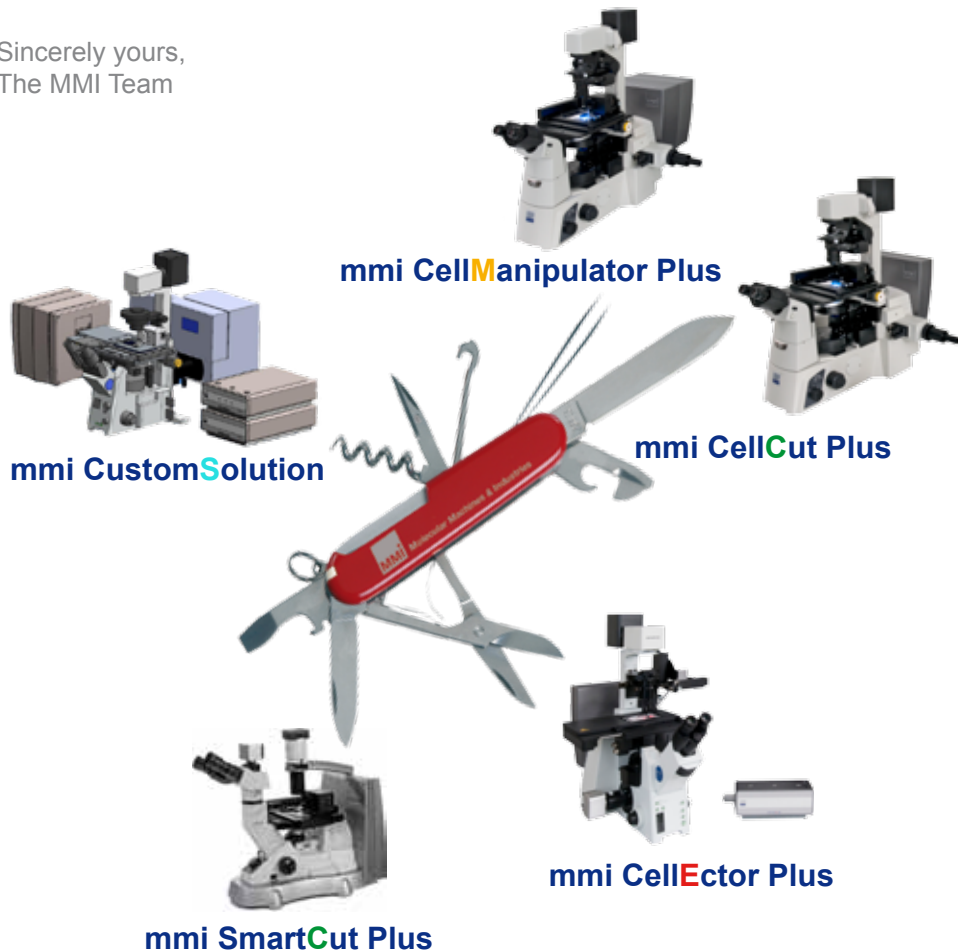

»Lead the way to cutting edge technologies«

FIRST CUTTING EDGE TECHNOLOGY

The mmi CellCut Plus system is the ultimate laser microdissection tool for researchers who want to isolate groups of cells, single cells and cell components for analysis across a wide range of applications.

The mmi CellCut Plus is ideal for scientists interested in the following areas of research: molecular or cell biology, genomics and proteomics, forensics, cancer and stem cell research. Clinically related applications such as molecular pathology, microbiology, and virology will also find the mmi CellCut Plus of primary importance and value.

Principles of laser microdissection

A The mmi CellCut Plus combines several proven, leading-edge technologies in providing an extremely fast, precise and clean isolation of cells from a wide range of microscopic samples. This is achieved by dissecting the areas of interest with an ultra precise UV-laser while maintaining it's morphology and ensuring the quality of the source material for subsequent downstream analysis.

High-speed ultra fine laser cutting

The mmi CellCut Plus system is fully controlled through the easy-to-use mmi CellTools software. This user-friendly program provides a live view of the microscopic sample on the monitor and allows the user to identify, mark and isolate the areas of interest easy and fast.

For cell isolation, the maintenance-free, solid-state UV-laser is focused through the microscope's objective onto a microscopic sample to enable a cut width as small as $0.3 \mu\text{m}$ with the 100x objective. This, combined with a very short (pico-second) pulse duration and a high repetition rate, provides an ultra precise and fast target excision.

Due to the very low ($< 1 \mu\text{joule}$) pulse energy of the laser, subsequent molecules like DNA, RNA and protein is unaffected by the laser dissection process. This means that cells and cell components from frozen- and/or paraffin-embedded tissues, archived material, smears, cytopspins, as well as living cells from cell cultures can be marked on the display of the microscope's image and microdissected without negative impact on the quality of the material for downstream applications.

Contamination-Free Isolation technology

B The unique mmi CapLift technology provides an automated and uncontaminated transfer of targets from the entire microscope slide into micro centrifuge tubes. The captured samples adhere to the mmi IsolationCap of the extraction tube, which snaps close to keep the sample free from contamination and ready for downstream molecular biological analysis.

Key customer benefits

- Easy to use and intuitive software, enabling focus on your research work
- Ultra high precision laser cutting for best laser microdissection results
- Ultra-short pulse, low average power laser for best DNA/RNA/Protein quality
- Maintenance free and certified long laser lifespan of $> 10'000$ hours
- Retained orientation and intact morphology of dissected samples
- Regions of interest can be inspected and processed again after microdissection

A Principle of fast, precise and contamination-free microdissection

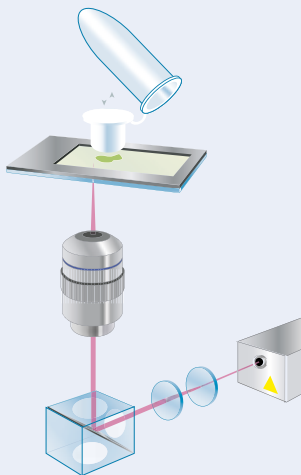

mmi LaserBox



B mmi CapLift technology



mmi MultiCap Lift



»Lead the way to
a wide range of applications«



APPLICATION EXAMPLES

Multiple cells in pathological samples

A Differences in genomic (DNA/RNA) and proteomic expression of any tissue type can be analyzed easily. For example, transverse sections of intestinal glands from colon tissues can be identified and quickly isolated for study of specific genes and the corresponding hormone response.

Single cells in hematology or cytology

B Single cells, such as a typical plasmoblast from a blood smear or other relevant cytological cells, can be identified, cut, and isolated automatically. With the remaining sample securely isolated in the mmi IsolationCap, downstream processing was never easier and safer.

Fluorescence-labeled cell components

C The precision of the mmi CellCut Plus system also enables you to simply locate and cleanly microdissect structures smaller than single cells. For example, chromosomes with detectable fluorescence in situ hybridization (FISH) signals can be isolated for subsequent investigation.

Forensic applications

D The mmi CellCut Plus system in forensic medicine is used, among other applications to isolate a single sperm from a vaginal smear for genetic analysis, greatly increasing the possibility of a positive match and therefore possibly leading to a criminal conviction.

Other samples

E Living specimens like *C. elegans* can also be examined with the mmi CellCut Plus system. Here, the living organism can be placed or fixed, between the membrane and a glass slide, in order to isolate and extract areas of interest as required by the individual experiment.

Live cells

Most stem cell lines are presently grown at high densities on mouse fibroblast “feeder layers”. Therefore, isolating specific pluripotent cells from the surrounding fibroblasts and differentiating cells needs to be fast and precise. With mmi CellCut Plus, there is a perfect balance between speed and precision, allowing the target stem cells to be isolated and re-cultured without any side effects, such as karyotype changes.

Basic laser micromanipulation

The mmi CellCut Plus system can also be used as a laser micromanipulation system. Single, short laser pulses produce small self-sealing holes in the plasma membrane of a living sample, which improves protoplast fusion or increases the transfection rates of exogenous substances.

Proteomic Applications

In proteomic research, several thousand cells are needed to run Western-blot or two dimensional gels. Using the mmi CellCut Plus enables scientists to quickly microdissect cells of interest without any potential damage, as compared to alternative methods like polymer thermo-excitation or cell projection.



»Lead the way to quick and clean isolation«

QUICK AND CLEAN TARGET ISOLATION

Unique system for sample preparation and sample protection

F Sample preparation of any source such as frozen or paraffin embedded, smears or cytopspins and chromosomes spreads, the mmi CellCut Plus system uses the established and proved mmi Membrane Slides. This special frame slide is covered with a thin membrane that is completely inert. The different types of samples are prepared on this membrane and are covered with a normal glass slide for protection against any contamination.

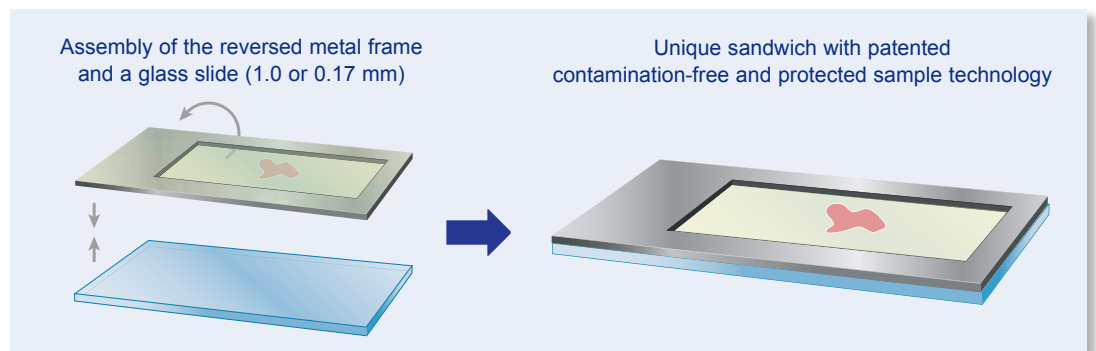

Selection and cutting

G Using the mmi CellCut Plus software, microdissecting the regions of interests are selected in any number of areas across the entire slide.

Fast, precise and clean isolation

The thin (0.3 μm at 100x) cutting path enables a precise and comfortable extraction of the selected areas at an outstanding speed without affecting its morphology or otherwise, negatively affecting the areas of interests. As a result, there is no loss in quality of the material used in subsequent steps. Even the viability of living cells is not affected and therefore, the cells, once selected, can be re-cultured. Depending on the sample type, several thousands of cells can be laser dissected under a minute.

Ready for downstream analysis

H The mmi IsolationCap allows the collection of target areas across the entire microscope slide. After microdissection, the mmi IsolationCaps are snapped into the micro centrifuge tubes to undergo extraction of the bio molecules. After using the recommended extraction reagents and at the desired incubation time, the extracted targets are now ready for further genomic and proteomic processing.

Key customer benefits

- Unique mmi sample preparation and protection system allowing contamination-free working conditions, RNase/DNase free and safe from environmental contamination
- Simple and comfortable working processes for more efficient results
- The only system which allows reworking already isolated areas
- Best results are even achieved from limited source of material
- Keeps you in control of your research work without compromising speed and efficiency

F Sample preparation on frame slide with PET or PEN membrane

Cryo or paraffin-preserved tissue

Single cells, smears or cytopspins

Chromosomes

Others, e.g. sperms, C. elegans

G Easy cell selection

H Selected target Incubation and centrifugation

»Lead the way to
live cell microdissection«



THE NEW LIVE CELLCHAMBER

Using the
mmi Live CellChamber

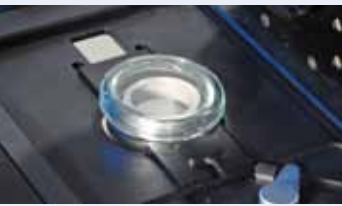

The isolation and enrichment of individual live cells for culture and differentiation experiments or for their proteomic and genomic analysis is of increasing interest in stem cell research, cancer research and tissue engineering. The mmi CellCut Plus in combination with the newly developed mmi LiveCellChamber enables contamination-free isolation of live cells in living culture.

Components of the new mmi Live CellChamber

- Membrane ring, for the initial cultivation of cells
- Cell culture dish, to house the membrane ring with seeded cells
- The microdissection chamber, UV-permeable

(Note: All components are sterilized and ready to use.)

The Workflow

Adherent cells are grown in a special metal ring on a membrane inside a petri dish. Once a desired cell density is reached, the membrane ring is transferred to the adhesive area of the microdissection chamber. The cell or cells of interest are selected and cut using Laser Microdissection. In addition, unwanted cells can be destroyed or ablated by using individual laser shots. The cell chamber is then removed and only the cells of interest remain in the microdissection chamber.

Repeated selection of wanted cells: This process can be repeated using the same metal ring in a new microdissection chamber to select and separate more than one cell type. Once isolation is complete, sufficient medium is added to the microdissection chamber and the cells can be re-cultivated.

- Seed cells and cultivate to the desired cell density. Visualize your cells of interest with phase contrast, immuno labeling, etc.
- Transfer the membrane ring with cells into the mmi microdissection chamber.
- Selection of cells via Lasermicrodissection.
- Isolate cells by removing the membrane ring with unwanted cells. Reculture the cells of interest and if desired, the depleted fraction.

(Repeat if desired)

Key customer benefits

- Contamination free process
- No enzyme treatments (e.g. trypsin) or other potentially harmful reagents are required
- Fastest and easiest live cell isolation
- Re-culture of the cells in the mmi Live CellChamber
- 18 well Live CellChamber for high throughput application

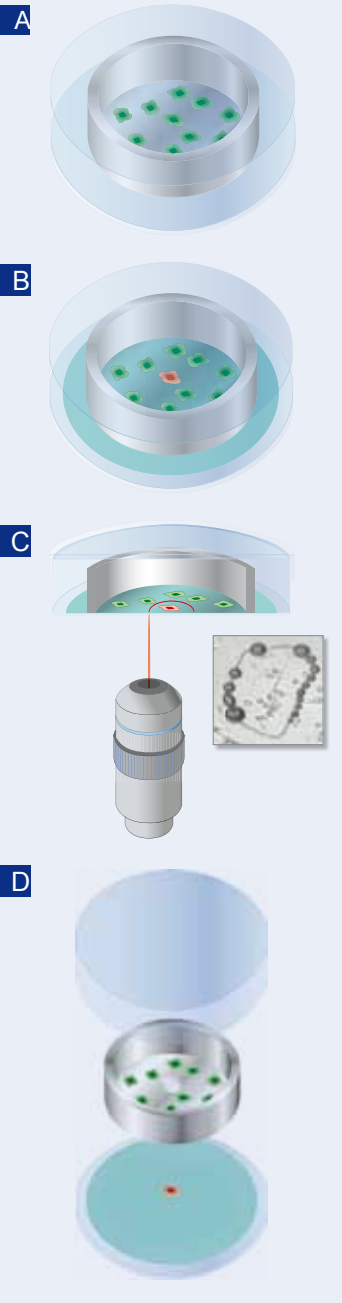

»Lead the way to
easy operation«

INTUITIVE MMI CELLTOOL SOFTWARE

The mmi CellTools Software is used to control the mmi CellCut Plus system. Its graphical user interface allows the precise and intuitive identification and selection of the areas of interests to be excised for the isolation processes. In addition, it provides full control of the system, laser cutting parameters, type of objective used and the specific camera settings related to each different application. With a fully motorized microscope as its basis, even the automated microscope functions such as objective changes, condenser settings and fluorescence turret changes can be initiated via the mmi CellTools software. With this user-friendly software combined with the optional PenScreen operation, the mmi CellCut system simply makes the most complex experiments possible and will take you to new levels of efficiency.

Overview, easy navigation and positive target identification

E Using a low-magnification objective, an overview scan of the entire microscope slide is taken, allowing easy navigation of the whole slide.

Serial Section allows easier isolation of unstained samples

F The patented serial section function allows the marking of target regions onto one or more unstained sections by using a stained top section as a template. Differences in shape, angle and position are automatically compensated by the software giving highly accurate results. This saves time and money by reducing reagent usage and limits the RNA degradation.

Z-Drill for low power cutting of thick and wet tissue

G The Z-Drill function allows the cutting of wet and thick tissue without the need for increased laser power. The laser is refocused through the sample and so facilitates cutting in a spiral. Providing a smooth, clear cut without the need of a high powered laser the result is superior cutting with minimised tissue damage.

Laser control

The common laser parameters such as speed, focus and power can be set to match the individual needs of each application, sample or objective. Once set, the parameters are stored for easy retrieval and can be edited at any time.

Automated full-slide selection and extraction

While the areas of interests are all over the entire microscope slide, you can select and extract from the whole slide area. This saves a significant amount of time in the isolating process. Together with the mmi MultiSlide and mmi MultiCap options, the system automatically extracts targets from up to three slides and collects in up to eight different mmi IsolationCaps.

Auto documentation

All the relevant data within a session can be stored via the auto documentation mode. This includes the number and size of the cut-out areas, as well as instrument settings and laser parameters. The isolated targets are documented by the mmi CellCut Plus system during the cutting and isolation process and pictures of the remaining samples are also automatically taken and saved. This enhances traceability of your research work and a given proof of a clear, clean and quick isolation process.

Predefined Target Positioning (or PTP)

H PTP is a patented solution allowing precisely controlled, contamination-free collection of individual cells.

Additional customer benefits

- Best image available, full screen resolution up to 24" monitors
- Fast slide scanning speed

E Display for easy navigation

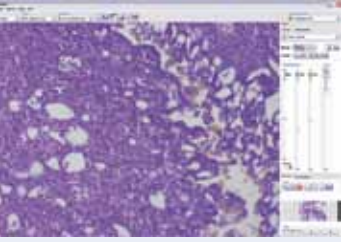

F Serial Section function

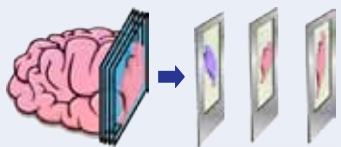

G Z-Drill function

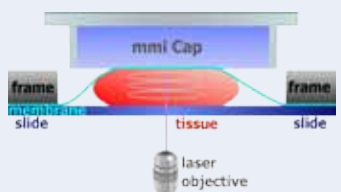

H Adjust detailed settings for defined collection of target cells (PTP)

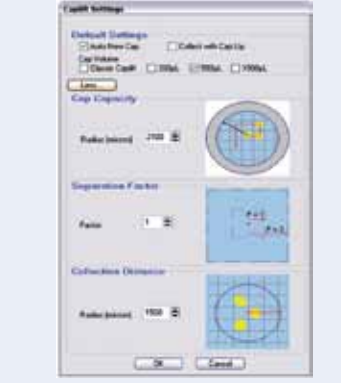

Dissect and control collected cells on the adhesive cap



»Lead the way to
System Integration«



SYSTEM INTEGRATION

Inverted microscopes are designed to provide researchers with a high performance and versatility required for a wide range of research activities. The mmi CellCut Plus is available for various inverted microscopes, maintaining all the properties and options of these research instruments.

Optical bench flexibility

With multiple ports and dual-level laser integration, the microscope offers the “optical bench flexibility” enabling the use of different modules and imaging technologies to be used without any limitation or extensive equipment changes.

Standard fluorescence without limits

A B The dual-level coupling of the solid state UV-cutting laser also ensures that the microscope may be used fully for the whole range of fluorescence applications. For example, six fluorescence cubes can be used and therefore, additional or specialized dichroic optics or external filter wheels are not necessary. In conjunction to the mmi CellTools software’s freeze mode for fluorescence images, the mmi CellCut Plus system provides a perfect combination for fluorescence applications and laser microdissection adaptable to your needs.

The mmi SidePort version

C The newly designed sideport allows integration of the laser microdissection system from the side. An extra port is provided in order to keep all existing microscope parts open. The coupling of the extra port between the fluorescence and objective turret keeps the benefit of the dual level design. The unique side port option allows easy integration e.g. confocal, spinning disc or RAMAN systems.

The mmi CellCamera

D The ultra high sensitive digital mmi CellCamera with its compact dimensions and outstanding performance supports your most complex demands.

- MXF285c mmi CellCamera for outstanding image quality and colour fidelity
- IEEE1394b bilingual CCD camera (FireWire™ progressive scan CCD camera)
- Ultra high sensitivity Exview CCD technology and dynamic range
- Advanced peltier cooling concept for exposure times up to 30 sec
- 1392 x 1040 pixels
- High Quality 12 Bit slow scan mode for lowest readout noise
- Up to 20 full frames per second
- Automatic shutter, automatic/manual white balance

Key customer benefits

- No laser interference on microscope functions due to dual level coupling
- All standard microscope functions remain intact while using the mmi CellCut Plus
- Freeze mode for fluorescence images avoids bleaching of cells
- High quality imaging and contrast with actively cooled mmi CellCamera
- Cold fluorescence excite light source has 10x longer lifespan than regular lamp allows with alignment free operation and no heating of the samples
- Maximum upgrade flexibility with mmi SidePort

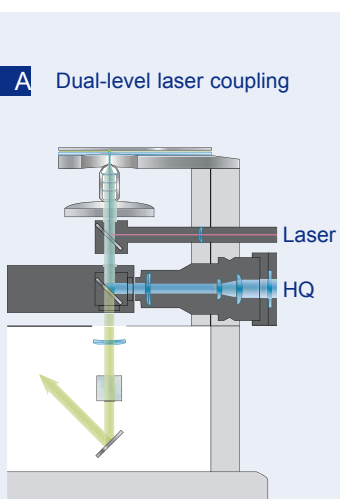

»Lead the way to
the future«

UPGRADES AND SERVICES

The mmi Upgrades and Options

For more advanced functions and different requirements, the mmi CellCut Plus system can be upgraded and complemented with a number of modular additions.

E PenScreen – A sensitive PenScreen 22“ can easily be used to operate the mmi CellCut Plus system in selecting areas of interests directly on the system display.

F The mmi CellExplorer Version 2011 became now even more user friendly and versatile. Image analysis software which automatically identifies cells based on selection criteria distinctly specified by morphological parameters predefined individually as such in size, shape, staining and fluorescent markers to allow for automatic dissection. New statistical options, complete slide overview up to 40x.

The mmi Services

G MMI as a leading supplier of LCM instruments also provides a variety of services and application support. This support is offered throughout the whole value-added chain of sample staining, over microdissection to nucleic acid and protein isolation and analysis. MMI and its partners provide worldwide technical support and answers to your questions. Furthermore, the mmi Bibliographies feature recent advancement in the developments of protocols.

MMI also offers on-site protocol development through our own applications specialists' right in your laboratory with your own equipment and personnel providing you with solutions suited to your individual needs.

Other mmi services; available end-user training either in-house or on-site, protocols for various applications, scientific publication support, service and maintenance contracts, etc.

The mmi Consumables

H The mmi MembraneSlides, available in PET or PEN mounted on metal frames in RNase free quality.

J The mmi IsolationCaps, available in different sizes for specific applications such as fluorescence or bright field imaging.

The mmi Live CellChamber
with membrane and special Petri dish for live cell cultures.

The mmi μ -Slide 18-well
for high throughput live cell application. Live cell isolation with mmi IsolationCap.

The mmi Director Slides
are non-contact laser microdissection slides for faster and simpler Proteomic Analysis. They are utilizing a Laser Induced Forward Transfer (LIFT) technique to isolate cells of glass slides.

The mmi H&E Staining Kit
is the first choice for fast LMD and RNA friendly basic staining: the whole procedure is done in less than 5 minutes.

E Screen for on-screen target identification

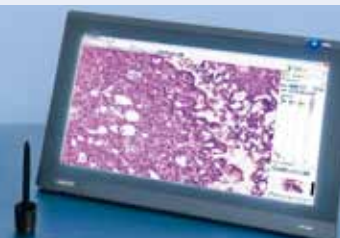

F mmi CellExplorer Software

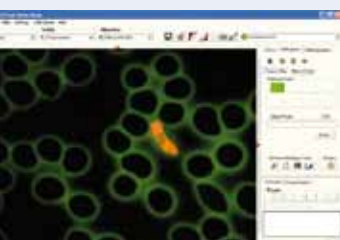

G mmi Bibliographies



H mmi MembraneSlides

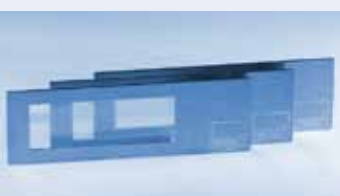

J mmi IsolationCaps



»Lead the way
in most effective cell isolation«



MMI SYSTEMS

mmi SmartCut Plus

Our most compact Laser Microdissection system offers the same laser mmi CapLift isolation technique and objectives as the mmi CellCut Plus. Easy and convenient to handle, the mmi SmartCut Plus requires no extensive technical training and does even fit under a laminar flow hood. The mmi SmartCut Plus is especially developed for all routine applications and researchers in cell biology, molecular pathology, forensic medicine prenatal diagnostics teaching and many other fields will greatly benefit from its excellent price performance ratio.

	mmi CellCut Plus	mmi SmartCut Plus
Microscope		
Olympus	IX71or IX81	CKX41
Nikon	Ti-E, S, U	TS100
Options		
mmi CellExplorer	●	●
PenScreen	●	●
mmi MultiCap	●	●
mmi MultiSlide	●	●
Fluorescence, Excite	●	●
Upgrades		
mmi CellEctor Plus	●	●
mmi CellManipulator Plus	●	●
mmi SidePort	●	●
Confocal, Spinning Disc	●	●

mmi SmartCut Plus Olympus



mmi Smartcut Plus Nikon



A Prepare sample directly on mmi Membrane Slides



B mmi CellRobot



C mmi CellPump



mmi CellEctor Plus

Molecular analysis of pure enriched cell populations or even of single cells becomes essential for molecular patient profiling in the future. Therefore, we developed a new analysis and cell sorting device.

A The isolation of single and rare cells from tiny sample sources is a prerequisite for their genotypic and phenotypic characterization. The mmi CellEctor Plus is the starting point for a new integrated work flow. It facilitates the automated isolation of any type of single and rare cells in three steps:

1. Cell Recognition with mmi CellExplorer Software
2. Cell Acquisition fully automatic and motorized
3. Cell Deposition fully automatic and motorized

Cell deposition onto any desired analysis device, e.g. a reaction grid, like Ampligrd, an Multi Chamber, a PCR-tube or a microfluidic device. The mmi CellEctor Plus is an adjustable and open platform for any assay format. It closes the gap between frequent and rare cell sorting in Cancer Research & Oncology, Immunology & Virology, Stem Cell Sciences, and many other applications in: Biomedical Research, Cellular Diagnostics, Microbiology & Virology, Environmental Ecology, Forensics, Material Sciences.

B mmi CellRobot

- 3 Axis fully motorized & software controlled
- Easy swivel device to allow full access to the stage
- Patented capillary protection and easy adjustment

C mmi CellPump

- Fully motorized and software controlled
- High precision with 2 Nanoliters
- Patented design for easy fill and flush



»A new generation of professional optical multibeam tweezers«

MMI SYSTEMS

mmi CellManipulator Plus

E The mmi CellManipulator Plus is the world's only and most powerful commercial optical multibeam tweezer system. This optical trap enables ultra-precise, contact-free manipulation of microscopic particles and the measurement of intracellular activities. It can be used to study cell-cell interactions, in vitro fertilization or cell fusion. Cell sorting and cell positioning can also be accomplished together with an optional exclusive mmi 4-Quadrant detector enabling the measurement of binding forces or viscosities at sub cellular level.

D Function

The mmi CellManipulator Plus uses a ND-YAG infrared laser with a long wavelength of 1064 nm with up to 8 W of trapping power. The wavelength of the laser does not interfere with the integrity of the living specimens. The intensely focused laser beam can hold, move, rotate, join, separate, stretch or otherwise manipulate up to ten microscopic objects simultaneously in three dimensions. The size of the particles can range from 0.1 to 200 micros in liquids. (System complies with IEC608225-1 Am. 2:2001: Class 1 laser product)

High-performance software

Advanced software enables comfortable, contact-free, high-precision manipulation of selected particles inside the entire field of view. Each beam can be moved separately, and allows the user to define groups of tweezers points, which can be pushed, rotated, contracted and expanded, as groups or individually as required.

D The Principle of Laser Micromanipulation

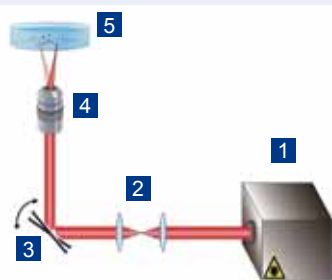

- 1 YAG Laser 1064 nm, 8.0 Watt
- 2 Focusing lens
- 3 Galvo scanners 2 kHz
- 4 Objective with high NA
- 5 Cells, particles in solution

Molecular motor studies

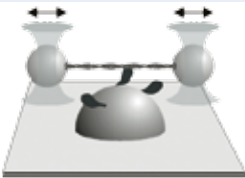

E mmi CellManipulator fully integrated with mmi CellCut Plus



mmi CellManipulator with FV1000



4 Quadrant Detector



mmi CellManipulator Plus	Nikon Ti	Olympus IX81
Options		
Inverted Microscope	●	●
Upright Microscope	●	●
Confocal Integration	A1	FV1000
Spinning Disc	●	●
Combined with RAMAN	●	●
TIRF, DIC, Phase Contrast	●	●
Upgrades		
4QD Force Measurement with Data Analysis	●	●
2nd Tweezers level 2x10 Traps x,y,z	●	●
mmi CellCut Plus LMD	●	●
mmi CellEctor Plus Cell Sorting	●	●
PEN Touch screen 22"	●	●
Piezo x,y and / or z stage	●	●
EMCCD Hamamatsu or Andor	●	●
Integration into Zeiss, Leica and upright Microscopes on request		

Key customer benefits

- Trapping force up to 800 pN with longterm stability
- Unique professional standards in expanding the frontiers of research
- Comfortable and safe multibeam operation of up to 2 x 10 tweezers points
- High performance laser which ensures the integrity of the living specimens
- Contact-free and precise movement of selected particles individually or in groups
- Easy operation with live video and documentation
- Integrated Force measurement and data analysis
- Maximum flexibility for up grade & expansion
- Customized solutions

mmi CellCut Plus SPECIFICATIONS

mmi CellCut Plus	Specification
System components	
Samples	For all application-relevant samples (cryo or paraffin-preserved tissues, single cells, cell compartments, cytospins, chromosomes, etc.)
Microscopic Systems	Olympus IX71 or IX81 Nikon Eclipse Ti-S, Ti-E
Picosecond UV, Solid-State Laser	Computer-controlled System complies with IEC 60825-1 2007
CapLift technology	SW-controlled, covering full slides unique, contamination-free sandwich technology
Nosepiece, UIS2 objectives	6-position nosepiece, NA and WD specified to be selected according to application requirements Excellent UV/IR transmission
Digital camera with ultra high sensitivity	Digital colour Digital monochrome: 1,392 x 1,040 pixels Compact housing and FireWire connection 800 Mbits/s
UV-Cut software basic functions	Laser energy and focus control Full slide and Petri dish control Inspection mode with positive target identification Saving multi user profiles MultiGroup function across entire sample/slides Autodocumentation for sample, images and parameters Serial section function Z-Drill function
PC and monitor	Specifications will be continuously updated according to market development Windows XP 24" LCD monitor
Motorised stage	Computer-controlled for high-precision movement/cutting Travelling range: 112 x 74 mm Step width: 0.075 µm Repositioning accuracy: 1 µm
MultiSlide (motorised), PLUS	For microdissection of up to 3 slide assemblies
Motorised nosepiece	
Z-focus (for IX81)	10 nm step size and 1 µm reproducibility independent of movement Direction, fine/coarse movement with 3 mm/sec max. speed
Condenser/Contrast methods	BF, phase- and RC contrast and DIC, application-oriented
Fluorescence	6-cube turret, dual-level laser coupling
Options	
PenScreen system operation	Sensitive 22" pen screen monitor for user-friendly system operation allows direct target identification with a special pen
mmi CellExplorer image analysis software	Identifies and cuts out automatically defined targets based on user settings
MultiCap (motorised)	Allows automatic collection of targets in up to 8 different IsolationCaps
Possible CellCut Plus system upgrade	
mmi CellManipulator Plus optical tweezer system	Ultra precise, contact-free manipulation of microscopic particles with up to 2 x 10 independent beams based on a high-quality, YAG-type infrared laser
mmi CellEctor Plus	A fully automated single cell sorting device



Swiss Precision



MMI AG
Flughofstrasse 37
8152 Glattbrugg, Switzerland
Phone: +41 44 809 10 10
Fax: +41 44 809 10 11
Mail: info@molecular-machines.com
www.molecular-machines.com

MMI GmbH
Breslauer Strasse 2
85386 Eching, Germany
Phone: +49 89 319 048 40
Fax: +49 89 319 048 59
Mail: info@molecular-machines.com
www.molecular-machines.com

MMI Inc.
P.O. Box 348
Haslett, MI 48840, USA
Phone: +1 603 629 9536
Fax: +1 321 978 0304
Mail: sales_us@molecular-machines.com
www.molecular-machines.com