

# Technical Specifications

## EIGER2 R CdTe 1M

*Document Version v1.6.0*

**DECTRIS Ltd.**

5405 Baden-Daettwil  
Switzerland  
[www.dectris.com](http://www.dectris.com)



# CONTENT

<b>CONTENT</b>	<b>i</b>
<b>DOCUMENT HISTORY</b>	<b>iii</b>
Current Document . . . . .	iii
Changes . . . . .	iii
<b>1 GENERAL INFORMATION</b>	<b>1</b>
1.1 Contact and Support . . . . .	1
1.2 Explanation of Symbols . . . . .	1
1.3 Warranty Information . . . . .	2
1.4 Disclaimer . . . . .	2
<b>2 USE OF THE EIGER2 R CDTE 1M</b>	<b>3</b>
2.1 Product Return and Recycling . . . . .	3
<b>3 TECHNICAL SPECIFICATIONS</b>	<b>4</b>
3.1 Specifications . . . . .	4
3.1.1 Detector . . . . .	4
3.2 Ratings . . . . .	5
3.2.1 Detector . . . . .	5
3.2.2 Power Supply Unit . . . . .	5
3.2.3 Detector Control Unit . . . . .	6
3.2.4 Thermal Stabilization Unit . . . . .	6
3.3 Ambient Conditions . . . . .	7
<b>4 DETECTOR DIMENSIONS AND CONNECTORS</b>	<b>8</b>
4.1 EIGER2 R CdTe 1M Detector . . . . .	8
4.1.1 Technical Drawing . . . . .	8
4.1.2 Front Side of the Detector . . . . .	9
4.1.3 Back Side of the Detector . . . . .	10
4.1.4 Status LEDs . . . . .	11
4.1.5 Connectors and Connecting Cables/Pipes . . . . .	11
4.2 Detector Control Unit . . . . .	12
4.2.1 Configuration . . . . .	12
4.2.2 Connectors . . . . .	13
4.3 Thermal Stabilization Unit . . . . .	13
4.3.1 In-Vacuum Operation . . . . .	14
<b>5 INSTALLING THE DETECTOR SYSTEM</b>	<b>16</b>
5.1 Transport Considerations . . . . .	16
5.2 Mounting . . . . .	16
5.2.1 Mounting from Below . . . . .	16
5.2.2 Mounting from Above . . . . .	17
5.3 Grounding of the Detector . . . . .	17
5.4 Connection to Dry Air or Nitrogen . . . . .	17
5.4.1 In-Vacuum Use . . . . .	18
5.5 Connection to Thermal Stabilization Unit . . . . .	18
5.6 Mounting the Detector Control Unit . . . . .	19
<b>6 TEMPERATURE AND HUMIDITY CONTROL</b>	<b>20</b>

<b>7</b>	<b>OPERATION PROCEDURE</b>	<b>21</b>
7.1	Getting Started . . . . .	21
7.2	Startup Procedure . . . . .	21
7.3	Turning Off the Detector . . . . .	21
7.4	Vacuum Operation . . . . .	22
7.4.1	Ambient Conditions for In-Vacuum Use . . . . .	22
7.4.2	Operation Procedure In-Vacuum . . . . .	22
7.5	Storing the Detector . . . . .	23
7.6	Cleaning and Maintenance . . . . .	23
<b>8</b>	<b>SAFETY INSTRUCTIONS FOR CDTE SENSORS</b>	<b>24</b>
<b>9</b>	<b>TROUBLESHOOTING</b>	<b>25</b>

## DOCUMENT HISTORY

### Current Document

**Table 1:** Current Version of this Document

Version	Date	Status	Prepared	Checked	Released
v1.6.0	2020-09-08	release	LW	SB, MM	LW

### Changes

**Table 2:** Changes to this Document

Version	Date	Changes
v1.0.0	2017-04-09	First release.
v1.2.0	2017-09-04	EIGER2 R 500K integration.
v1.3.2	2017-09-04	PILATUS3 and EIGER2 R 500K API documentation integration.
v1.4.0	2018-06-19	EIGER2 Si detector series integration
v1.5.0	2020-03-02	New layout and rework of the technical specifications.
v1.5.1	2020-06-08	Fixed EIGER2 16M image of ground plate.
v1.6.0	2020-09-08	EIGER2 CdTe detector series integration.

## 1. GENERAL INFORMATION

### 1.1. Contact and Support





Address: DECTRIS Ltd.  
Taefernweg 1  
5405 Baden-Daettwil  
Switzerland

Phone: +41 56 500 21 02  
Fax: +41 56 500 21 01

Homepage: <http://www.dectris.com/>  
Email: [support@dectris.com](mailto:support@dectris.com)

Should you have questions concerning the system or its use, please contact us via telephone, mail or fax.

### 1.2. Explanation of Symbols

<b>Danger</b>	<b>#0</b>
	<b>Danger blocks are used to indicate immediate danger or risk to personnel or equipment.</b>
Warning	#0
	Warning blocks are used to indicate danger or risk to personnel or equipment.
Caution	#0
	Caution blocks are used to indicate danger or risk to equipment.
Information	#0
	Information blocks are used to highlight important information.

### 1.3. Warranty Information

Caution

#1



Do not ship the system back before you receive the necessary transport and shipping information.

---

### 1.4. Disclaimer

DECTRIS has carefully compiled the contents of this manual according to the current state of knowledge. Damage and warranty claims arising from missing or incorrect data are excluded.

DECTRIS bears no responsibility or liability for damage of any kind, also for indirect or consequential damage resulting from the use of this system.

DECTRIS is the sole owner of all user rights related to the contents of the manual (in particular information, images or materials), unless otherwise indicated. Without the written permission of DECTRIS it is prohibited to integrate the protected contents in this publication into other programs or other websites or to use them by any other means.

DECTRIS reserves the right, at its own discretion and without liability or prior notice, to modify and/or discontinue this publication in whole or in part at any time, and is not obliged to update the contents of the manual.

## 2. USE OF THE EIGER2 R CDTE 1M

The EIGER2 R CdTe 1M detector system has been designed for the detection of X-rays produced by synchrotrons or laboratory sources. It is intended for indoor use only. For other applications, please contact DECTRIS technical support for additional information.

Caution

#2



Improper use of the DECTRIS detector system can compromise its safety and its functionality is no longer guaranteed.

Caution

#3



When using the detector in vacuum strictly follow the in-vacuum instructions given in this document.

### 2.1. Product Return and Recycling

We recycle DECTRIS detector systems that are no longer suitable for use. If you are not using your DECTRIS detector system any more, send it back to us. We will make sure that your system is responsibly and safely recycled. This is free for customers who purchased a new DECTRIS detector system.



## 3. TECHNICAL SPECIFICATIONS

### 3.1. Specifications

#### 3.1.1. Detector

**Table 3.1:** Technical Specifications

Number of modules (W x H)	1 x 2 = 2
Sensor material	Cadmium Telluride (CdTe)
Sensor thickness	750 $\mu\text{m}$
Pixel size (W x H)	75 $\mu\text{m}$ x 75 $\mu\text{m}$ = 5625 $\mu\text{m}^2$
Module size (W x H)	77.1 mm x 38.4 mm = 2961 mm <sup>2</sup>
Pixel array format (W x H)	1028 pixel x 1062 pixel = 1 091 736 pixel
Active area (W x H)	77.1 mm x 79.65 mm = 6141.015 mm <sup>2</sup>
Intermodule gap	hor. - pixel, vert. 38 pixel
Intra module gap	2 pixels wide vertical gap in the center of each module
Defective pixels	< 0.2%
Image bit depth	32 bit
Readout bit depth	16 bit
Maximum count rate	9.8 x 10 <sup>8</sup> photons/s/mm <sup>2</sup>
Adjustable threshold range	4 keV to 30 keV
Energy range	8 keV to 25 keV
Number of thresholds	two independent thresholds
Readout time	continuous readout, with zero dead time
Maximum frame rate <sup>1</sup>	100 Hz
Point-spread function	1 pixel (FWHM)
Connection to control unit	1 x LC/UPC duplex connectors
Power supply	External power supply unit
Software interface	HTTP REST interface (via network connection)
Dimensions (W x H x D)	114 mm x 133 mm x 241.5 mm
Weight	4.7 kg
Overvoltage category	II
Means of protection	I (power supply)

<sup>1</sup> One frame per exposure, i.e. single-threshold or difference image

**Table 3.1:** Technical Specifications - continued

Pollution degree	II
Maximum operating altitude	2000 m a.s.l.



## 3.2. Ratings

### 3.2.1. Detector

**Table 3.2:** Power Ratings

Detector power input	+12 V DC, 85 W
Detector external trigger input	High level: 2.1 – 5.0 V Low level: 0.0 – 0.8 V
<div style="background-color: #ffff00; padding: 5px; display: flex; justify-content: space-between;"> <span>Caution</span> <span>#4</span> </div> <div style="margin-top: 5px;">  Absolute maximum is 5V. Applying a higher voltage will damage the detector.         </div>	
External trigger input impedance	47 kΩ
Detector trigger output	High level: 2.3V to 3.3V Low level: 0.0V to 0.6V Max. current: 24 mA

### 3.2.2. Power Supply Unit

Information	#1
 Please consult the user documentation of the Mean Well GST160A12 power supply unit for details.	
<div style="background-color: #ffff00; padding: 5px; display: flex; justify-content: space-between;"> <span>Caution</span> <span>#5</span> </div> <div style="margin-top: 5px;">  Only use the power supply delivered with the EIGER2 R CdTe 1M.         </div>	

**Table 3.3:** Power Supply Unit Ratings

Power supply unit power input	<b>Input</b> 85 VAC to 264 VAC 47 Hz to 63 Hz 1 A to 1.85 A <b>Output</b> 12 VDC max. 11.5 A 138 W
-------------------------------	---

**Table 3.3:** Power Supply Unit Ratings - continued

AC connector	IEC-320-C14 input inlet
Case dimensions (W x H x D)	72 mm x 35 mm x 175 mm
Weight	0.7 kg



### 3.2.3. Detector Control Unit

Information	#2
 Please consult the user documentation of the DELL PowerEdge R240 for details.	

**Table 3.4:** Detector Control Unit Ratings

Detector control unit power input	1 x 100 VAC to 240 VAC, 50/60 Hz, 1 A to 3 A, 250 W (Bronze)
Dimensions (W x H x D)	434.0 mm x 42.8 mm x 595.63 mm
Weight	<10.6 kg
Chassis	1U

### 3.2.4. Thermal Stabilization Unit

Information	#3
 Please consult the user documentation of the SMC HEC 002-A5B thermal stabilization unit for details.	
Caution	#6
 The maximum allowable coolant pressure is 3 bar.	

**Table 3.5:** Thermal Stabilization Unit Ratings

	Value
Thermal stabilization unit power input	Single phase 100 VAC to 240 VAC, allowable voltage range $\pm 10\%$ , 50/60 Hz, 8 A (100 VAC) to 3 A (240 VAC)
Dimensions (W x H x D)	270 mm x 393 mm x 436 mm
Weight	17.5 kg
Typical flow	3 L min <sup>-1</sup>
Maximum operation pressure	3 bar

### 3.3. Ambient Conditions

Caution

#7



The EIGER2 R CdTe 1M detector is equipped with a temperature and a humidity sensor. When either sensor detects that the operating conditions are not met, the detector will shut off. However, as the sensors may not prevent damage, temperature and humidity should be monitored to avoid breaching the operation limits.

The EIGER2 R CdTe 1M detector is designed for indoor use only. The ambient conditions shown in table 3.6 must be satisfied. The stated values are for the ambient conditions.

Values inside the detector, in particular due to the dry-air or nitrogen supply, are different. These are described in section 5.4 and chapter 6.

**Table 3.6:** Detector Operating Ambient Conditions

Ambient Condition	Value
Operating temperature	+20 °C to +35 °C
Operating humidity	<80 % at 20 °C, non-condensing
Storage temperature	+15 °C to +40 °C
Storage humidity	<40 % at 20 °C, non-condensing

Caution

#8



Please consider the following points when storing the detector

- Make sure the temperature and the humidity inside the transport box does not exceed the specified range (use of a drying agent is required).
- Ensure that no condensation moisture develops if the detector is stored at low temperature.

## 4. DETECTOR DIMENSIONS AND CONNECTORS

### 4.1. EIGER2 R CdTe 1M Detector

#### 4.1.1. Technical Drawing

Information

#4



3D step files of the EIGER2 R CdTe 1M detector are available on request. Please contact DECTRIS technical support for more information.

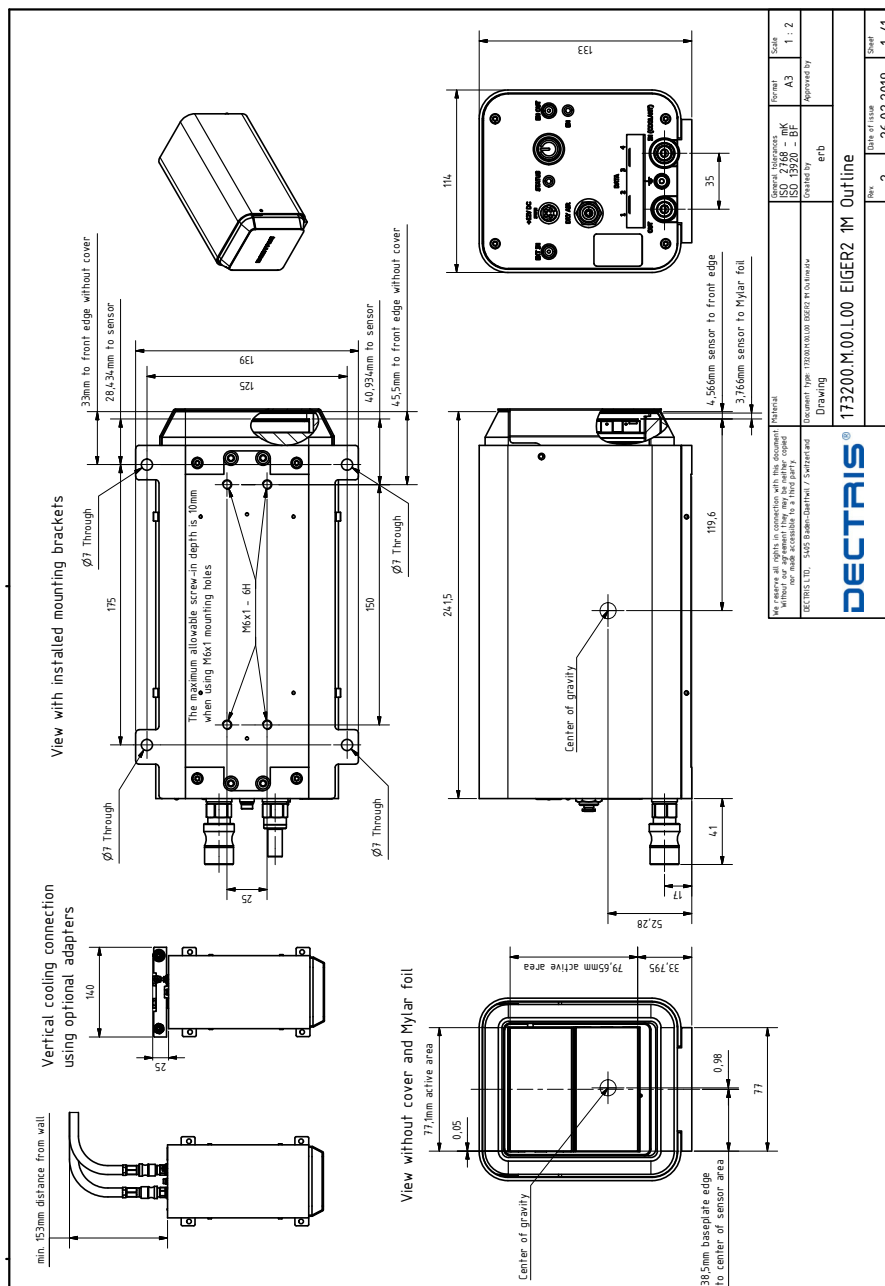

**Figure 4.1:** Drawing of the EIGER2 R CdTe 1M Detector (also printed separately in the user documentation folder)

#### 4.1.2. Front Side of the Detector

##### Danger

#1



**Danger of electric shock. Do not touch the Mylar® foil. The sensors behind the Mylar® foil are operated at high voltages. Touching the Mylar® foil can cause an electrical shock.**

##### Warning

#1



Do not touch the Mylar® foil to avoid damage of the sensors.

##### Caution

#9



The cover may not protect the detector from a direct beam.

The detector comes with a protective cover (1.5 mm, Steel) for the front window, which should only be removed during operation. The sensors are behind a 12 µm thick Mylar® (PET) foil coated with aluminum to protect them from humidity, dust and from being touched.



**Figure 4.2:** The EIGER2 R CdTe 1M Detector with the Cover Removed (front view)

### 4.1.3. Back Side of the Detector



**Figure 4.3:** The EIGER2 R CdTe 1M Detector (back view)

#### 4.1.4. Status LEDs

**Table 4.1:** The Meaning of the Status LEDs on the Detector Back Plane

LED	Behavior	Description
EN	Orange	Indicates the detector is in counting mode.
STATUS	Green steady	Detector running and hardware OK.
	Green blinking	Detector hardware OK, detector in Standby or Startup mode. ⇒ Press power button to turn on the detector.
	Red blinking	Detector may be overheating or humidity too high ⇒ Check cooling system and dry air supply
	Off	Detector has no power ⇒ Check the power adapter and mains connection.



#### 4.1.5. Connectors and Connecting Cables/Pipes

**Table 4.2:** Electric Connectors and Connecting Cables

Connector	Description
DATA	<p>1 x LC/UPC duplex connectors DATA 1 -&gt; detector control unit port 1</p> <p>The unused data ports are closed with an EMI plug. Do not remove the plugs. Use Single Mode fiber optic patch cable with LC/UPC duplex connectors at both ends. We recommend to use the optic patch cables that are supplied with the detector system. Detector and detector control unit are equipped with 10GBASE-LR Single Mode SFP+ optical transceivers. Do not replace the optical receivers, as proper function of the detector system cannot be guaranteed otherwise. Please contact support@dectris.com if you need replacement transceivers.</p> <div style="background-color: yellow; padding: 5px; display: flex; justify-content: space-between;"> <span>Caution</span> <span>#10</span> </div> <p> There must be a 1 x LC/UPC duplex connectors point-to-point connection between detector and detector control unit.</p>
POWER	DC power connector (see tables 3.2 and 3.3)
EXT IN	External trigger input (see table 3.2) Use a Lemo® Type 00 (NIM/CAMAC) cable.
EN OUT	Enable out, high when counting is enabled. Use a Lemo® Type 00 (NIM/CAMAC) cable.



**Table 4.2:** Electric Connectors and Connecting Cables - continued

Connector	Description
	Functional ground
<div style="background-color: #003366; color: white; padding: 5px; display: flex; justify-content: space-between;"> <span>Information</span> <span>#5</span> </div>	
<div style="display: flex; align-items: flex-start;"> <div style="margin-right: 10px;">  </div> <div> <p>Although the detector might be already grounded via the mounting bolts, the detector should be grounded additionally via the functional ground connector at the back to establish a defined grounding.</p> </div> </div>	

## 4.2. Detector Control Unit

### 4.2.1. Configuration

Caution
#11



Do not access or modify the operating system of the detector control unit.

The user interface of the detector control unit is accessible using a web browser. The detector control unit does not need any connections other than the power and Ethernet cables.

The detector control unit has to be connected point-to-point to the detector via 1 x LC/UPC duplex connectors. The detector control unit can be integrated into the site network infrastructure using one of the interfaces described in table 4.3. The detector control unit is optimized for performance and stability of operation. In order to achieve these goals we deliver the detector control unit with fixed firmware (BIOS etc.) and software (OS) version. The detector control unit must not be operated in an environment where unauthorized access is possible. The detector control unit does not provide authentication mechanisms and is not protected against malicious acts by unauthorized third parties.

Using the web front end, it is possible to restart the EIGER2 control service, trigger an update, and to shut down and to reboot the detector control unit. Any further control of the detector is carried out via the SIMPLON API (see separate documentation).



**Figure 4.4:** Front view of detector control unit.

Caution
#12



Pushing the power button on the front panel longer than 2 seconds will immediately halt the detector control unit. All image data on the detector control unit will be permanently lost.

Information
#6



Briefly pushing the power button on the front panel will shut down the detector control unit. May take up to 1 min.

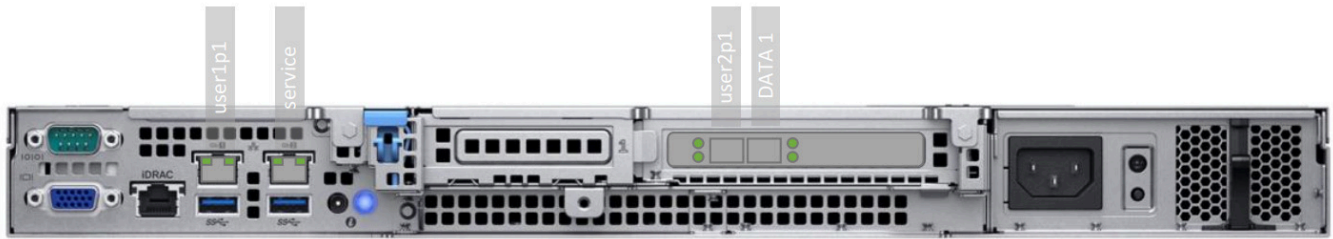

**Figure 4.5:** Back view of detector control unit with network interfaces.

## 4.2.2. Connectors

**Table 4.3:** Detector Control Unit Connectors

Connector	Description
user1p1 (Embedded)	Interface Name: user1p1 (1 GBase-T) User configurable GbE Network Interface Preconfiguration: DHCP
service (Embedded)	Interface Name: service (1 GBase-T) Fallback GbE Network Interface Preconfiguration: Static 169.254.254.1 (Netmask 255.255.255.0)
user2p1	Interface Name: user2p1 (10 Gb SFP+) User configurable SFP+ Network Interface Preconfiguration: DHCP
DATA	Detector Interface Port1
Power	AC Connector

See DELL owner's manual for further details.

## 4.3. Thermal Stabilization Unit

A thermal stabilization unit is required for the operation of the EIGER2 R CdTe 1M detector system.







The hoses and the detector are equipped with self-sealing valves to avoid dripping when connecting or disconnecting the tubes.

The tubing should be kept as short as possible to ensure the best flow.

**Table 4.4:** Operating Conditions

Condition	Definition
Operating temperature	The thermal stabilization unit has to be set to a temperature of 25 °C for normal operation.
Maximum operating pressure	3 bar

**Table 4.4:** Operating Conditions - continued

Condition	Definition
Coolant	Use 66% distilled water and 34% ethylene glycol.
<b>Danger #2</b>	
 Ethylene glycol can be seriously harmful to your health or fatal if handled incorrectly. Consider the packaging and safety instructions provided by your local supplier.	
<b>Information #7</b>	
 Before operating the thermal stabilization unit, please read the User Manual of the thermal stabilization unit.	
<b>Caution #13</b>	
 When connecting or disconnecting the cooling hoses, turn off the detector and the thermal stabilization unit.	
<b>Caution #14</b>	
 When operating the detector, the thermal stabilization unit must always be turned on and the pump has to be activated (see user documentation of thermal stabilization unit).	
<b>Caution #15</b>	
 Use opaque hoses to avoid the growth of algae.	
<b>Caution #16</b>	
 Do not set the temperature of the thermal stabilization unit below the recommended operating temperature. Condensing moisture can develop and damage the detector.	

### 4.3.1. In-Vacuum Operation

Vacuum compatibility can be provided as an option. For in-vacuum operation unscrew the self-sealing valves from the detector and use vacuum-compatible fittings and o-rings. The water connectors use an 1/8 inch ISO parallel thread. Before opening the cooling circuit always remove the coolant to avoid dripping.

**Table 4.5:** In-Vacuum Operating Conditions

<b>Condition</b>	<b>Definition</b>
Operating temperature	Before and during pumping down and venting the thermal stabilization unit has to be set to a temperature of 25 °C for at least 30 min. Prior to powering up and operating the detector in-vacuum the thermal stabilization unit has to be set to a temperature of 19 °C for at least 30 min.

---

## 5. INSTALLING THE DETECTOR SYSTEM

### 5.1. Transport Considerations

Warning

#2



Avoid vibration and shock when moving the detector.

The detector has been delivered in a robust transport box. Please keep this transport box for transport or storage purpose.

### 5.2. Mounting

The detector can be mounted in the ways which are described below.

#### 5.2.1. Mounting from Below

Warning

#3



It is strictly forbidden to add any threads to the detector base plate or to the detector housing.

The detector should be mounted using the four internal M6x1 threads as shown in figure 5.1 (indicated with yellow circles).

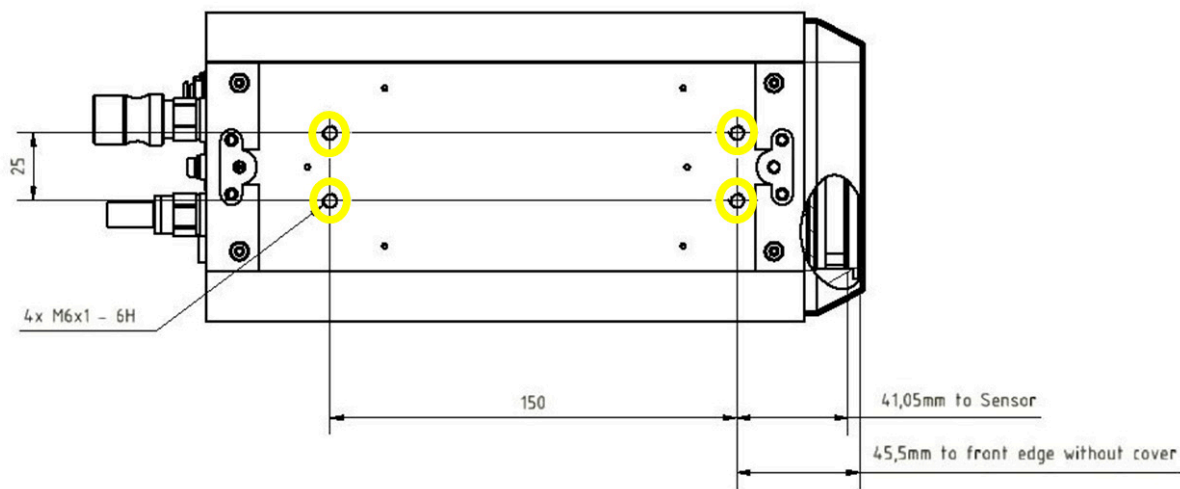

**Figure 5.1:** Drawing of the EIGER2 R CdTe 1M Detector Base Plate (also printed separately in the user documentation folder)

Caution

#17



The four M6 screws must not intrude into the detector more than 10 mm.

### 5.2.2. Mounting from Above

Use the mounting brackets (optionally available) as depicted in figure 5.2. These mounting brackets have to be mounted on the base plate of the detector. The detector should be mounted using all four outer 7 mm holes (indicated with yellow circles).

Caution

#18



Make sure the mounting brackets are mounted and properly tightened using the screws provided. The placement of the screws is indicated with diamonds in figure 5.2.

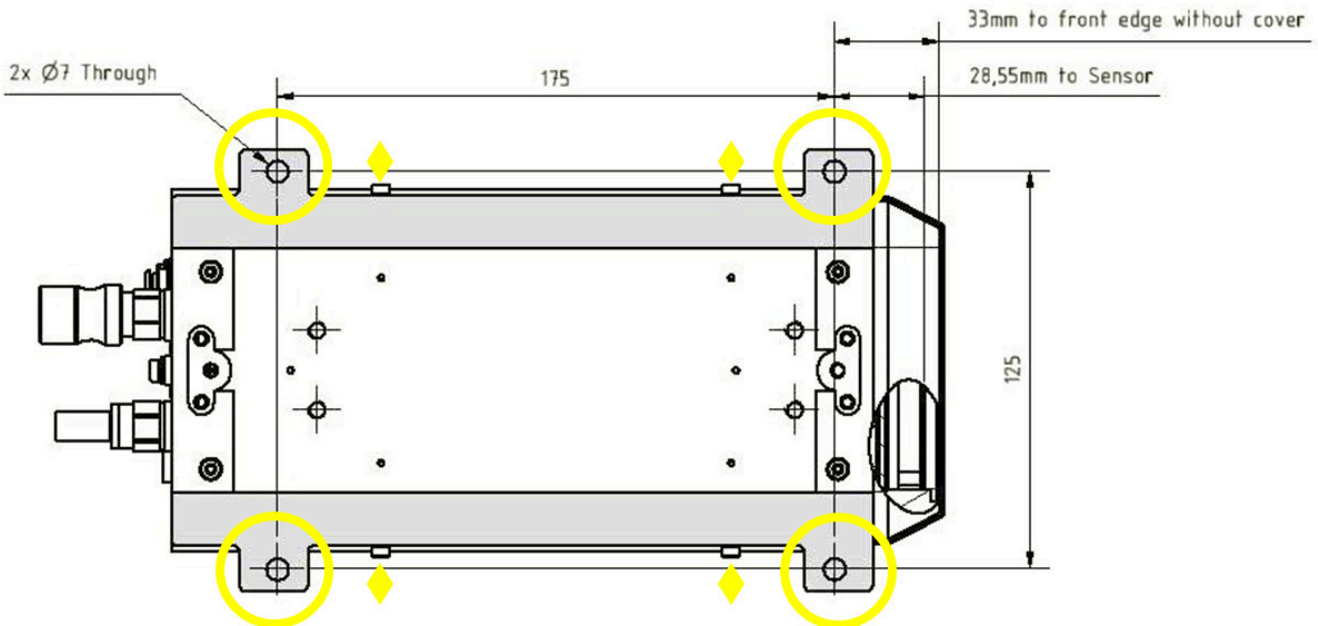

**Figure 5.2:** Drawing of the EIGER2 R CdTe 1M Detector Base Plate with Mounting Brackets (bottom view)

### 5.3. Grounding of the Detector

Caution

#19



The main plug of the detector control unit has to be connected to a grounded power outlet.

Although the detector might be already grounded via the mounting bolts, the detector should be grounded additionally via the functional ground connector at the top in order to establish a defined grounding. Although the detector might be already grounded via the mounting bolts, the detector should be grounded additionally via the functional ground connector at the back in order to establish a defined grounding.

### 5.4. Connection to Dry Air or Nitrogen

Warning

#4



When venting with nitrogen, take proper precaution against the risk of asphyxiation caused by oxygen displacement from nitrogen. Ensure sufficient ventilation and oxygen level monitoring. Use compressed air for venting large vessels or in confined spaces.

Caution

#20



Humidity might damage the detector. Make sure that the detector is operated within the allowed ambient conditions (see section 3.3).

The EIGER2 R CdTe 1M detector has to be connected to a dry air (or nitrogen) source to avoid humidity and condensation damage when it is outside of the storage box. For information on system connections, refer to the section 4.1.5 and for storage of the detector system refer to the section 7.5.

Information

#8



Oil free, dry air of <20 % relative humidity or nitrogen must be used.

- The recommended flow is 5 l h<sup>-1</sup> to 10 l h<sup>-1</sup> (at 2 bar).
- For reliable operation we recommend dry air of <5 % relative humidity.
- The gas pressure must not exceed 2 bar.
- The minimum gas pressure is 1 bar.
- The humidity control shuts down the power of the detector modules when the humidity is too high (see chapter 6).

An external valve is supplied together with the system to regulate the dry air flow (see figure 5.3). Regulate the airflow according to the information above.



**Figure 5.3:** External dry air valve

### 5.4.1. In-Vacuum Use

Caution

#21



The temperature and humidity control cannot prevent condensation issues and resulting damage to the sensor due to improper use. Always make sure that the detector is warmed up (thermal stabilization unit temperature set to 25 °C) prior to pumping down, venting, and opening the chamber. Only use dry air or nitrogen for venting.

For in-vacuum operation no nitrogen or dry air flow is necessary. Refer to section 7.4 for more information.

## 5.5. Connection to Thermal Stabilization Unit

Caution

#22



- Use only the included thermal stabilization unit.
- Use only the supplied hose couplings.

The EIGER2 R CdTe 1M detector is water-cooled and must be connected to a dedicated thermal stabilization unit. The detector is supplied with quick coupling connectors to connect the cooling tubes to the thermal stabilization unit. An optional 90° mounting piece can also be supplied.

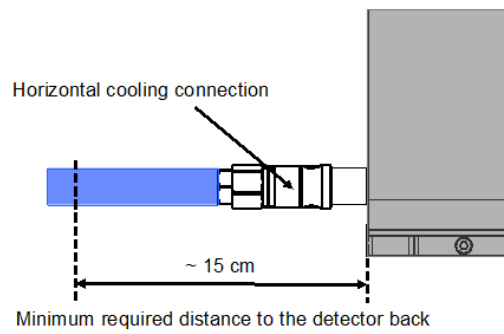

**Figure 5.4:** Horizontal coolant connectors

## 5.6. Mounting the Detector Control Unit

Caution

#23



Make sure that the detector control unit has adequate ventilation.

The detector control unit can be mounted in a standard 19 inch rack, which has to be properly grounded.



## 6. TEMPERATURE AND HUMIDITY CONTROL

The EIGER2 R CdTe 1M detector has a combined temperature and humidity sensor.

The temperature and humidity control shuts down the detector when the humidity or the temperature of the sensor exceeds the following limits:

**Table 6.1:** Temperature and Humidity Limits

Shutdown Temperature	Shutdown Humidity
15 °C	35 °C
	40 % at operation / 40 % at start-up

The communication with the detector control unit will remain active after a temperature shut down (only power of the modules shuts down).

### Warning

#5



The temperature and humidity control cannot prevent condensation issues and resulting damage to the sensor due to improper use. Always make sure that the detector is set to the correct temperature (thermal stabilization unit temperature set to 25 °C).

### Information

#9



The detector has an internal thermal protection switch. If the thermal protection switch is activated, it turns the detector off to prevent damage. In this case all LEDs will be off and no communication is possible any more with the detector.

### Information

#10



If the humidity is outside the specified range, the software will prevent operation. The user can check the temperature and humidity via the API, as long as the temperature is not out of range. If the temperature breaches safe conditions the thermal protection switch will be triggered and the detector will completely switch off.

To start the detector correctly, please refer to section 7.1 and execute the correct startup procedure.

Make sure that the cooling unit is running at the recommended temperature (according to section 4.3) and that Nitrogen or dry air flow is turned on at the recommended flow rate, given in section 5.4. Then restart the software.

### Information

#11



A free-flowing air stream is mandatory in order to properly cool the electronics inside the detector. Do not cover any ventilation holes.

## 7. OPERATION PROCEDURE

Before operating the detector, make sure you have read the Technical Specifications and the User Manual.

### 7.1. Getting Started

Before switching on:

- Mount the detector properly.
- Connect the detector to ground potential, using the functional ground connector.
- Connect the detector to power supply.
- Connect the detector to a nitrogen or dry air source, capable of supplying at least the minimum recommended flow rate.
- Connect the coolant hoses. Make sure they are properly mounted on both sides.
- Set the temperature to 25 °C on the thermal stabilization unit and turn it on. If the detector was not at room temperature, wait until the thermal stabilization unit has reached stable operation.
- Connect the power cable, the local network cable, and the detector data cable to the detector control unit. (If more than one data cable is required, please pay attention to the numbering of the cables as described in table 4.2)

### 7.2. Startup Procedure

Please use the following startup procedure:

- Turn on the dry air or nitrogen at least 30 min before turning on the detector.
- Push the standby button at the back of the detector into its depressed position.
- Turn on the detector control unit. Wait at least 5 min before trying to connect.
- Initialize the detector and wait at least 15–30 min for the detector bias voltage to stabilize.

The detector is now ready to use.

Information

#12



The software start-up procedure is described in detail in the User Manual.

### 7.3. Turning Off the Detector

To turn off the detector:

- Turn OFF the detector control unit.
- Do not remove the nitrogen/dry air connection. It is a requirement that it is left at the recommended flow rate according to section 5.4.

Warning

#6



As long as the detector power cable is connected, the detector has to be considered under power.

## 7.4. Vacuum Operation

DECTRIS detectors can be provided for vacuum operation. The typical reachable vacuum is  $10^{-3}$  mbar (read-out electronics in vacuum) or  $10^{-6}$  mbar (only detector head in vacuum). The outgassing rate and content are not specified. The vacuum compatibility option guarantees that the detector will operate in the mentioned vacuum range. Detectors ordered with a vacuum compatibility option have been tested in vacuum.

To see if a detector is vacuum compatible, check whether the vacuum compatibility option is included in the order confirmation received from DECTRIS.

### 7.4.1. Ambient Conditions for In-Vacuum Use

Warning #7



Only systems with a vacuum compatibility option are allowed to be operated in vacuum.

For in-vacuum operation of the detector following conditions must be fulfilled:

**Table 7.1:** In-Vacuum Operating Conditions

In-Vacuum Condition	Definition
Pressure during operation	atmospheric pressure or less than 0.01 mbar <div style="display: flex; align-items: center; margin-top: 5px;"> <div style="text-align: center; margin-right: 10px;">1 bar</div> <div style="text-align: center; margin-right: 10px;"><math>10^{-2}</math> mbar</div> <div style="flex-grow: 1; position: relative;"> <div style="background-color: #c00000; width: 100%; height: 10px; position: absolute; top: 0;"></div> <div style="background-color: #0056b3; width: 100%; height: 10px; position: absolute; top: 10px;"></div> <div style="position: absolute; top: 0; left: 0; width: 100%; height: 100%; background: repeating-linear-gradient(45deg, transparent, transparent 2px, #ccc 2px, #ccc 4px); background-size: 10px 10px;"></div> </div> <div style="margin-left: 10px;">...</div> </div> <div style="display: flex; justify-content: space-between; margin-top: 5px; font-size: small;"> <span><math>10^5</math> Pa</span> <span>1 Pa</span> </div>
Detector mounting plate temperature during operation	10 °C to 25 °C
Thermal stabilization unit set temperature in vacuum	19 °C
Chamber temperature during "bake-out" (detector unpowered)	max. +60 °C (for temperatures > 40 °C make sure the thermal stabilization unit is set to +40 °C and running)

### 7.4.2. Operation Procedure In-Vacuum

Make sure the vacuum conditions in table 7.1 are met and follow below procedures for venting and pumping down the vacuum chamber.

Warning #8



Prior to pumping down (and venting):  
Always make sure the detector has NO POWER and is WARMED UP to room temperature. Otherwise it could be damaged through electrical discharge or condensation.

## Pumping Down the Vacuum Chamber

- Mount the detector properly inside the vacuum chamber.
- Connect the detector power, data, trigger, and coolant lines inside and outside the vacuum chamber.
- Connect the detector control unit and the detector data cables.
- Make sure the standby button on the back of the detector is in its depressed state.
- Make sure the detector is POWERED OFF, either by disconnecting the power supply outside the vacuum chamber or by switching OFF the detector power supply (i.e. the detector can be powered up later from outside the vacuum chamber).
- Close the vacuum chamber and start to pump down.
- Once the pressure inside the vacuum chamber is below  $1 \times 10^{-2}$  mbar set the temperature on the thermal stabilization unit to 19 °C and turn on the thermal stabilization unit (pumping down a warm detector prevents condensation issues).
- After the thermal stabilization unit has reached the set value and the pressure inside the vacuum chamber is sufficiently low to meet the operating conditions, power up the detector.

## Venting the Vacuum Chamber

- Turn OFF the power to the detector, either by disconnecting the power supply outside the vacuum chamber or by switching OFF the detector power supply.
- Set the temperature to 25 °C on the thermal stabilization unit and let the detector warm up at least 30 min to prevent condensation inside the vacuum chamber.
- Use dry air or nitrogen to vent the chamber.

## 7.5. Storing the Detector

Information

#13



Even if the detector is not in operation, it is recommended that the dry air or nitrogen flow is maintained to reduce the risk of humidity damage to the detector.

Please follow these instructions:

- Put the detector in a plastic bag, add at least 200 g of drying agent (i.e. silica gel) into the bag and seal it air-tight.
- Check the humidity and change the drying agent frequently for compliance with the storage requirements in section 3.3.

## 7.6. Cleaning and Maintenance

Caution

#24



The Mylar® foil must not be touched or cleaned. If it is damaged, please contact DECTRIS technical support.

The housing can be cleaned with a soft tissue.

The EIGER2 R CdTe 1M detector does not require any maintenance.

Please refer to the user documentation of the thermal stabilization unit for detailed information about the maintenance of your thermal stabilization unit.

## 8. SAFETY INSTRUCTIONS FOR CDTE SENSORS

The sensor material is built up from Cadmium Telluride (CdTe). In order to prevent injuries, please follow these safety precautions.

Warning

#9



- Do not inhale Cadmium Telluride (CdTe) dust when sensor is broken or burnt.
- Do not ingest Cadmium Telluride (CdTe).
- Avoid skin contact.

For recycling, see section 2.1.

## 9. TROUBLESHOOTING

table 9.1 provides an overview of possible problems with the detector system and instructions in order to solve the problems. If the problem you are experiencing is not listed below or if the instructions do not help, please contact support@dectris.com.

The LEDs at the back of the detector can provide valuable information for troubleshooting. Check section 4.1.4 for further informations.

**Table 9.1:** Troubleshooting

<b>Problem</b>	<b>Cause</b>	<b>Solution</b>
Detector control unit does not start properly.	Detector control unit is not powered.	Check the User Documentation of the detector control unit (see section 3.2.3).
Communication error, the detector is not found at startup.	Data cable is not connected or defective.	<p>Check the connection between detector control unit and detector. Make sure that there is a direct, peer-to-peer connection between the detector control unit and the detector.</p> <p>Avoid tangling or strong bending of the Ethernet data cable.</p> <p>Check the status of the LINK LED. If the detector control unit and the detector are powered and correctly connected, the LINK LED should be green (Takes up to 30s after power up).</p>
Detector shuts down.	Temperature or humidity error.	<p>Check that the detector is properly supplied with coolant and check the temperature of the coolant at the front panel of the thermal stabilization unit.</p> <p>Check the flow of nitrogen or dry air.</p> <p>Check the temperature of the detector using the SIMPLON API and wait until the detector cools down.</p> <p>Restart the detector again.</p>
The detector fails to turn on.	The power cord is not connected or the plug is incompletely inserted.	Connect the power cord firmly. Check the LED on the external power supply.
	The temperature is over the critical limit. The thermal protection was triggered.	Check the thermal stabilization unit. The detector will power on again, as soon as the temperature is within the allowed operating conditions.
Image acquisition not possible.	Detector is not properly initialized.	Initialise the detector via the SIMPLON API. (See API Reference)

**Table 9.1:** Troubleshooting - continued

<b>Problem</b>	<b>Cause</b>	<b>Solution</b>
Detector housing is humid.	Ambient humidity around the detector exceeds the operating conditions.	Shut down the detector immediately and check the humidity. Power up the detector only when the ambient humidity has been reduced.

---