

Standard systems

HiClave™ systems are built up in a modular manner. The components described below form the basis for versatile pressure reaction systems. They can be adjusted to suit the demands in each case and upgraded with the aid of the auxiliary modules and components.

10 ml and 20 ml reactors



10 ml and 20 ml reactors have a cover with a union nut and a central media connection with a crosspiece. The centre connection of the crosspiece is occupied by the interior temperature controller, those at the side normally with the media connection and manometer.

The reactors are tempered using a magnetic heating stirrer with a heating block and stirred using a magnetic stirring rod.

Equipment

- › Simple heating and stirring using a magnetic heating stirrer with a heating block attachment.
- › Temperature controller (Pt100)

Possible connections

- › 1 x temperature controller
- › 1 x pressure display
- › 1 x media connection

Options

- › Other connection allocations

50 ml reactor



The reactors are heated using a heating sleeve and stirred from above. In such a case cooling may be carried out using a cooling plate. Alternatively, heating and stirring takes place using a magnetic heating stirrer and a heating block.

The 50 ml reactor has a cover with a union nut and 3 connections. One of these can be fitted with a magnet-coupled stirrer drive. The stirrer runs eccentrically.

The two other connections are used for the thermal controller and media supply. If a magnetic stirrer is preferred to a stirrer drive, the connection which is thus freed may be used as desired.

Equipment

- › Heating via a heating sleeve
- › Stirring using a magnetic stirrer head
- › Temperature controller (Pt100)

Connection pieces

- › 1 x temperature controller
- › 1 x overhead stirrer, alternatively free
- › 1 x media connection

Options

- › Cooling plate for controlled cooling
- › Other connection allocations
- › A heating block or heating sleeve

Product code	Description
HA-HICLAVE-SC-n	Frame for HiClave™ pressure reactors, tubing, cabling, pressure sensors
HA-HICLAVE-ws-vol-p	HiClave™ pressure reactor, manometer, Pt100 temperature sensor, rupture disk
HA-HICLAVE-HEABAN-250	Heating sleeve for reactors < 250 ml, 230 V AC 700 W, double temperature sensor, thermal protector
HA-HICLAVE-HEABAN-50	Heating sleeve for reactors < 50 ml, 230 V AC 320 W, double temperature sensor, thermal protector
HA-HICLAVE-COOLP	Cooling plate for mains water or thermostat connection, with 24 V solenoid valve
HA-HICLAVE-STIRR-40-rf	Magnet-coupled overhead stirrer, 40 Ncm with a drive
HA-HICLAVE-STIRR-80-rf	Magnet-coupled overhead stirrer, 80 Ncm with a drive
HA-HICLAVE-RPMMON	Rotation speed monitor on the stirring shaft, NAMUR level
HA-HICLAVE-MAGHEAT	Magnetic stirrer with heating plate
HA-HICLAVE-HYDR	Hydration and gas injection module for HiClave™ pressure reactors with a mass flow controller
HA-HICLAVE-GRAV1150	150 ml gravimetric dosing unit for HiClave™ pressure reactors
HA-HICLAVE-ABKPNK1	Automation unit with an operator station and SL-LABVIPEASY software package 100 DP, for one HiClave™ unit with gravimetric dosing, temperature control, hydration
HA-HICLAVE-ABKPNK2	Automation unit with an operator station and SL-LABVIPEASY software package 180 DP, for two HiClave™ units, each with gravimetric dosing, temperature control, hydration
HA-HICLAVE-ABKPNK4	Automation unit with an operator station and SL-LABVIPEASY software package 300 DP, for four HiClave™ units, each with gravimetric dosing, temperature control, hydration

n (= Number of reactors): 1 to 8

ws (= material): Stainless steel 1.4571 (SS 316Ti); e, Hastelloy® C4; h, special material: s

vol (=working capacity): 10, 20, 50, 100, 150, 250 equivalent to 10, 20, 50, 100, 150 or 250 ml

p (=working pressure): 100, 200, 300 equivalent to 100, 200, 300 bar (350 and 400 bar on request)

rf (=stirrer shape): br, pr, an equivalent to stirring paddle, propeller stirrer, anchor stirrer

Special designs, such as for other capacities, connections, materials etc. are available on request.



JUCHHEIM
Laborgeräte GmbH

HiClave™

High Pressure Stirred Autoclaves

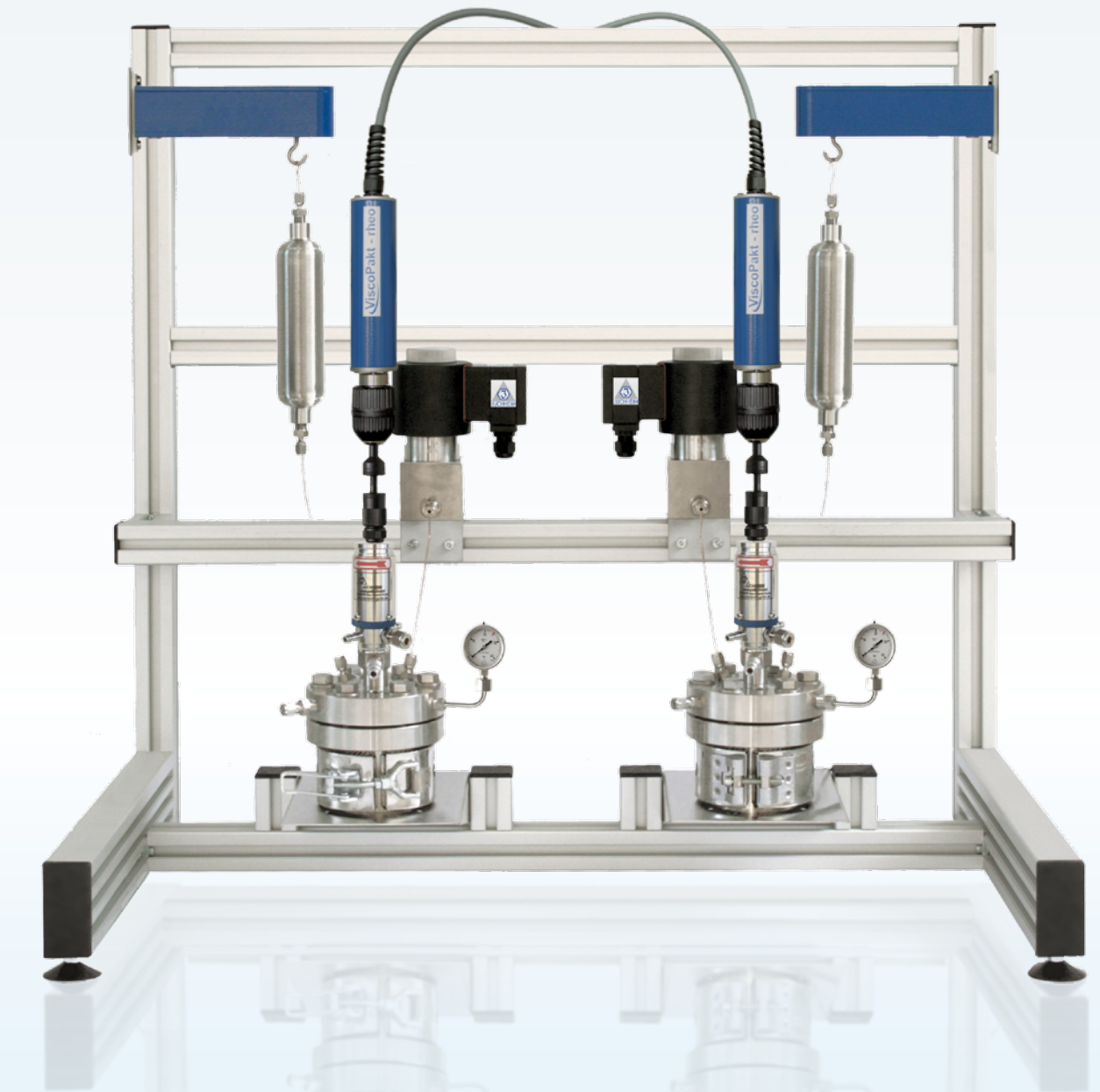

JUCHHEIM Laborgeräte GmbH
Handwerkstr. 3-7
54470 Bernkastel-Kues
Germany

Tel.: +49 (0)6531 / 964 - 400
Fax: +49 (0)6531 / 964 - 415

info@juchheim-gmbh.com
www.juchheim-gmbh.com

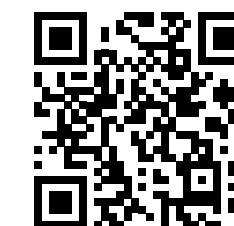

HiClave™ - High Pressure Stirred Autoclaves

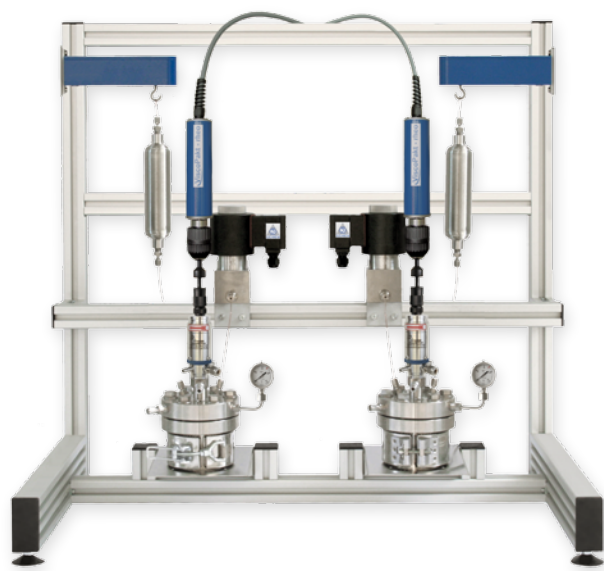

HiClave™ high-pressure reactor systems are a proven solution for high-pressure reactions, especially on multi-phase systems.

They may be supplied in a volume range of 10 to 250 ml (optionally higher volumes), with a maximum pressure of up to 300 bar (optionally 400 bar) and a maximum temperature of up to 300 °C (optionally 400 °C). Thanks to the pure metallic pressure cap seal, the system achieves a tightness which enables highly accurate measurements of gas consumption. The cover can be equipped with up to 7 media connections, sensors etc.

For reactors of 100 -ml content and larger the connections may be partially or fully routed around the outside of the cover flange.

This enables better handling and creates more space for peripherals. Various heating/cooling systems, magnetic stirrers or magnet-coupled overhead stirrers, as well as volumetric and gravimetric gas and liquid supply systems are available.

HiClave™ systems may be operated as single and parallel reactor systems. In addition to the standard configurations, customized systems can also be manufactured to meet customer requirements.

The advantages

- » **Metal sealing (without sealing ring)**
- » **Open, expandable system**
- » **Easy to clean (Ra < 0,8 µm)**
- » **Cooling option**

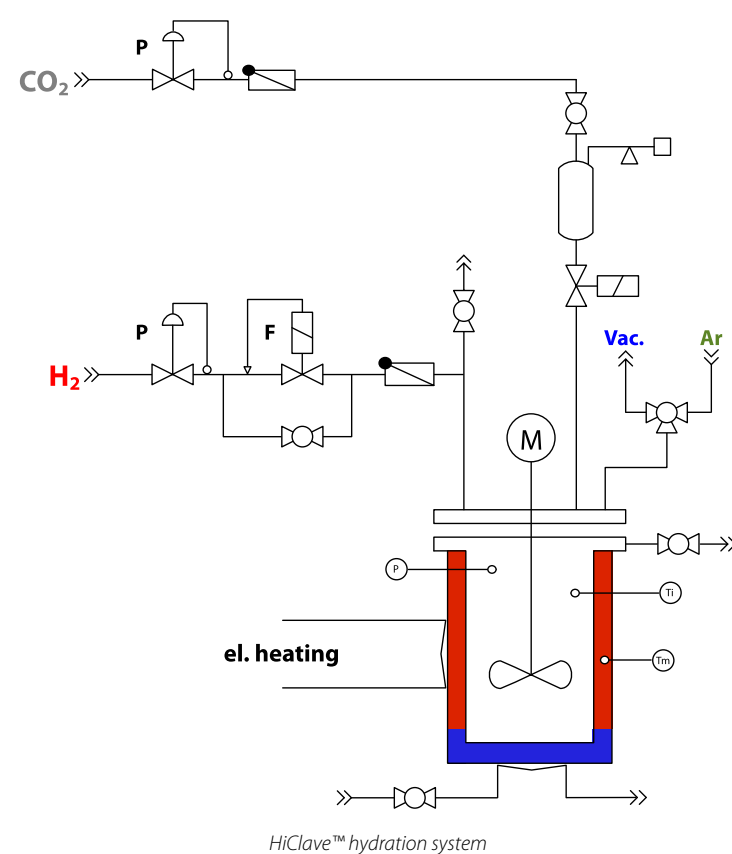

HiClave™ hydration system

HiClave™ - High Pressure Stirred Autoclaves are suited for the following processes

- » Hydrogenation
- » Oxidation
- » Carbonylation
- » Polymerization
- » And many more

100...250 ml reactors



The 100 ml to 250 ml reactors have a flange cover which is screwed down using expansion screws with 7 connections. Three of these connections have been moved to the outer side of the cover so that they may be better reached. The central connecting piece is occupied by the magnet-coupled stirring head. The reactor may be manufactured in stainless steel 1.4571 (SS 316TI) or Hastelloy®.

The reactors are heated using a heating sleeve and can be cooled either via a cooling plate or an internal cooling loop. Stirring takes place using a magnetic stirrer head, optionally with a maximum torque of 40 Ncm or 80 Ncm. The appropriate fitting kits may be supplied either in stainless steel 1.4571 (SS 316TI) or in Hastelloy® C4.

Equipment

- » Heating via an electric heating sleeve
- » Stirring using a magnetic stirrer head
- » Temperature controller (Pt100)

Connection pieces

- » 1x stirring shaft
- » 1 x immersion pipe for temperature controller
- » 1 x metal rupture disk for safe limitation of the maximum pressure
- » 1 x pressure display
- » 1 x valve for pressure relief
- » 2 x freely allocatable, e.g. for a gas sampling valve or liquid sampling

Options

- » Hydration/gas injection module
- » Liquid and/or gas sampling
- » Cooling via a cooling plate or a cooling loop
- » Hastelloy® finish and other special alloys

Hydration module

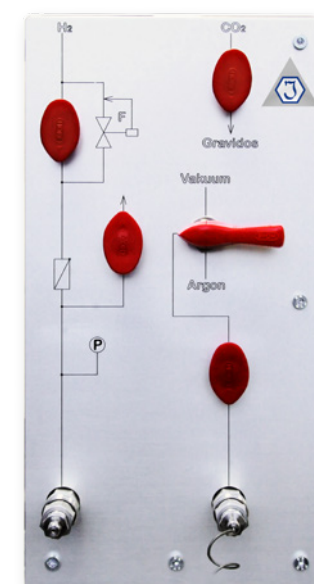

Operating panel of a HiClave™ hydrogenation unit

The HA-HICLAVE-HYDR hydration module enables a complete hydration process to be carried out including inert gas rinsing and leak testing of the reactor without any manual intervention. As a result, no-one has to be present in the high-risk area during the time in which the reactor is under pressure. For this, inert gas is applied to the reactor up to an adjustable pressure and then aerated. This rinsing cycle may be repeated as often as desired. Subsequently, a pressure check with inert gas is performed. The duration of the check and the tolerance for passing the test are freely selectable.

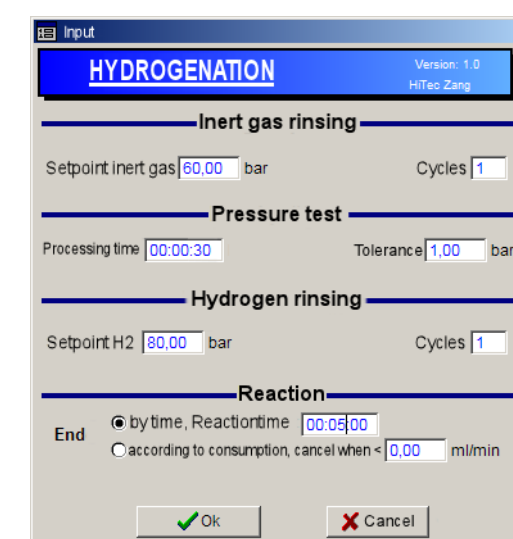

Parameter mask for pressure reactions

Only if the pressure test has been passed the reaction gas – in the above example hydrogen – is released, otherwise the reactor is aerated. Then, rinsing is made with the reaction gas, the set pressure is reached and the process started.

A gas consumption measurement unit for the recording of kinetic data is integrated. The gas consumption may also be used as a criterion for aborting, meaning that the reaction will be aborted if consumption has fallen below a given rate.

The system is monitored and operated using a generally self-explanatory user interface.

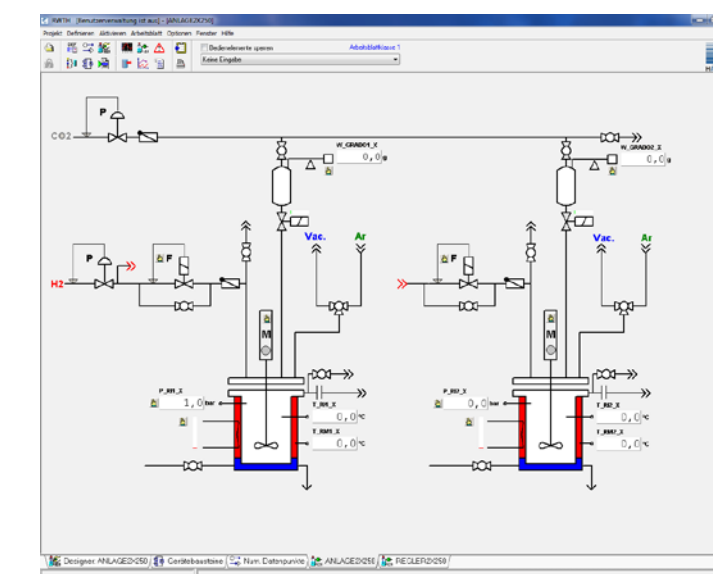

LabVision® user interface

The measured data are automatically recorded and listed in a report. If a gas consumption measurement has been carried out, a kinetic analysis of the consumption curve may also be performed.

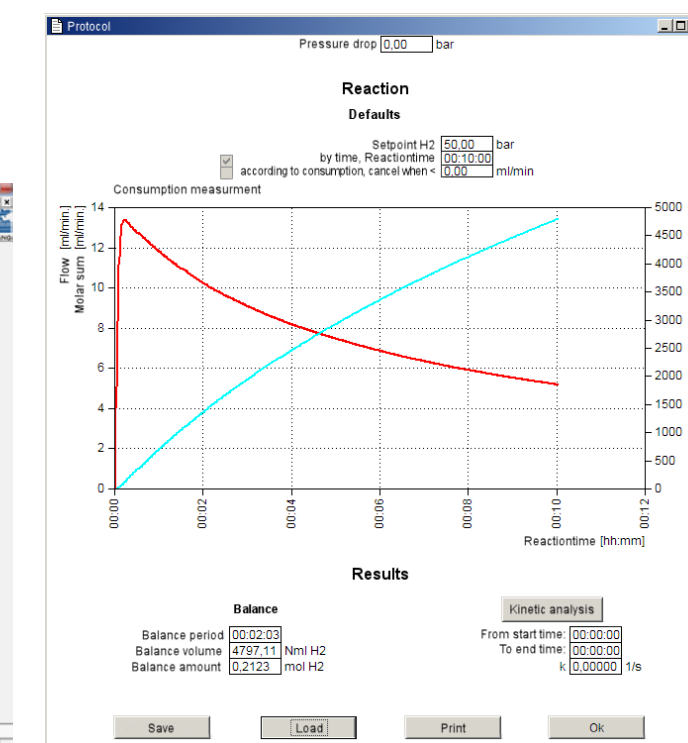

Report of a pressure reaction, analysis in accordance with pseudo-first-order kinetics

Design

Frame	Square anodised aluminium profile, stainless steel platform for the reactor
Reactor	10...250 ml stainless steel reactor (optionally in Hastelloy), 350 bar (optionally 400 bar), 350 °C (optionally 400 °C), Ra < 0,8 µm, rupture disk
Stirrer	Stirrer with magnetic coupling, speed 200...1.500 rpm, maximum torque 40/80 Ncm, including an analogue interface for the speed control (reactors ≥ 50 ml), or: Magnetic heating stirrer with a heating block and magnetic stirring rod (Reactors ≤ 50 ml) Available stirring blades: Paddle stirrer, propeller stirrer, anchor stirrer and more on request.
Heating/cooling system	Heating sleeve/cooling plate (alternatively a cooling loop), working temperature range 40...350 °C (optionally 400 °C) in the jacket, heating power up to 700 W, Alternatively: magnetic heating stirrer with a heating block attachment
Sampling	Manually using a sampling valve
Gas injection	Reaction gas under pressure regulation via MFC, including gas consumption measurement, by-pass valve
Inerting	Inert gas under pressure regulation, exhaust gas via a high-pressure solenoid valve
Liquid dosing system	GraviDos® high-pressure dosing system up to 400 bar, alternatively/optionally a high-pressure pump
Sensors	Reactor interior temperature, jacket temperature, reactor interior pressure, speed, ATR-FTIR Example of two stirred autoclaves: HiTec Zang LabManager® 2 with the following equipment: 4 Pt100 temperature measurement inputs, 4 analogue inputs (current and voltage), 4 RS232 interfaces (stirrer, hydration modules), 4 GraviDos® connections, 8 digital outputs 2 safety temperature controllers
Automation	HiTec Zang OS, TFT monitor, uninterrupted power supply, HiTec Zang LabVision® software package with project module library and EasyBatch™. This automation system can monitor 2 reactors, an expansion to 4 reactors is possible
Materials	Product contacting materials: Stainless steel 1.4571, other types of stainless steel, Hastelloy®