

## ***SONOPULS***

### Ultrasonic homogenisers



Ultrasonic homogeniser HD 2070.2

valid for:

HD 2070.2	Volumes:	1 ml - 200 ml
HD 2200.2	Volumes:	2 ml - 1000 ml

#### Copyright and disclaimer

This document may not be reproduced, whether in full or in part, without the prior approval of BANDELIN electronic GmbH & Co. KG, hereinafter "BANDELIN".

The German-language original is the binding version of this document. Any differences in the translation are not binding and have no legal effect. In case of any discrepancies between the translation and the original of this document, the original version will take precedence.

BANDELIN accepts no responsibility or liability for damage caused by improper handling or usage contrary to the intended purpose.

The documentation has been prepared with great care. All liability is excluded for any direct or indirect losses resulting from incomplete or erroneous information contained in this documentation, or in its presentation or usage.

All images are provided as examples and are not true to size. Decorative elements are not included in the scope of delivery.

Subject to technical changes. Measurements are subject to manufacturing tolerances.

© 2020

**BANDELIN electronic** GmbH & Co. KG, Heinrichstrasse 3 – 4, Germany, 12207 Berlin,

Tel.: +49-30-768 80 - 0, Fax: +49-30-773 46 99, [info@bandelin.com](mailto:info@bandelin.com)

## General information

The equipment, the accessories and the preparations are to be used in accordance with the user instructions and/or the product information.

The instructions are part of the scope of delivery and are to be stored in the vicinity of the device for later reference. This also applies if possession of the device is transferred elsewhere.











Before the device is put into operation, these instructions are to be read carefully and completely in order for the user to become familiarised with all functions.

The warnings and safety precautions (Chapter 1.5) are always to be followed during use.

The manufacturer will not assume any responsibility for the device's safety or functional ability in the event of improper handling or usage contrary to the intended purpose. In the event of unauthorised alterations/modifications, both the warranty claim and the CE conformity will expire.

If service is required, please contact the authorised dealer or the manufacturer.

### Symbols used:

Symbol	Meaning	Explanation
	Danger	Used to mark information that, if not observed, could constitute a risk to life and limb, especially as a result of electric shock.
	Caution	Used to mark information that must be observed and complied with in order to avoid damage to the device or injury to the user.
	Warning	Warning of hot surface.
	Important	Identifies information that is important for implementation.
	Note	Used to mark explanatory information.
	In vitro diagnostics information	Identifies information that is important for in vitro diagnostics applications.
	Medical note	Identifies information that is important for medical use.
	Do not grip inside	For health reasons, touching the oscillating fluid is prohibited.
	Wear ear protectors	For health reasons, spending long periods of time in the vicinity of the device without ear protectors is prohibited.
	Instructions	Identifies instructions that must be followed in the described sequence.

# Table of Contents

1	Product description .....	6
1.1	Basic working principle .....	7
1.2	Intended purpose .....	7
1.3	CE conformity .....	7
1.4	Technical data .....	8
1.4.1	Ultrasonic generator (GM) .....	8
1.4.2	Technical data, ultrasonic transducers .....	10
1.4.3	Remote operation .....	10
1.4.4	Electromagnetic compatibility (EMC) .....	11
1.5	Warnings and safety precautions .....	12
2	Preparation .....	14
2.1	Scope of delivery .....	14
2.2	Set-up / assembly .....	14
2.3	Start-up .....	15
3	Operation .....	15
3.1	Operating controls .....	15
3.1.1	Turning the homogeniser on/off .....	16
3.1.2	Explanation of the display fields .....	16
3.2	Setting the operating parameters .....	16
3.2.1	Sonication time [time] .....	17
3.2.2	Pulsation [pulse] .....	18
3.2.3	Special functions .....	19
3.3	Activating / deactivating the ultrasound .....	20
4	Usage .....	21
4.1	Instructions for use .....	21
4.2	General use .....	21
4.3	Selecting a suitable probe .....	23
4.3.1	Mounting and dismounting of the probes .....	24
4.3.1.1	Mounting and dismounting the titanium plates .....	25
4.3.1.2	Mounting and dismounting of micro and tapered tips and long probes .....	26
4.4	Dismounting and mounting of the standard and booster horns .....	27

5	Cleaning and maintenance of the homogeniser .....	29
5.1	Cleaning and care .....	29
5.2	Treatment of contaminated parts in the ultrasonic transducer, vessels and accessories pertaining to the medical field .....	30
5.3	Positioning / storage .....	30
6	Maintenance and repair .....	31
6.1	Maintenance .....	31
6.2	Functional checks .....	31
6.2.1	Testing the ultrasonic transducer (probe check) – Error 011 .....	31
6.2.2	Conducting a frequency scan (scan frequency) – Error 002/011/012 .....	31
6.3	Troubleshooting .....	33
6.4	Repairs and service .....	35
6.4.1	Decontamination certificate .....	35
7	Accessories .....	36
7.1	Required accessories .....	36
7.2	Optional accessories .....	36
8	Consumable materials .....	37
9	Decommissioning .....	37
10	Keyword index .....	38

## General information

A	Tools for mounting/dismounting
---	--------------------------------

# 1 Product description

The SONOPULS ultrasonic homogeniser is essentially made up of three components: the ultrasound generator, the ultrasonic transducer, and the working tip (probe). The individual components can be varied using a multitude of options and accessories. The type specification and serial number are found on the type plate.

## Product features:

- Ultrasonic generator (1) in easy-care robust metal housing with connection for the ultrasonic transducer.
- Operating and display panel (2) with LCD display (3)
- Ultrasonic transducer (4) with Start/Stop button (4a)
- Standard and/or booster horn (5)
- Probe (6)
- Mains switch (7)

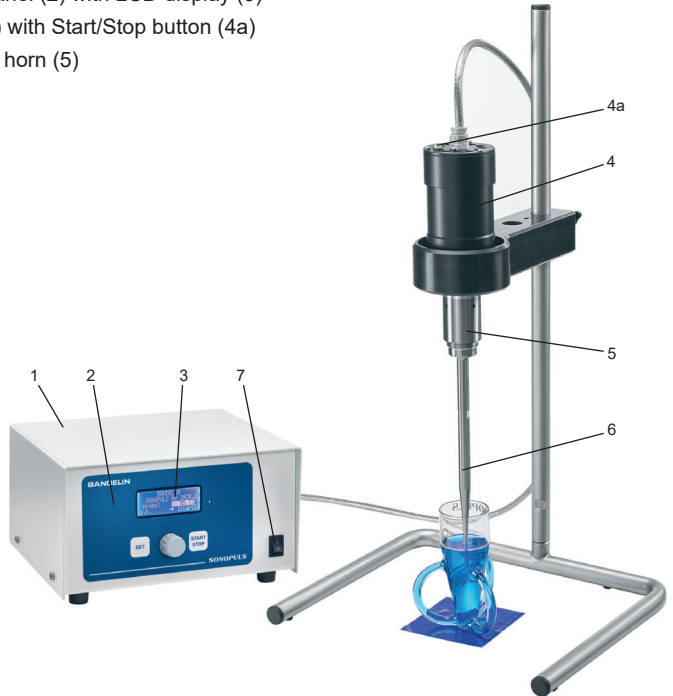

## Product features on the rear of the ultrasonic generator:

- Panel-mounted plug (8) with fuse holder
- Ultrasonic socket (9) and/or ultrasonic transducer
- Remote control connector (10)

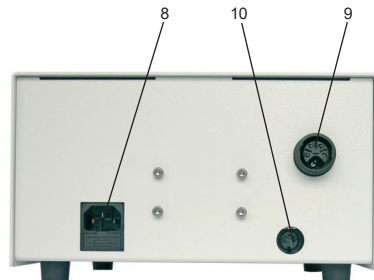

## 1.1 Basic working principle

The ultrasonic generator transforms the mains energy input (mains frequency 50 or 60 Hz) into high-frequency energy with a frequency of 20 kHz. Thanks to the ultrasonic transducer that is connected to the ultrasonic generator, the high-frequency energy of the ultrasonic generator is converted into ultrasonic and thus into mechanical energy. This takes place with an efficient and robust PZT ultrasonic oscillating system. Thus, mechanical deflections with the same frequency of 20 kHz are generated on the tip of the probe and transferred into the sonication medium as ultrasonic waves with a high power intensity. The amplitude is held constant by the ultrasonic transducer (AMPLICHRON® system), independently from the applied load, using a signal feedback as long as the maximum power allowed is not exceeded. Thanks to these measures, the reproducibility of the process parameters is guaranteed and validation of the process is supported.

Standard and/or booster horns with probes (micro tips, tapered tips or titanium plates) are mounted on the ultrasonic transducer. These work as mechanical transformers and enable a multiple mechanical amplification of the ultrasonic amplitude at the tip.

## 1.2 Intended purpose

SONOPULS ultrasonic homogenisers generate high-performance ultrasonic with high intensities and ultrasonic amplitudes, which are transferred into liquid media using working tools called probes. They are used in laboratories, clinics, and in industrial research, and they perform diverse tasks during sample preparation in Quality Assurance, scientific experiments, analyses, and in pilot or short-series manufacture.

### Examples of uses:

- Cell disruption for paternity tests
- Cell disruption (extraction of micro-organisms, tissue cells)
- Homogenising of liquids
- Emulsifying hard-to-mix liquids
- Dispersion of agglomerates
- Acceleration of chemical reactions
- Degassing of fluids
- Sample preparation in environmental analytics (wastewater tests, soil samples)
- Sonochemistry

**IVD**

SONOPULS ultrasonic homogenisers are also used for in-vitro diagnostic lab procedures, to procure information from the handling of organic materials with ultrasound. Therefore, they are classified and treated in accordance with the Directive 98/79/EC on in-vitro diagnostic medical devices.

## 1.3 CE conformity

SONOPULS ultrasonic homogenisers are declared as IVD products and satisfy the CE marking criteria for the European Directives:

- IVD Directive
- Low-Voltage Directive
- Electromagnetic Compatibility Directive
- RoHS Directive

in their currently valid versions.

A declaration of conformity can be requested from the manufacturer by providing the serial number.

## 1.4 Technical data

SONOPULS ultrasonic homogenisers are interference-free and marked with CE.

Safety: EN 61010-1;

EMC: EN 61326-1

### 1.4.1 Ultrasonic generator (GM)

Operating voltage	230 V~ ( $\pm 10\%$ ) 50/60 Hz, alternatively 115 V~ ( $\pm 10\%$ ) 50/60 Hz, cable length 2 m
Protection class:	I
Ultrasonic frequency:	20 kHz $\pm$ 500 Hz
Frequency control <sup>1</sup> :	automatic, resonance frequency search
Time settings range:	00:01 – 99:59 [mm:ss] or continuous operation
Ultrasonic operating mode:	Pulsating or continuous
Pulsation time ON ( $t_E$ ):	1 - 60s – (see Chapter 3.2.2)
Pulsation time OFF ( $t_A$ ):	1 - 60s – (see Chapter 3.2.2)
Ultrasonic control:	Amplitude – (see Chapter 3.2.3)
Amplitude settings range:	10 - 100 % in 1 % steps
Amplitude indicator:	Presetting and progress bars
Operating controls:	Rotary knob, membrane keys
Operating data display:	LCD graphic display, illuminated
Remote control (turning on/off):	Button on the ultrasonic transducer, potential-free contact, foot switch TS 8 (optional)
Protection code:	IP 20 pursuant to DIN EN 60529

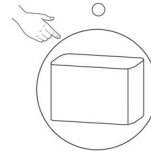

Protected against access by fingers to hazardous parts; protected against solid foreign bodies with a diameter of 12 mm or larger

Not protected against ingress of water

#### Device-specific:

Ultrasonic generator	GM 2070.2	GM 2200.2
Rated ultrasonic output <sup>2</sup> , max.	70 W	200 W
Weight	1.9 kg	2.2 kg
Exterior dimensions (L x W x H)	245 x 215 x 140 mm	

#### 1 Frequency control:

The ultrasonic generator has an automatic search feature for resonance frequency and rate adaptation while in operation. Causes for a change in the resonance frequency are, for example, a warming of the ultrasonic transducer and the probes, a change in the acoustic load due to changes in viscosity, and even the mounting of another probe. A frequency drift during operation is corrected by the automatic frequency control. The optimum working frequency is sought using the resonance frequency search, e.g. after a change in probe.

#### 2 Rated ultrasonic output:

In the case of amplitude control, the ultrasonic power that is needed for the desired probe amplitude is dependent on the viscosity of the medium. In order to prevent damage to the ultrasonic generator and converter, the power is limited to the maximum permitted peak value. In the case of highly-viscous media, this can also result in the desired amplitude not always being reached.



## Ambient conditions pursuant to EN 61 010-1

Overvoltage category:	II
Degree of soiling:	2
Permissible relative humidity up to 31 °C	80 %
Permissible relative humidity up to 40°C:	50 %
Permissible ambient temperature:	5 to 40°C
Temperature in storage:	0 to 50 °C
Altitude:	up to 2000 m

No condensation allowed.  
Only for indoor operation.

## **IVD** Specifications for use as a medical device

Name:	Ultrasonic homogeniser
UMDNS nomenclature (ECRI / DIMDI):	17-125
Purpose:	See Chapter 1.2
Medical device pursuant to Directive 98/79/EC for in-vitro diagnostic medical devices:	other IVD
Type, model, serial number, year of manufacture:	See type plate on the ultrasonic generator for information

The homogeniser has been inspected pursuant to norms currently in effect and must be installed and put into operation pursuant to EMC directions; information in this regard is found in the Appendix.

## Specifications pursuant to the German Medical Devices Operator Ordinance (MPBetreibV):

Start-up on location, functional check and personnel training (section 5):	not required
Technical safety checks, STK (section 6):	no specifications
Technical measurement checks, MTK (section 11):	not applicable

## e-procurement

e-cl@ss:	
HD device classification:	32-08-02-02
HD accessories classification:	32-08-02-05

## 1.4.2 Technical data, ultrasonic transducers

UW 2070 / UW 2200

PZT ultrasonic oscillating system:	✓
Start/Stop key:	✓
Suitable for continuous operation:	✓
Frequency:	20 kHz
Weight:	1.2 kg
Dimensions:	Ø 70 × 120 mm
Protection class:	IP 20

Ambient conditions and explanation of protection class, see Chapter 1.4.

## 1.4.3 Remote operation

Several options are available for remote control and remote operation. Depending on requirements, the most convenient solution may be selected.

	Operating element	Methods	Functions	Connection
1	Button	manual	Ultrasonic operation ON/OFF	Fixed on the ultrasonic transducer
2	Foot switch	foot-operated	Ultrasonic operation ON/OFF	Remote control sleeve
3	External	control signal	<ul style="list-style-type: none"> <li>Ultrasonic operation ON/OFF</li> <li>Status confirmation</li> </ul>	Remote control sleeve

### Remote control connector

Contact assignment and functional description of the remote control connector

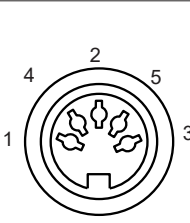
Diagram	Contact	Assignment	Signal	Function	
	1	Input	0V L 5V H	L → Ultrasonic operation ON H → Ultrasonic operation OFF	
	2	not assigned			
	3	Earth			
	4	Output	0V L 5V H	L → Ultrasonic operation OFF H → Ultrasonic operation ON	
	5	Output		As with contact 4, but with signal inverted	



#### Notes:

- The inputs and outputs may not be connected to other circuits, ground planes, or ground terminals.
- The connection of power or voltage sources of any type is not permitted.
- The source resistance for the outputs is of 2.2 k $\Omega$ . The input resistance for subsequent signal inputs, e.g. optocouplers, must be greater than 20 k $\Omega$ .
- The function of the signal input (contact 1) depends on the mode of operation that is set for the pulsation (see Chapter 3.2.2). With the operating mode "by hand key", control is conducted statically, i.e. the ultrasonic operation is always activated under L status, and deactivated under H status. With all other modes of operation, the input works as an edge-controlled changeover switch.
- When connecting a changeover contact (toggle function) to connector 1, the make time must be > 100 ms.



#### Please note:

Proper operation will depend on the length of the connection cable. If an extension is used, a length of 3 m may not be exceeded.

### 1.4.4 Electromagnetic compatibility (EMC)



The device has been checked for electromagnetic compatibility in accordance with DIN EN 61326-1 and meets the requirements for Class B devices in accordance with EN 55011. It is suitable for use in institutions and other areas that are directly connected to a public low-voltage power supply, e.g., medical laboratory facilities.

## 1.5 Warnings and safety precautions

### General information

- Keep the device and accessories out of the reach of children and also of persons who have not been instructed in their operation by reference to these instructions.
- The use of the device or parts thereof on humans or animals is not authorised.
- Keep the ultrasonic generator and operating controls clean and dry.
- Do not expose the device to corrosive materials.
- When working with the device, please observe hygiene instructions pursuant to Chapter 5.2.
- The connection of any type of power or voltage sources to the signal inputs or outputs is forbidden.
- Signal wires for foot switches, temperature sensors, etc., may not exceed a maximum length of 3 m.
- All plug connections (such as for ultrasonic transducers, foot switches) may only be plugged or unplugged while the device is turned off.
- The ultrasonic generator and ultrasonic transducer must be transported separately.
- The homogenisers adhere to prescribed EMC limit values, such that it can be assumed that the electromagnetic radiation emanating from the units is harmless to humans. A binding statement for wearers of implants can only be made at the place of work and together with the implant manufacturer. In case of doubt, information regarding the allowable electromagnetic exposure level should be obtained from the implant manufacturer.

### Operation

- Observe ambient and set-up conditions, see Chapter 1.4.
- Determine the mains voltage before connecting the ultrasonic generator.
- Only connect the ultrasonic generator to an earthed socket.
- The ultrasonic transducer may only be firmly mounted on the black housing using a suitable support, e.g. stainless steel stand.
- Before each startup, check that the probe is firmly positioned on the standard or booster horn; if necessary, tighten the probe (see Chapter 4.3.1).
- Do not touch any oscillating parts (e.g. standard or booster horns, micro tips or tapered tips, titanium plates, ultrasonic transducer) during operation! Damage to health is possible.
- Do not touch the sonication vessels with the oscillating probe – probes and vessels could be damaged.
-  The sonication of liquids generates noise. Suitable accessories, such as a sound proof box, will minimise such noise considerably. If operating without a sound proof box, wear hearing protection.
-  Warning, risk of splashing!  
This is especially the case with small sample quantities and when immersing oscillating probes.
- Do not use combustible solvents in open reaction vessels since the operating safety of the homogeniser could be compromised. Safe extraction of combustible vapours must be guaranteed. When using a sound proof box, the vapours cannot escape.
- Before any mounting or dismounting (Chapter 4.4) of probes or standard/booster horns as well as accessories, turn off the device and disconnect the ultrasonic transducer from the ultrasonic generator.

- Only use the prescribed tool for mounting and dismounting (see Appendix A).
- Do not use any bent probes (⇒ unstable operation, loss of power).
- Liquids must not penetrate the inside of the ultrasonic transducer.
- Never twist the ultrasonic transducer's black housing toward the aluminium cylinder (ultrasonic oscillating system). The ultrasonic oscillating system and its electrical connections would be destroyed as a result.
- Do not operate the device without supervision.



#### **IVD** Advice for the medical and laboratory field

- The homogeniser is exclusively intended for use by skilled medical personnel.
- It may generate radio interferences or disrupt the operation of devices nearby. It may be necessary to take remedial measures such as realigning the device or reconfiguring the homogeniser or the shield.
- During operation, portable or mobile HF communication systems in the vicinity of the homogeniser should be turned off – operation may be disrupted.

#### **Damage**

- If damage to the homogeniser is detected, do not connect the homogeniser to the mains.
- In the event of defects, disconnect the mains plug immediately.
- Repairs are only to be conducted by authorised skilled personnel or by the manufacturer.
- Defective parts must only be replaced with original parts or parts of the same quality!

## 2 Preparation

Carefully unpack the ultrasonic generator, ultrasonic transducer and accessories, and inspect them for completeness or possible transportation damage. If damage or a defect is found, communicate this to the responsible forwarding agent and supplier immediately in writing.

### 2.1 Scope of delivery

The scope of delivery will depend on the size of the order. However, it will generally include the following parts:

- 1 Ultrasonic generator (GM) ... – see delivery note, with mains cable NL 5 xx
- 1 Ultrasonic transducer UW ...
- 1 Standard horn or booster horn SH ... (already firmly screwed-in)
- 1 Probe
- 1 Tool set WZ 2
- 1 Manual

Additional accessories according to order – see delivery note

### 2.2 Set-up / assembly

- Place the ultrasonic generator atop a firm, level and dry surface. In doing so,
  - do not group it or stack it over other electric or non-electric devices.
  - do not cover the ventilation holes on the ultrasonic transducer's housing,
  - guard against moisture and wet – risk of electric shock.
- During delivery, the standard or booster horn is already firmly screwed to the corresponding ultrasonic transducer.  
Other standard or booster horns are mountable. To do so, see instructions in Chapter 4.4.
- Screw together the supplied probe with the standard or booster horn, see Chapter 4.3.1.
- Position the ultrasonic transducer safely and correctly inside the holder.  
To do so, affix the ultrasonic transducer onto the sound proof box's supporting ring or firmly mount the ultrasonic transducer on the black housing alone, using a suitable support, e.g. a stainless steel stand.
- Connect the ultrasonic transducer to the ultrasonic generator.  
To do so, insert the plug from the ultrasonic transducer into the ultrasonic connector located on the rear side of the generator, and tighten using the threaded ring. If necessary, see Chapter 1.
- Verify that the power switch is in the "0" position.
- Before the mains connection, identify the pertinent mains voltage, compare it with the type plate on the generator bottom, and only connect a suitable type to an earthed socket.



#### Please note:

- Avoid any contact between the contact pins on the ultrasonic transducer's plug, since the piezo elements could generate electric loads through temperature fluctuations ⇒ with a possibility of slight electric shocks.

## 2.3 Start-up

- Check the positioning of the ultrasonic transducer in the holder.
- Check the firm positioning of the probe and, if needed, clean thoroughly before first use.
- Connect the ultrasonic generator to the mains (earthed socket) and switch on.
- Set the probe type (see Chapter 3.1.1)
- Conduct function test as described in Chapter 6.2.1.

## 3 Operation

### 3.1 Operating controls

Operation is conducted from the operating and display panel on the front side of the ultrasonic generator:

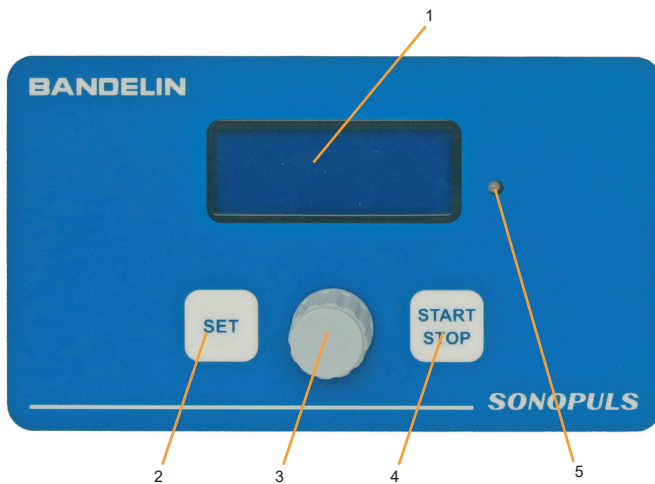

1	LCD Display	Display of the operating parameters and status information
2	"SET" key	Calling up the list of editable operating parameters, moving within the menu (forward)
3	Rotary knob	Setting the operating parameters (right/left, without dead stop)
4	"START/STOP" key	Starting or stopping the ultrasonic output, ending functions, exiting the menu
5	Control LED	green light: Ultrasonic output red light: Error messages flashing red: Warning messages Off: Standby mode (PAUSE)

### 3.1.1 Turning the homogeniser on/off

The homogeniser is turned on using the power switch on the rear side of the ultrasonic generator. After turning on, the LCD display must light up. Initialisation occurs automatically. The ultrasonic homogeniser will display the manufacturer's name, type designation, and the last-connected sonotrode [probe].

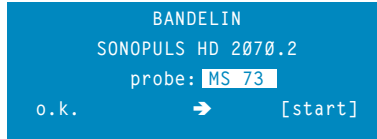

If the probe type displayed does not conform with the probe that is mounted, the correct probe type will have to be set before the next step using the rotary knob. By pressing the "START/STOP" key, the menu switches into stand-by mode (PAUSE) and the ultrasonic homogeniser is ready for operation. The parameters used during the last operation will be set again and displayed.

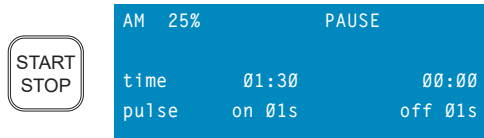

The mains switch can also be used for powering off. When the ultrasonic generator is powered off, the memory contents are saved and become available again when the generator is powered on.

### 3.1.2 Explanation of the display fields

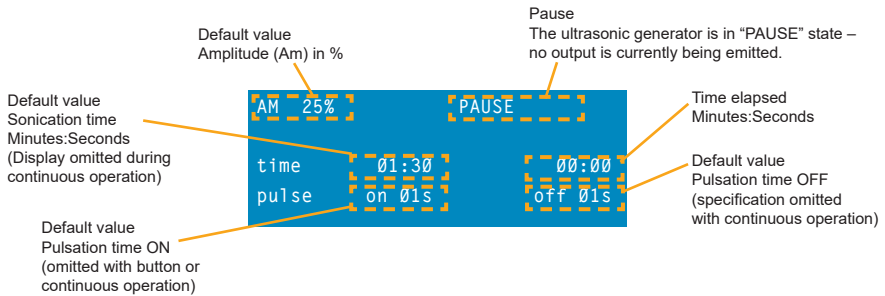

## 3.2 Setting the operating parameters

With the exception of the amplitude, the operating parameters can only be set while in stand-by mode (PAUSE). The editing mode is activated by pressing the "SET" button. It is possible to switch between the individual parameters by repeatedly pressing the "SET" button. In the marked area (inverse view) of the selected parameter, the desired value is set by turning the rotary knob. By pressing the "START/STOP" button, the editing mode is exited.



The following operating parameters can be set:

- Default values for the amplitude [AM]
- Default values for the sonication time [time]
- Default values for the pulsation of the ultrasound (turn-on and turn-off time) [pulse]

### 3.2.1 Sonication time [time]

A default value of 99 minutes and 59 seconds (99:59) is the maximum sonication time that can be set. If the default value is exceeded during ultrasonic operation, the sonication will stop. The parameter “non-stop” is equivalent to unlimited continuous operation until ultrasonic operation is ended by pressing the “START/STOP” key.

#### a) Set continuous operation [non-stop]

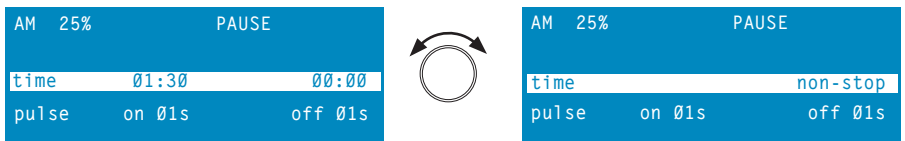

#### b) Setting the sonication time

If a value of 59 seconds is exceeded when setting the time, or if a shortfall occurs when setting back the time, the values for the set minutes will change accordingly.

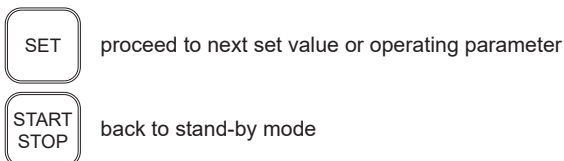
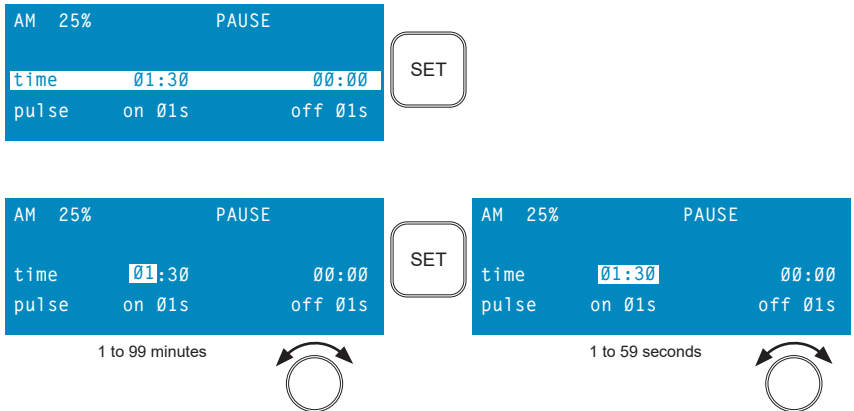

### 3.2.2 Pulsation [pulse]<sup>3</sup>

In addition to setting the pulse turn-on time  $t_E$  and the pulse turn-off time  $t_A$ , two additional operating modes can also be set:

off No pulsation or continuous sound  
 by hand key It is possible to pulse manually with the key on the ultrasonic transducer. Ultrasonic operation will be active as long as the key on the ultrasonic transducer is pressed.

#### a) Setting the operating modes

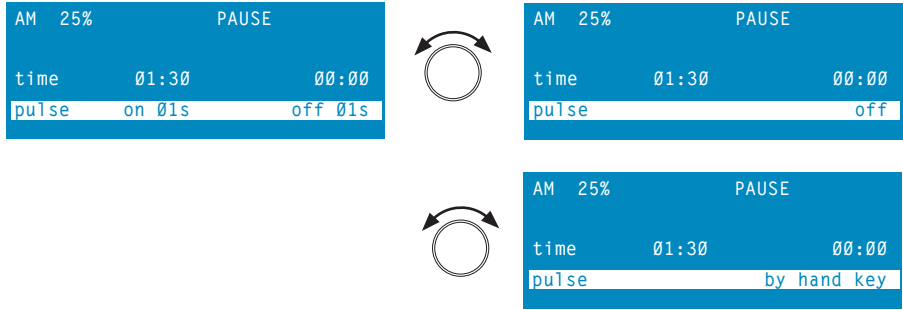

#### b) Setting the time intervals

The maximum setting value is 60.0 s. The minimum setting value at 1 s.

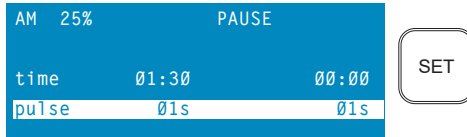

Turning-on time  $t_E$

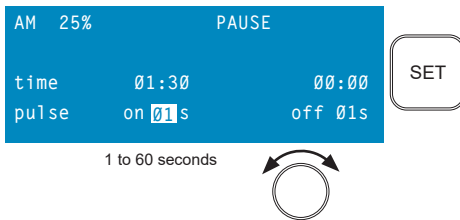

Turning-off time  $t_A$

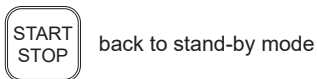
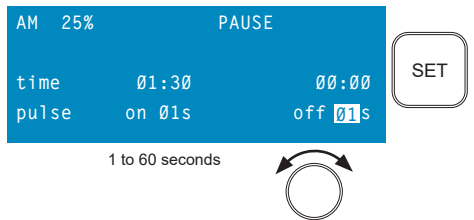

<sup>3</sup> The pulse period duration is the sum of the turn-on and turn-off time  $t = t_E + t_A$

### 3.2.3 Special functions

Additional functions are available within a second menu level. These can be accessed by pressing and holding the “SET” button for approximately 2 seconds. Switching between these functions is accomplished in the manner already described. The menu level can only be exited by pressing the “START/STOP” key. In doing so, settings and function statuses are carried over and executed.

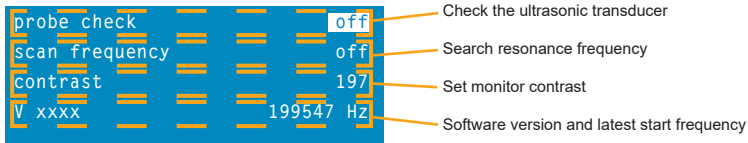

#### Check the ultrasonic transducer [probe check]

This function is used for quick verification of whether the ultrasonic transducer is recognised by and can be correctly activated by the ultrasonic generator. After a change in probe or in operating conditions it is possible, for example, that the ultrasonic generator cannot synchronise with the ultrasonic transducer and issues an error message, e.g. Error 011. The ultrasonic frequency is reset to the base value and the function is restored if no device fault or other cause is present.

The default value is “off”. In order to activate the function, set the parameter to “start” using the rotary knob, and then press the “START/STOP” button. See Chapter 6.2.1 for additional information.

#### Search for resonance frequency [scan frequency]

This function is an expansion of the above-mentioned “probe check” function. In addition, a frequency scan is conducted in order to determine the correct HF or ultrasonic frequency for the ultrasonic transducer. Depending upon the probe used and the operating conditions, the frequency can fluctuate significantly, to some extent. When switched off, the ultrasonic generator saves the current frequency value and uses it as the start value when switched on again. If there are significant deviations in the current ultrasonic frequency, this can lead to malfunctions.



#### Please note:

After a successful scan while in continuous operation (pulsation = off, time > 30 s), start with an amplitude setting of 50 % and check the operation. Next, set the desired default value.

#### Setting the monitor contrast [contrast]

With this function, the monitor contrast can be adapted to the local light conditions. The contrast values range between 1 and 255, and can be set by turning the rotary knob. Smaller values result in a darker image and larger values result in a lighter image. The default value is 240.

### 3.3 Activating / deactivating the ultrasound

Ultrasonic operation can be started and stopped by pressing the “START/STOP” key or the key on the ultrasonic transducer. Ultrasonic operation ends once the target time has elapsed (if a time has been set), and a signal tone (long + short) is emitted. When the device is restarted, the displays for the elapsed sonication time and for the energy are set to zero.

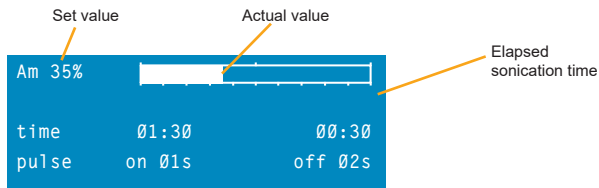

In contrast to stand-by mode, ultrasonic operation displays the actually achieved value in bar graph form, in addition to the pre-set amplitude.



#### Please note:

Depending upon the physical conditions, i.e. the viscosity of the sonicated medium and the thus-resulting control processes, a difference between the target and the actual value, as well as a fluctuating display, may occur.

The amplitude can be changed at any time during ultrasonic operation, using the rotary knob. All other operating parameters can only be edited while in stand-by mode (see Chapter 3.2).



#### Notes:

- If the ultrasonic operation is manually interrupted before it reaches the activated target time, the display values for the elapsed sonication time and for the energy will be saved and will continue running upon restart. The display values can be reset to zero by pressing the “SET” key and then pressing the “START/STOP” key.
- With the “non-stop” setting, the elapsed sonication time and energy must also be manually reset, if needed. Once the maximum displayable time has been reached and exceeded, the time display will start again at 00:00.

## 4 Usage

### 4.1 Instructions for use



- Do not touch the sonication vessels with the oscillating probe – probes and vessels could be damaged.
- The recommended immersion depth for probes is of 10 - 20 mm, to prevent the aspiration and mixing-in of air. If mixed-in air is desired, the probe may be immersed just a few millimetres. In the case of greater immersion depths and/or the sonication of liquids with high viscosities, the probe is more heavily damped. As a result, it is possible that the pre-set amplitude may not be reached, especially with higher default settings (>50 %). The reason is that the ultrasonic generator can no longer provide the required power, or the power limit value has been reached (protective function).
- The immersion depth may not exceed 20 mm in the case of micro and tapered tips.
- When producing emulsions, the probe should be immersed to the level of the interface between the liquids to be mixed.
- Do not use combustible solvents in open reaction vessels since the operating safety of the homogeniser could be compromised.



- In order to shut down the device, disconnect it from the mains (pull the plug).

### 4.2 General use

Before starting use, the important instructions under Chapter 4.1 should be heeded!

#### **Step 1: Check the ultrasonic transducer**

- Verify that all connecting cables and couplings are correctly connected.
- The probe type must conform to the sonication volume, see table in Chapter 4.3.
- The probe must be clean, faultless, and firmly mounted.
- The ultrasonic transducer must be securely affixed.

#### **Step 2: Prepare the sonication**

- Prepare the sonication medium.
- Position the sonication vessel below the ultrasonic transducer in such a manner that the probe
- Set the immersion depth for the probe (approx. 1 - 2 cm).

### **Step 3: Turn on the homogeniser**

- Turn on the homogeniser with the power switch.
- All saved data and settings will be loaded. Check the settings and change them if necessary, see Chapter 3.2.

### **Step 4: Activate the ultrasound**

- Select a small amplitude at the start to prevent any splashing onto the ultrasonic transducer. Observe the maximum allowed amplitude, see Chapter 4.3.
- Activate the ultrasound



Warning: risk of splashing!

This is especially the case with small sample quantities and when immersing oscillating probes.

### **Step 5: Remove the sample**

After sonication, the probes must be removed from the medium. Leaving them in the sonicating medium for a longer time can cause damage to the probe.

- Once the programme or time setting has elapsed, the delivery of ultrasound ends automatically.
- If continuous sonication has been set, the ultrasonic output must be stopped manually.
- Remove the probe and the temperature sensor, if applicable, from the sonicating medium.

### **Step 6: Clean the probe**

In order to prevent contamination with other sonicating media, probes are to be thoroughly cleaned after every sonication, see Chapter 5.2.

- Turn off the homogeniser with the power switch.
- Clean the probe and check the wear on the sound emitting surface at regular intervals, see Chapter 5.1.

## 4.3 Selecting a suitable probe

Detailed information on the individual probes can be found in the separate product information.

HD 2070.2							
Probe Ø	MS 72 2 mm	MS 73 3 mm	KE 76 6 mm	TT 13 13 mm	VS 70 T 13 mm	TT 13 FZ 13 mm	BR 30
Connection to standard horn	SH 70 G, (FZ 5 G)					FZ 5 G	-
Sonicating vol.	1 ml - 25 ml	2 ml - 50 ml	5 ml - 100 ml	10 ml - 200 ml	10 ml - 200 ml	-	-
Amplitude*	285 µm <sub>ss</sub>	245 µm <sub>ss</sub>	191 µm <sub>ss</sub>	93 µm <sub>ss</sub>	97 µm <sub>ss</sub>	93 µm <sub>ss</sub>	10 µm <sub>ss</sub>
<b>Maximum permitted amplitude setting</b>	<b><u>95 %</u></b>	<b>100 %</b>	<b>100 %</b>	<b>100 %</b>	<b>100 %</b>	<b>100 %</b>	<b>100 %</b>

HD 2200.2									
Probe Ø	MS 72 2 mm	MS 73 3 mm	KE 76 6 mm	TT 13 13 mm	VS 70 T 13 mm	TT 13 FZ 13 mm	VS 190 T 19 mm	TT 25 25 mm	VS 200 T 25 mm
Connection to standard horn	SH 213, SH 213 G, (FZ 7 G)					FZ 7 G	SH 219 G	SH 225 G	
Sonicating vol.	2 ml - 30 ml	5 ml - 90 ml	10 ml - 350 ml	20 ml - 900 ml	20 ml - 900 ml	-	25 ml - 900 ml	30 ml - 1000 ml	30 ml - 1000 ml
Amplitude*	286 µm <sub>ss</sub>	308 µm <sub>ss</sub>	255 µm <sub>ss</sub>	165 µm <sub>ss</sub>	170 µm <sub>ss</sub>	165 µm <sub>ss</sub>	81 µm <sub>ss</sub>	53 µm <sub>ss</sub>	51 µm <sub>ss</sub>
<b>Maximum permitted amplitude setting</b>	<b><u>50 %</u></b>	<b><u>65 %</u></b>	<b><u>75 %</u></b>	<b>100 %</b>	<b>100 %</b>	<b>100 %</b>	<b>100 %</b>	<b>100 %</b>	<b>100 %</b>

HD 2200.2	
Probe Ø	BR 30      BB 6
Connection to standard horn	-              -
Sonicating vol.	-              -
Amplitude*	10 µm <sub>ss</sub> 7 µm <sub>ss</sub>
<b>Maximum permitted amplitude setting</b>	<b>100 %</b> <b>100 %</b>

\* Amplitude values may differ slightly from the indicated value due to material and manufacturing tolerances.

### 4.3.1 Mounting and dismounting of the probes

Probes

- are screwed onto the standard or booster horns,
- transmit ultrasonic power into the medium to be sonicated,
- are made of high-strength titanium alloy.



Caution! Probes are sensitive to shock.

Before mounting or dismounting the probes, the ultrasonic generator must be turned off and the ultrasonic transducer must be disconnected from the ultrasonic generator.

The mounting surfaces<sup>4</sup> must be thoroughly cleaned so that the amplitude and/or power can be transmitted to the medium.

If the mounting surfaces are not cleaned, the probe, standard horn or booster horn could be destroyed as a result.

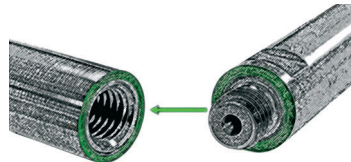

The tool required for mounting/dismounting is included in the scope of supply.

<sup>4</sup> The mounting surfaces are the contact surfaces between the individual accessory parts, e.g. between the standard or booster horn and the probe.



### 4.3.1.1 Mounting and dismantling the titanium plates

- Titanium plate TT 13 /FZ, TT 19, TT 25
  - In standard horn SH 70 G, the TT 13 is mounted onto HD 2070.2, and in booster horn SH 213 G, it is mounted onto HD 2200.2.
  - In flow-through standard horn FZ 5 G, the TT 13 FZ is mounted onto HD 2070.2, and in flow-through booster horn FZ 7 G, it is mounted onto HD 2200.2.
  - In booster horn SH 225 G, the TT 25 is mounted onto HD 2200.2.
- Next, carefully wipe the mounting surfaces of the standard and/or booster horns and of the respective titanium plate ⇒ to ensure clean mounting surfaces.
- Screw on the titanium plate by hand.
- Spanners – SW 10 for TT 13 and TT 13 FZ, SW 22 for TT 25 – apply to the steel fitting of the titanium plate.
- Firmly hold the standard or booster horn using sickle spanner HS 40/42, and firmly mount the titanium plate to the standard or booster horn.
- Dismount in the reverse direction.

Video available under:

[https://www.youtube.com/watch?v=hjTC\\_cvO4kQ](https://www.youtube.com/watch?v=hjTC_cvO4kQ)

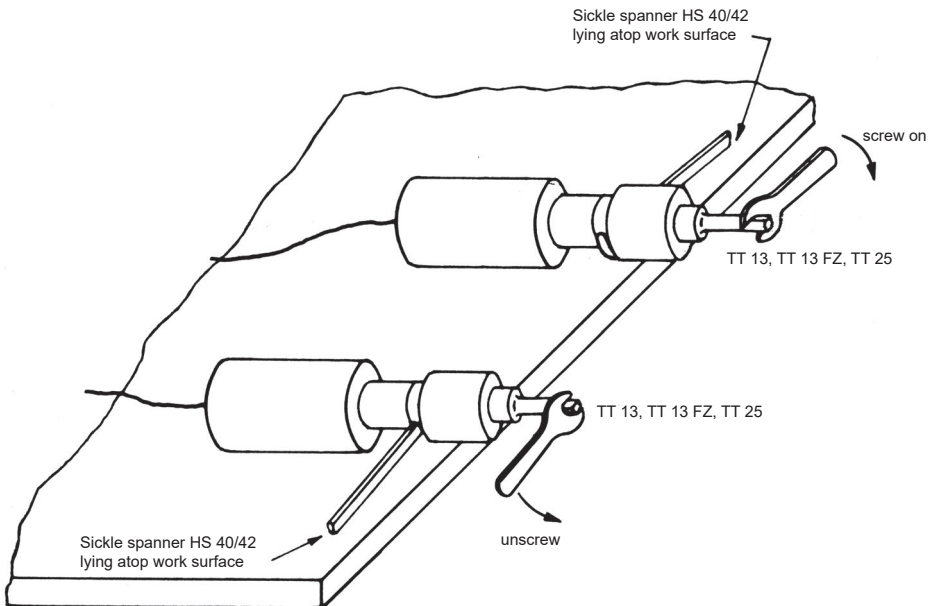

### 4.3.1.2 Mounting and dismounting of micro and tapered tips and long probes

- Micro- and tapered tips (MS 72, MS 73, KE 76), long probes (VS 70 /T, VS 200 /T)
  - MS 72, MS 73 and KE 76 are mounted on HD 2070.2 onto standard horn SH 70 G.
  - MS 72, MS 73, KE 76, VS 70 /T are mounted on HD 2200.2 onto booster horn SH 213 G.
  - VS 190 T is mounted on HD 2200.2 onto booster horn SH 219 G.
  - VS 200 /T are mounted on HD 2200.2 onto booster horn SH 225 G.
- Next, carefully wipe the mounting surfaces of the standard and/or booster horns and of the probe ⇒ ensure clean mounting surfaces.
- Screw on the probe by hand.
- Lay the probe on an approx. 20 mm thick base so that it does not bend.
- Firmly hold the standard or booster horn in place using sickle spanner HS 40/42, and tighten the probe using the appropriate spanner, see illustration.
- Dismount is conducted in the reverse direction.

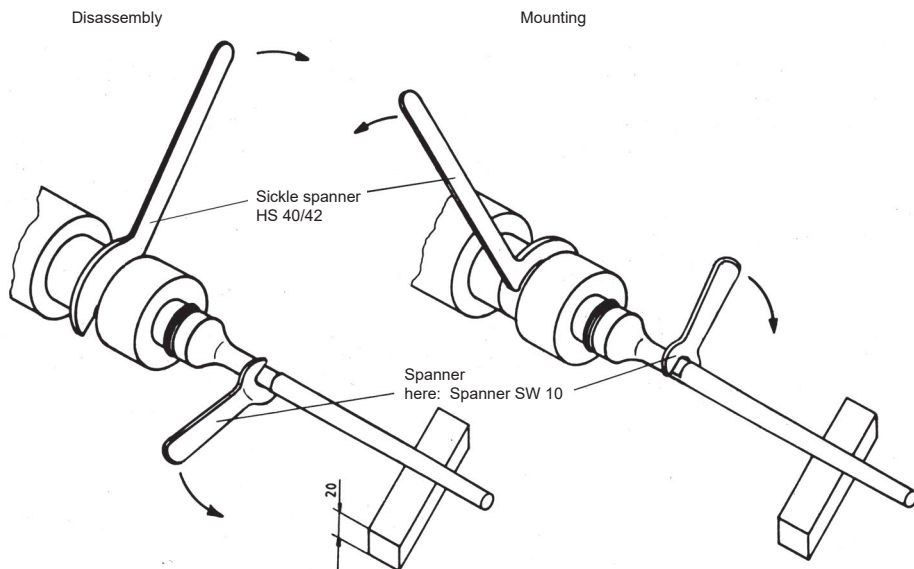

## 4.4 Dismounting and mounting of the standard and booster horns

Standard and/or booster horns

- are screwed onto the respective ultrasonic transducer,
- are made of high-strength titanium alloy.
- transmit the oscillations to the probe,
- enhance the amplitude thanks to their geometry.

At the time of delivery, standard horn SH 70 G and booster horn SH 213 G, are firmly mounted onto the HD 2070.2 and HD 2200.2 respectively, on the ultrasonic transducer.

Before mounting the standard or booster horn, the ultrasonic generator must be turned off and the ultrasonic transducer must be disconnected from the ultrasonic generator.

- Release the firmly-mounted standard and/or booster horn SH 70 G, SH 213 G or SH 3425 from the ultrasonic transducer UW 3100, UW 2070 or UW 2200, respectively. To do so, lay the ultrasonic transducer on a firm base (non-slip, if possible).

Video available under:

<https://www.youtube.com/watch?v=NXbGc6nAb5c>



### Disassembly

- Place one sickle spanner on the ultrasonic transducer and the other sickle spanner on the standard or booster horn. To dismount, press the first sickle spanner against the firm base, press the other sickle spanner firmly in the opposite direction.

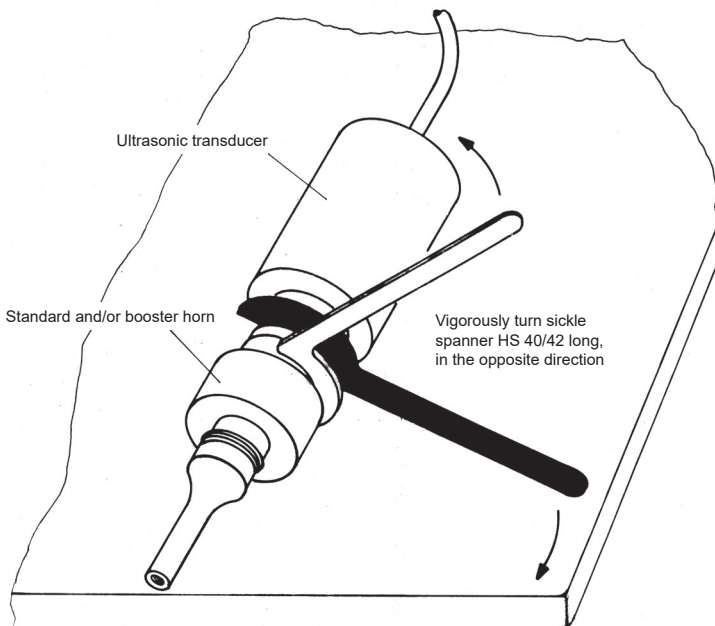

## Assembly

- Keep the surfaces/threads to be screwed clean; clean them with alcohol and a lint-free cloth, if needed.
- Screw approx. 2/3 of the length of the threaded bolts of the new standard or booster horn to be mounted, into the mounting surface of the ultrasonic transducer.
- Place a plastic ruler or similar on the threaded portion of the bolt and press lightly in the direction of the arrow ⇒ This will prevent the bolt from turning any further when the standard or booster horn is screwed on.

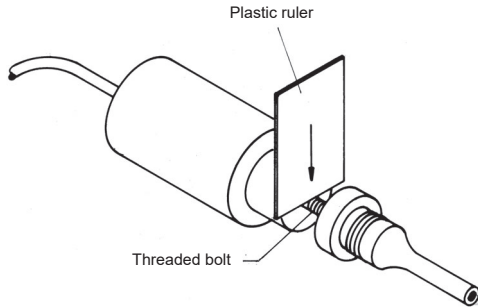

Screw the standard or booster horn onto the threaded bolt and first tighten by hand after removing the ruler.

- Then, mount the standard or booster horn firmly onto the ultrasonic transducer using both sickle spanners.

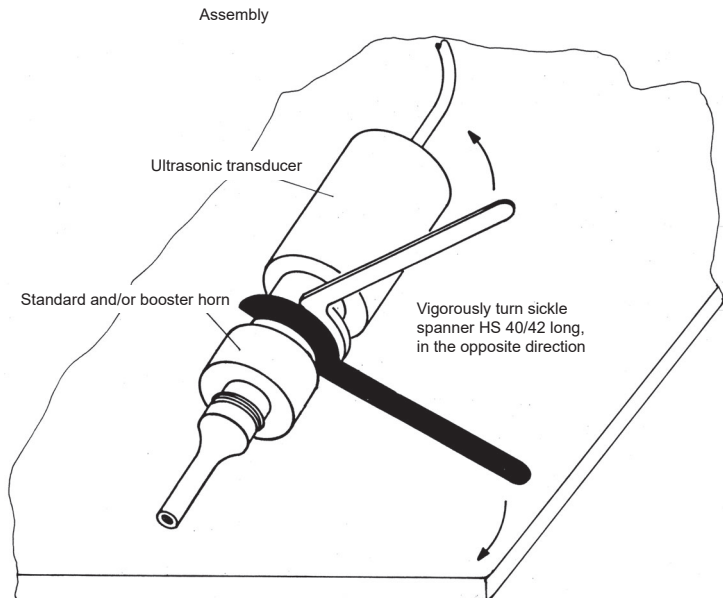

Detailed information on the individual standard and/or booster horns can be found in the separate product information.

- ⚠ The black housing of the ultrasonic transducer and the aluminium cylinder (ultrasonic oscillating system) must not be twisted toward each other. The ultrasonic oscillating system and its electrical connections would be damaged as a result.

## 5 Cleaning and maintenance of the homogeniser

To achieve an optimum lifespan for the homogeniser, cleaning and maintenance are to be conducted regularly.

### CAUTION:



Always disconnect the homogeniser from the mains before performing cleaning/maintenance.



Do not rinse or immerse the homogeniser in water and do not expose it to splash water.

**A warranty will not apply to damage caused by the use of unsuitable disinfection agents or detergents.**

### 5.1 Cleaning and care

#### Probes

All probes are subject to process-related wear, which leads to erosion on the sound-emitting surface and thus to a reduction in power.

In the case of frequent use, it is recommended that an inventory supply of probes be kept.

Examples of wear, e.g. on titanium plate TT 13:

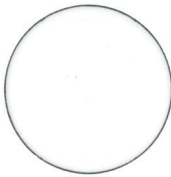

New titanium plate



Erosion still permissible, plate can be polished

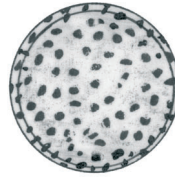

Start of pitting, milling or grinding necessary

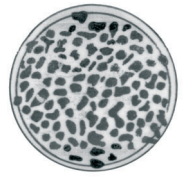

Limit value for erosion exceeded, replacement necessary

The sound-emitting surfaces can be carefully polished or milled a few times. If material residue due to erosion or post-processing exceeds a value of approx. 1 mm, or if there is no power display on the generator, the probe is non-resonant and can no longer be used.

Reconditioning of the sound-emitting surface:

Reconditioning can be performed using a grinding machine with a fine grinding wheel of suitable grain size, or by hand using a diamond file. Suitable grinding materials are, for example:

- Fine abrasive wheel, polyurethane-bound – grain size 150
- Fine abrasive wheel, rubber-bound – grain size 120
- Grinding wheel PNK, corundum – grain size 180 ... 280
- Diamond file, D 181 or D 251

#### Ultrasonic transducer/ultrasonic generator

- Do not use any abrasive cleaners, only commercial care products without abrasive additives.
- Housing is to be wiped off only from the outside, use a suitable surface disinfectant if needed. Afterwards, allow to dry off or wipe dry.

## 5.2 Treatment of contaminated parts in the ultrasonic transducer, vessels and accessories pertaining to the medical field



When working with ultrasonic homogenisers, the sonicating parts, vessels and other accessories (e.g. stands, mounting tools) could become contaminated with micro-organisms or toxicological agents and lead e.g. to cross-infections. Disinfection and/or cleaning is required.

In the event of incorrect or irregular disinfection and cleaning, contamination is possible, especially at the connecting points (e.g. between titanium plate and standard horn) and at the sound-emitting surfaces (see Chapter 5.1, Wear).

Therefore, the sonicating parts (such as the standard or booster horn, micro tips or tapered tips, and titanium plates), vessels and accessories should be disinfected and cleaned after every use, and dismantled for this purpose if necessary.

In the event of toxic contamination, the applicable regulations and provisions of BGR 250/TRBA 250 are especially to be observed.

The disinfection and cleaning should be performed regularly by the operator, if applicable in accordance with the hygiene plan and using a VAH-certified or other effective surface disinfectant.



### **Please note:**

Additional information and provisions locally applicable at the user's/operator's site must be observed.

## 5.3 Positioning / storage

During extended periods without use, the homogeniser should be stored in a cool, dry place. The ultrasonic transducer should be covered in order to protect the electronics from outside contamination.

# 6 Maintenance and repair

## 6.1 Maintenance

SONOPULS homogenisers are maintenance-free.

Aside from the process-dependent cavitation erosion on the sound-emitting surface of the probes, no other homogeniser parts are subject to wear. Worn out or faulty probes can be replaced following the instructions in Chapters 4.3.1 to 4.4.

The devices are calibrated at the time of delivery. A control of the calibration is only required after repairs, and will only be conducted by the manufacturer.

## 6.2 Functional checks

See also Chapter 3.2.3 for description and operation.

### 6.2.1 Testing the ultrasonic transducer (probe check) – Error 011

The test is preferably conducted while the probe is acoustically uncoupled, i.e. the probe should not be immersed in the sonicating medium.

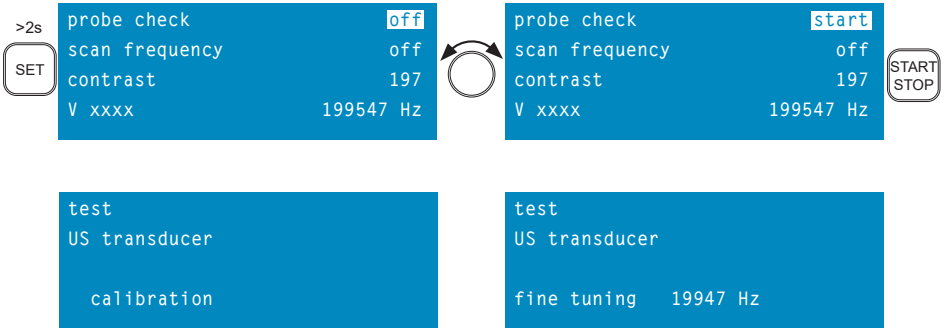

The ultrasonic frequency depends on the probe, and the actual value may vary from the example presented here. After successful completion, the monitor display switches back to stand-by mode. Otherwise, an error message appears again.

### 6.2.2 Conducting a frequency scan (scan frequency) – Error 002/011/012

The conditions for execution are similar to those for conducting checks with the “probe check” function, see Chapter 3.2.3.

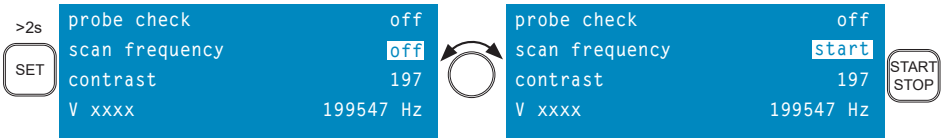

searching  
resonance frequency

calibration

searching  
resonance frequency

scanning 20496 Hz

searching  
resonance frequency

fine tuning 19945 Hz

The frequency scan is completed once fine-tuning has been successful, and the display switches back to stand-by mode.

Otherwise, an error message such as Error 012 appears again.



#### **IMPORTANT:**

Only allow repairs to be conducted by authorised skilled personnel!

Kindly inform us in writing of any malfunctions – use the enclosed questionnaire.



#### **Important information**

- Before each repair, turn off the device and disconnect the plug from the mains!
- Defective parts may only be replaced with original parts.

The black housing of the ultrasonic transducer and the aluminium cylinder (ultrasonic oscillating system) must not be twisted toward each other. The ultrasonic oscillating system and its electrical connections would be damaged as a result.



## 6.3 Troubleshooting

Errors may arise

- on the plug connections
- on the ultrasonic transducer
- on the probes
- on the Ultrasonic generator:

The device is robustly constructed and designed for a high level of reliability. Nevertheless, the possibility of a malfunction due to a defective component can never be fully discounted. Mechanical defects of the HF connector sockets, the plug connectors, the ultrasonic transducer, etc., are possible as a result of frequent use or even incorrect handling, e.g. by dropping them.

Critical faults are recognised by the device and signalled by a red LED and an intermittent signal tone (3 times), and displayed with an error number, see next page.

Error no.	Possible cause	Remedial action
002	Frequency setting not possible	Perform frequency scan. If the error occurs again, contact BANDELIN.
003	No power output, amplitude setting not possible	Error correction should only be carried out by BANDELIN. Send in the complete ultrasonic homogeniser.
004	Mains voltage fallen short of	Check mains connection, check fuse
011	No return signal from USC, USC or probe defective	<ul style="list-style-type: none"><li>- Check whether the probe has been mounted correctly = sufficiently tight</li><li>- Check for damage:<ul style="list-style-type: none"><li>• Horn/probe contact surfaces</li><li>• Horn/probe threads</li><li>• Probe radiation surface</li></ul></li></ul> If needed, replace the USC/probe and then check its function. Use the "probe check" or "scan frequency" functions for this purpose. After successfully completing the frequency scan, do not restart operation until initialization is complete. In the event of failure, contact BANDELIN.
012	Error in frequency scan, no resonance frequency found, probe defective	
014	Permissible internal operating temperature exceeded, ultrasonic homogenizer switches off	Allow the ultrasonic homogeniser to cool down for at least 10 minutes, if necessary use a temperature sensor to check that the operating temperature of the GM has dropped to < 50 °C.

### Note

- If it was possible to remedy the error, the display indicator should be deleted by turning off and on again.

## General device errors

Problem	Possible cause	Remedy
Device cannot be switched on? (display without function)	No mains power Mains cable loose or faulty?  Device fuse tripped?  Main fuse faulty?	<ul style="list-style-type: none"> <li>- Check that plug connection is firmly in place.</li> <li>- Check the cable for continuity or, if needed, exchange the mains connector.</li> <li>- Replace fuses. The fuses are located in the mains socket on the rear side of the ultrasonic generator, see Chapter 1. (2 fuses: F2A)</li> <li>- Replace main fuse.</li> </ul>
Little or no ultrasonic power?	<p>Is the connection from the ultrasonic transducer to the standard or booster horn, or from the horn to the probe not secure? Standard horn, booster horn, or probe faulty?</p> <p>Check for erosion on the titanium plate / probe – see Chapter 5.1. slight?  slight pitting?  heavy pitting?</p> <p>Has liquid seeped in between the standard or booster horn and the probe?</p> <p>Is the threaded pin attachment on the titanium plate defective?</p> <p>Are the threaded bolts on the standard and/or booster horns cracked?</p> <p>Wrong resonance frequency?</p>	<ul style="list-style-type: none"> <li>- Using the tool supplied, separate parts from one another, clean the surfaces, and firmly screw together once again, see Chapters 4.3.1... 4.4.</li> <li>- Check the horn, probe and threaded pins for cracks, if necessary remove and replace. ⇒ Ensure that the surfaces are clean and smooth, see Chapter 4.3.1.</li> <li>- Polish the titanium plate and/or probe.</li> <li>- Grind or mill the titanium plate and/or probe until flat (max. 1 mm).</li> <li>- Replace the titanium plate and/or probe with new ones.</li> <li>- Dismount the probe, clean the mounting surfaces and threads, dry and check for evenness, remount the probe and tighten, see Chapter 4.3.1.</li> <li>- Replace the titanium plate, see Chapter 4.3.1.</li> <li>- Disassemble the parts, check the threaded bolt, replace if necessary, reassemble the parts, see Chapter 4.3.1.</li> <li>- Conduct frequency scan, see Chapter 6.2 (search frequency).</li> </ul>
Significant heating in the vicinity of the mounting surfaces between the ultrasonic transducer and standard horn and/or booster horn or standard and/or booster horn – probe?	<p>Sonicating parts (standard and/or booster horn and probe) not mounted firmly enough?</p> <p>Are mounting surfaces of the sonicating parts soiled?</p>	<ul style="list-style-type: none"> <li>- Dismount the respective parts, clean the surfaces and firmly retighten, see Chapter 4.4.</li> </ul>

If it is not possible to rectify the error using these short instructions, please contact your local specialist dealer or write us to the address below.

## 6.4 Repairs and service

If you identify errors or defects that cannot be rectified, the homogeniser may not be used. In such a case, please contact the supplier or the manufacturer:

BANDELIN electronic GmbH & Co. KG  
Heinrichstraße 3-4  
12207 Berlin, Germany

Repairs/Maintenance Department:  
Phone: +49-(0)-30 – 768 80 – 13  
Fax: +49-(0)-30 – 76 88 02 00 13

E-mail:  
[info@bandelin.com](mailto:info@bandelin.com)

Returns are subject to the General Conditions of Delivery and Payment of BANDELIN electronic GmbH & Co. KG. In addition, the homogeniser must be cleaned and decontaminated (if necessary), see the following Chapter.

### 6.4.1 Decontamination certificate

If the homogeniser (with accessories, if applicable) is sent back to the manufacturer for repairs, the form "Certificate of Decontamination" must be filled out and affixed to the packaging on the outside, in a visible spot.

If this form has not been filled out, we reserve the right to refuse receipt of the package in order to protect our employees.

The form can be downloaded from our website as a PDF file:  
[www.bandelin.com](http://www.bandelin.com) – Download ...

## 7 Accessories

The proper accessories facilitate use of the ultrasound and also protect the device and materials used at the same time.

BANDELIN offers a broad range of accessories, see Appendix.

Additional information may be obtained from our supplier, our sales representatives or from our website.

No-obligation telephone consultation:  
+49-(0)-30 – 768 80 – 0

Website:  
[www.bandelin.com](http://www.bandelin.com)

### 7.1 Required accessories

In order to mount / dismount standard/booster horns or probes, only use the tools specified in appendix A.

### 7.2 Optional accessories

#### Stand

Stands are used for correct, variable positioning of the ultrasonic converter.

Only ultrasonic converters, and not oscillating elements such as standard/booster horns with probes, may be affixed to the special holder.

An adapter ring AH 50 is required for the UW 50 (supplied in delivery).



#### Sound proof box

The sonication of liquids generates noise. The sound proof box mutes the sound emission up to approximately 30 dB(AU)



The following standard or booster horns can be connected to the ultrasonic transducer:

Homogeniser	HD 2070.2	HD 2200.2
Ultrasonic transducer	UW 2070	UW 2200
Scope of delivery, standard and/or booster horn	Standard horn SH 70 G	Booster horn SH 213 G
Special accessories (must be ordered separately)	Flow-through standard horn FZ 5 G	Booster horns SH 219 G SH 225 G Flow-through booster horn FZ 7 G

## 8 Consumable materials

No consumable materials are available for this ultrasound application.

## 9 Decommissioning

The device must be disposed of appropriately, not with household waste.

Disposal must be conducted in accordance with the Waste, Electrical and Electronic Equipment Directive 2012/19/EU.

Any supplementary/deviating regulations must be observed.



- The device must be decontaminated before disposal. It can then be disposed of as electronic waste. If decontamination is incomplete / cannot be correctly performed, a material safety data sheet for the liquids used must be affixed to each device.
- Metal accessories such as probes or standard horns should be decontaminated and disposed of as metal waste.
- The packing is recyclable.

# 10 Keyword index

## A

Accessories	3, 6, 12, 14, 30, 35, 36
Ambient conditions	9, 10
Amplitude	7, 8, 16, 17, 20, 21, 22, 24, 27
Amplitude settings range:	8, 19, 23

## B

Bar graph	20
Booster horn	6, 7, 12, 14, 24, 25, 26, 27, 28, 30, 37
Button	6, 8, 10, 16, 18, 20

## C

Calibration	31
Cleaning	29, 30
Contamination	22, 30
Continuous operation	8, 16, 17, 19

## D

Damage	8, 12, 13, 14, 22, 29
Decontamination	35
Default value	16, 17, 19
Degree of protection	8, 10
Disassembly	12, 13, 24, 25, 26, 27
Disinfection	30

## E

Earthed socket	12, 14, 15
Energy	7, 20
Error message	15, 19, 31, 32
Examples of uses:	7

## F

Faults	13, 31, 32, 33
Foot switch	8, 10
Frequency (ultrasonic)	7, 8, 10, 19, 31
Function testing	9, 31

## G

Guidelines	7
------------	---

## H

Hearing protection	3, 12
Homogeniser	6, 7, 8, 9, 12, 13, 16, 21, 22, 29, 30, 31, 35, 37
Housing	12, 13, 14, 28, 29, 32
Hygiene	12
Hygiene plan	30

## I

Intended use	7, 9
--------------	------

## L

Laboratory field	13
Liquid	7, 12, 13, 21

## M

Mains voltage	12, 14, 34
Maintenance	29
Maintenance service	35
Manufacturer	3, 7, 13, 31, 35
Medical field	13, 30
Medical product	7, 9
Menu	15, 16, 19
Micro-organisms	7, 30
Micro tip	7, 12, 21, 26, 30
Mounting	8, 12, 13, 14, 24, 25, 26, 27, 28
Mounting surface	24, 25, 26, 28, 34

## O

Operating element	8, 10, 12, 15
Operating mode	8, 11
Operating parameters	15, 16, 17, 20
Operation	8, 9, 11, 12, 13, 16, 29

## P

Piezo elements	14
Preparation of samples	7
Probe exchange	8, 19
Probes	7, 8, 12, 13, 14, 15, 16, 21, 22, 23, 24, 26, 29, 31, 33, 34
Product features	6
Product information	3, 23, 28
Protection class	8
Pulsation time	8, 16

## R

Rated ultrasonic output:	8
Reconditioning (probe)	29
Remote control	10
Remote control sleeve	6, 10
Remote operation	8, 10
Repair	13, 31, 32, 35
Repair service	35
Resonance frequency	8, 19, 34
Rotary knob	8, 15, 16, 19, 20
Rotational direction	25, 26

## S

Sample quantities	12, 22
Scope of delivery	3, 14, 24
Serial number	6, 7, 9
Service	35
Servicing	31
Sickle spanner	25, 26, 27, 28
Signal	10
Signal input	11, 12
Signal line	12
Signal output	12
Skilled personnel	13, 32
Solvents	12, 21
Sonicated volume	21, 23
Sonicated medium	7, 21, 22, 31
Sonication	12, 17, 21, 22
Sonication time	16, 17, 20
Sonication vessel	12, 21
Sound proof box	12, 14, 36
Spanner	25, 26
Splashing risk	12, 22
Standard horn	6, 7, 12, 14, 23, 24, 25, 26, 27, 28, 30, 37
Startup	9, 12, 15
Suitable for continuous operation	10
Surface (sound-emitting)	22, 29, 30, 31

## T

Tapered tip	7, 12, 21, 26, 30
Technical data	8, 10
Temperature sensor	12, 22
Threaded bolts	28, 34
Titanium plate	7, 12, 25, 29, 30, 34
Tool	13, 24, 34
Type plate	6, 9, 14

## U

Ultrasonic amplitude	7
Ultrasonic connector	6, 14
Ultrasonic frequency	19
Ultrasonic generator	6, 7, 8, 12, 14, 15, 16, 19, 21, 24, 27, 29, 33
Ultrasonic operation	8, 10, 11, 17, 18, 20
Ultrasonic output	15, 22
Ultrasonic transducer	6, 7, 8, 10, 12, 13, 14, 15, 18, 19, 20, 21, 22, 24, 27, 28, 30, 31, 32, 33, 34, 37
Use	3, 13, 33

## V





Viscosity	8, 20, 21
Voltage source	11, 12



## A Tools for mounting/dismounting

Probes, standard horns and booster horns are highly-sensitive parts that must be mounted and dismantled with the greatest care.

For this reason, only use the following keys for mounting/dismounting of probes from standard or booster horns, as well as of standard or booster horns from the ultrasonic transducer:

Spanner Type	Usage
Spanner MS 10, long 	In order to mount/ dismount probes and probe extension VS 70
Spanner MS 22 	To mount/dismount titanium plates TT 25 SW 17 for VS 190 T SW 22 for TT 25, VS 200, VS 200 T
Sickle spanner HS 40/42 	To mount/dismount all probes (used to hold the standard or booster horn firmly in place)
Sickle spanner HS 40/42, long 	For mounting/dismounting of standard and/or booster horns from the ultrasonic transducer
Torque Wrench DMS 10 	Code No. : 3662

**Please note:**

The user instructions in this and other languages, as well as further information, can be found on the enclosed CD.