

ESCO®

Labculture® Class II Type A2 Biohazard Safety Cabinet



Class II Design: Personnel, Product / Sample, Environment Protection

US Standard NSF49 and European Standard EN12469 Tested

Safe: Mini-pleated ULPA Filtration for >99.9997% Typical Efficiency at MPPS

Easy to Use: Microprocessor-Based Control and Alarm System

Less Maintenance: Automatic Airflow Compensation

Comfortable: Ergonomic 10 Degree Sloped Front

Built-in-Protection: Anti-Microbial Coated Cabinet Structure

At Esco, **your safety means the world to us**. And this vision finds fulfilment in the **Esco Labculture® Class II Type A2 Biohazard Safety Cabinet**.

The Esco Labculture® Class II Type A2 Biohazard Safety Cabinet combines Esco's experience of more than 20 years in safety cabinet technology. The design is an optimum combination of safety, performance, serviceability and ergonomic factors.

Learn about the unique features that make this model a choice for the modern laboratory.

This cabinet is designed to protect:

a. The user from exposure to biologically hazardous aerosols / particulates generated within the work zone

NB: This cabinet does not offer protection against chemical fumes and vapours unless exhausted with the optional thimble, and when these compounds are used in trace amounts.

b. The product / samples / processes inside the cabinet from ambient contamination present in room air

c. Against cross contamination between different samples in the work zone

The Labculture® Class II Type A2 cabinet is designed to meet the operating principles and performance criteria:

a. For Class II Type A2 cabinets as defined in the **US Standard ANSI/NSF49** ("Class II (Laminar Flow) Biosafety Cabinetry": 2002)

b. For Class II cabinets as defined in the **European Standard EN12469** ("Performance Criteria for Microbiological Safety Cabinets": 2000)

c. For Class II Type A/B3 cabinets as defined in the **Japanese Industrial Standard JIS K3800** ("Class II Biological Safety Cabinets": 2000)

d. For Class II cabinets as defined in the **South African Standard SABS VC 8041:2001** ("Compulsory Specification for Biological safety cabinets (Classes I, II and III)": 2001)

e. For Class II cabinets as defined in:
(Below standards are now obsolete and have been replaced by the harmonized European Standard EN12469)

British Standard BS5726 ("Microbiological Safety Cabinets: Part 1. Specification for design, construction and performance prior to installation": 1992)

German Standard DIN12950 Teil 10 ("Laboreinrichtungen Sicherheitswerkbänke für mikrobiologische und biotechnologische Arbeiten: Anforderungen & Prüfung": 1992)

French Standard NF X44-201:1984 ("Postes de sécurité microbiologique": 1984).

The Labculture® cabinet has been independently certified / type-tested to the following international standards:

a. NSF49 certification in the USA

b. EN12469 type-tests in Europe

(Health Protection Agency, Porton Down, UK)

c. UL listed for USA and Canada

The cabinet is equipped with **two minipleat Ultra Low Air Penetration (ULPA) filters**, which operate at a **typical**



efficiency of 99.9998% at 0.3 & 0.12 microns and 99.9997% at MPPS. These filters provide a **higher level of personnel, product and cross contamination protection** as compared to conventional HEPA filters (99.99% efficient).

A microprocessor based control system allows the user to easily access all control and safety functions. The microprocessor system also monitors cabinet airflow via a temperature-compensated air velocity sensor, as well as front sash position sensors. Audible and visual alarms prompt the user in case of any unsafe condition.

The cabinet's airflow is self-regulating: the motor / blower system is able to compensate automatically to maintain airflow as the filter is loaded with particulates.

The unique 10-degree sloped front ensures maximum operator comfort by allowing more reach with less strain into the working area. The angle also greatly reduces glare and reflection in the front window. This promotes a more neutral working posture, less fatigue, and therefore better safety.

The Labculture® Class II Type A2 Biohazard Safety Cabinet is also the **first in the world to incorporate an anti-microbial coating for the entire structure of the cabinet**. This coating provides continuous protection against surface contamination and improves user safety.

The laminated glass sliding front sash is shatter-proof and provides greater operator protection.

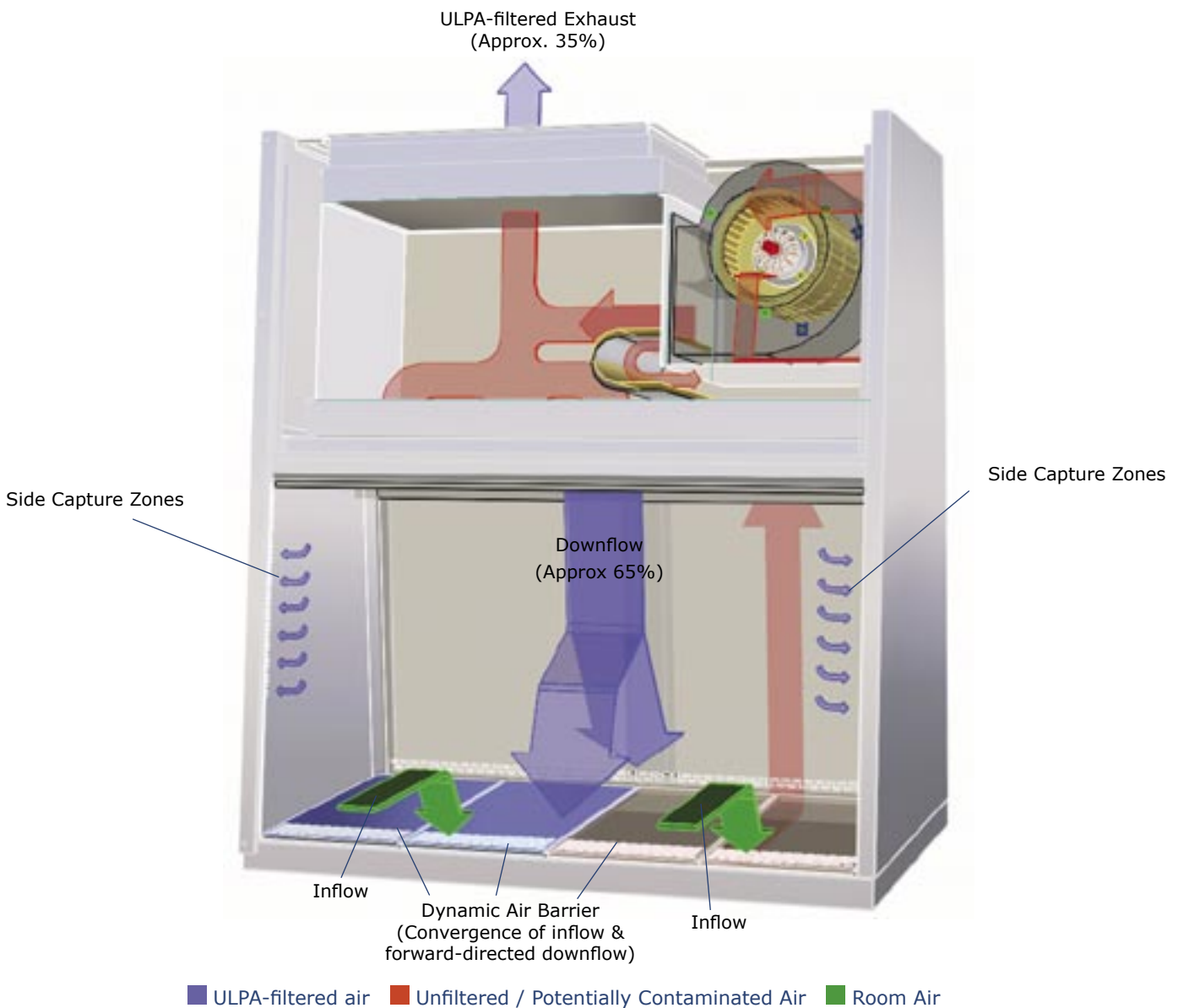

Class II cabinets provide product, operator and environment protection. They are suitable for general microbiological work with agents assigned to biosafety levels 1, 2, or 3. *Class II cabinets are recommended for most applications and are the most common and cost-effective systems available on the market today.*

The inflow moves from the room into perforations located towards the front of the work zone (in order to prevent contamination of the product, the inflow does not mix with the clean air present in the actual work zone of the cabinet), and then travels through an air return path below the work surface.

An ULPA-filtered vertical laminar flow air stream within the cabinet (also referred to as the downflow - *large light blue arrows on the airflow diagram*) moves downwards from the top of the work zone towards the work surface. A filter mounted in the ceiling of the working area provides this airflow and ensure the work zone is continuously

"bathed" in clean air, therefore protecting the product / samples in the work zone from contamination present in normal room air.

The downflow is uniform - all velocity readings are within $\pm 20\%$ (or $\pm 0.08\text{m/s}$ or $\pm 16\text{fpm}$) of the average velocity. The uniform nature of the air stream ensures a high level of protection against cross-contamination between various samples placed at different locations within the cabinet work zone.

Close to the work surface, the downflow air stream splits with a portion moving forward and entering the front air grille, and the remainder moving backward towards the back air grille. In addition, a small portion of the filtered downflow air enters the airflow intake perforations referred to as *side capture zones* at the front of the side walls at high velocities (*indicated on the diagram with small blue arrows*). This forms an air barrier that ensures no contaminated air enters the actual work zone, and also prevents any contamination from escaping

the cabinet. Combined with the inflow, air is moved within the cabinet, through an air return path (underneath the work surface, and behind the back wall) to a plenum in which the blower system is mounted.

From the common air plenum, approximately 35% of the air is ULPA-filtered and exhausted (thus protecting the operator and the environment from exposure to biological hazards), while approximately 65% is ULPA-filtered and recirculated into the work zone as downflow.

When remotely exhausted to the external atmosphere via a non-airtight thimble connection (*optional*), the cabinet provides protection for the operator from volatile toxic chemicals used in trace amounts, which normally would not be removed by the exhaust ULPA filter.

**In accordance with NSF49 requirements, the cabinet shall be connected via a non-airtight, thimble connection.*

Cabinet Airflow

Permanently lubricated direct drive centrifugal blower(s); energy efficient external rotor type design reduces operating costs; the horizontal blower mounting design avoids direct filter pressure and guarantees better airflow uniformity.

Precisely engineered airflow. An externally adjustable damper allows easy balancing. The state-of-the-art, microprocessor controlled Esco Sentinel Control™ monitors all critical cabinet airflow parameters and alerts the operator through audible / visual alarms in case of any malfunction. Airflow sensors employed are also temperature-compensated. **The downflow filter is also angled to deliver better uniformity over the work zone.**

Aerodynamically designed front airflow intake zone eliminates turbulence and the possibility of loss of containment.



Potential air leakages are prevented by the **enhanced side capture zones** between sidewalls and the work tray.

User / Ergonomic Features

Depth of front air grille is minimized to bring the workzone closer to the user and thus, improve reach.

The sleek, ergonomically styled 10-degree sloped front eliminates glare and increases operator-reach into work zone with less physical strain. The frameless UV-resistant laminated glass sash enables maximum visibility without causing uncomfortable glare. In addition, the 5000k colour temp fluorescent lighting system is used for less glare and greater operator comfort.

A large 229 mm / 9 inch (259 mm / 10 inch, measured from work surface) work access opening allows easier access into the work zone. (NB: For 3ft & 6ft models, work access opening is 203 mm / 8 inch. Refer to engineering diagram on page 11 for illustration)

The counterbalanced, laminated safety glass sash is frameless for maximum visibility into the work zone and easy cleaning

(no joints for contamination to accumulate in). The front sash can also be closed fully to keep the cabinet interior clean during periods of non-use as well as to prevent exposure to UV radiation.

In addition, the position of the laminated safety glass window, monitored by the cabinet control system, has to be in the fully closed position before the UV lamp will activate.



Service fixture provisions are offset and staggered for easier reach and access to service fixtures. Standard Esco cabinet comes with two service fixture provisions on each sidewall of the cabinet.

2 optional electrical outlet provisions are provided on the sidewalls (one on each wall) for easier reach instead of on the backwall.

Cleanability

Attractive single-piece stainless steel inner liner means the interior workzone of the cabinet is easy to clean and does not have any crevices or joints for potential contaminants to collect. Work tray edges are radiused for better containment and easy cleaning.



Lower drain spillage trough is fabricated in one single-piece, thus eliminating any joints that could potentially result in the leakage of contaminated liquids. The trough has wide-open angles (superior to radii) for maximum cleanability.

The sidewall is closed which enhances cleanability - there are no perforations, air return slots, or hard to reach hidden areas

where contaminants can accumulate. Especially unique is the single joint between the side wall liners and the lower drain pan which is sealed rather than left open as is usually the case with other designs.

The sash track may be easily disassembled to allow cleaning behind the sash.

No screws are present on the front and sides of the cabinet, inside the work zone, and below the work surface in the drain pan, thus making the entire assembly visually appealing and all exterior and interior surfaces easy to clean.

Safety Features

Inherently safe design maintains containment for protection even with some or all work trays removed*, thus preventing hazardous exposure during cleaning and maintenance.

**Standard work surface is single-piece. Multiple piece worktrays are available on request.*

Top of the cabinet is sloped to prevent objects from being placed on top and also to ensure that the exhaust airflow is not blocked or compromised by a low-height laboratory ceiling.

Front armrest is raised above the air grille perforations to prevent the operator's arms from blocking air inflow during usage. In addition, front perforations are curved to prevent users from placing any objects on the grille itself.



Germicidal UV lamp (optional) is placed behind the front panel and out of operator's direct line of sight** to ensure maximum operator safety and comfort. Front sash window must be fully closed before UV lamp feature is activated.

***For 3, 4 and 5 ft models*

A conveniently accessible paper-catch is integrated in the air return area in order to prevent wipes and small items from entering the blower.

Electrical System

The electrical system of the cabinet has been designed in accordance with the requirements of the following standards: IEC 61010-1, EN 61010-1, UL 3101-1 and CSA C22.2 No. 1010.1-92. All components are UL-listed or recognised.

Accessibility for service: all electrical services are behind the front panel, meaning less reach, for example, to the top of the cabinet (where other manufacturers locate the electric and electronics).

Minimal downtime: all maintenance can be performed from the front of the cabinet thus eliminating the need for the unit to be physically relocated or disconnected from service connections. Complete isolation of all cabinet components (except the ULPA filters and the blower) from contaminated spaces means that maintenance can be performed safely without the need for time-consuming and costly fumigation / chemical decontamination.

Servicing your cabinet is a breeze with Esco's unique hinged maintenance panel. Simply remove the fasteners at both sides of the panel, lift it up, and mount it on struts, which are self-supporting via gas springs in the open position. The fluorescent lamps (mounted out of the air stream for perfect airflow uniformity), electrical components, electronic boards, display and keyswitch are mounted behind this panel.



The modular electrical system can be replaced quickly with snap-together connectors in case of any electrical fault, thus reducing downtime.

The warm white fluorescent lighting is electronically ballasted for lower heat output, higher energy efficiency, and zero-flicker (as compared to conventional electromagnetic ballasts).

All cabinet electrical systems, with the exception of the fan motors, are located outside contaminated areas and can be accessed without the need for decontamination. All electrical penetrations into and out of contaminated areas are meticulously sealed and pressure-tested at the factory.

For filter and blower maintenance, remove the access cover (secured and gasketed to the cabinet carcass) mounted

on the front of the cabinet. Notice the lifting grip provisions that allow this cover to be removed with minimal physical effort. Your service provider can then access the internal plenum for filter replacement and blower maintenance.

The housing of this plenum is designed to allow easy access for maintenance. The unique telescoping design eliminates the need for physical lifting and enables filter replacements to be completed with less manpower, time and effort.

Most removable components can be removed without tools; a convenient tool kit is supplied with every cabinet with extra fasteners, misc. hardware and common hand tools required for service.

Cabinet is shipped fully assembled in the crate and is easy to install. A standard unit can be lifted directly off pallet. Simply plug the unit into a power source for operation - no local installation is required; 10 different international plug types are available.

Esco is dedicated to providing all our users with a high level of service both at the time of purchase and throughout the entire life-time of the product. Other enhanced services are available both directly from Esco and / or through most Esco distributors including on-site testing / installation, annual maintenance / recertification, extended warranty service.

Dynamic Chamber™ plenum design surrounds contaminated areas with negative pressure plenums, thus preventing possible leakages of filter seal, gasket and cabinet carcass.

The Labculture® Class II Type A2 biosafety cabinet provides the user with maximum safety with its **unique double-walled design**. Thus, **the cabinet sidewall is under negative pressure**. This means, as a system, the cabinet is inherently safe. Even in the event both internal and external walls are punctured, there will be no leakage of contamination from the cabinet. Single wall designs employed by many other brands can result in safety hazards if seals fail, as air will flow from the outside environment (higher pressure) to the lower pressure shell of the cabinet.

■ Positive Pressure

■ Negative Pressure



Stringent Performance Testing at Esco

Each individual unit shipped is extensively tested for performance and safety and delivered with a detailed test report and certificate of performance. Every single Labculture® Class II Type A2 cabinet manufactured is tested and validated with the following test methods:



- a. Inflow / downflow velocity tests
- b. PAO Aerosol challenge test for filter integrity
- c. Light / noise / vibration tests
- d. Airflow pattern visualisation test
- e. Electrical safety to IEC61010-1
- f. **KI-Discus Containment Testing** (for further information, refer to pg.10 of this catalogue)
- g. **Microbiological testing** performed on statistical sampling basis (for further information, refer to pg. 9)

Esco performs testing in accordance with more than 20 of the world's most recognized standards, of local, regional and international scopes. In particular, testing in our laboratory is most frequently conducted based on: EN12469, NSF49 and IEST RP. An NSF-Accredited Biohazard Cabinet Field Certifier is available in-house full-time to supervise all testing work.

Esco Sentinel™ Microprocessor Control System

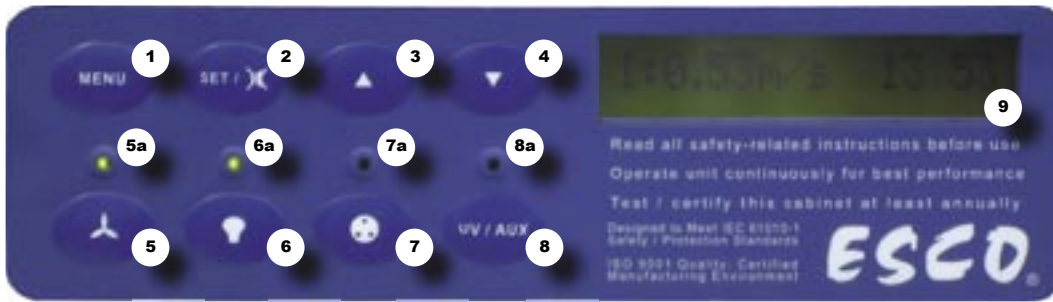

Sentinel™ Control System

1. Menu Button
2. Set or Mute Button
3. Scroll-up Button
4. Scroll-down Button
5. Fan Button
- 5a. Fan indicator
6. Light Button
- 6a. Light Indicator
7. Socket Button
- 7a. Socket Indicator
8. UV Light / Auxiliary Button
- 8a. UV Light / Auxiliary Indicator
9. LCD Screen

Esco's Sentinel™ microprocessor cabinet control system is designed to optimize the usage of our biosafety cabinets. Combining user-friendly features with the most advanced technology, the embedded control provides you with the best product performance.

Operational Features

- ▶ True airflow velocity (both for downflow and inflow velocity) sensing technology, with temperature compensation for improved sensor accuracy.
- ▶ Continuous digital display of inflow and downflow velocities on the front LCD for constant monitoring.
- ▶ Automatic pre-purge cycle at start-up requires a fixed period of warm-up period during which the cabinet workzone is purged of contaminants before use. All features are disabled until the cabinet is warmed up and activated, thus preventing any inexperienced personnel from performing operation.
- ▶ Configurable post-purge cycle ensures all residue contaminants are purged out of the cabinet workzone before the cabinet is deactivated.
- ▶ Intelligent diagnostics of hardware problems with error message reports.
- ▶ All cabinet operating parameters can be customised and configured based on the requirements of the user.
- ▶ UV timer function to control the decontamination cycle and maximize lamp life (the UV timer is programmable and will shut off the lamp after the desired period of decontamination).
- ▶ Air-velocity (both inflow and downflow) can be displayed in either fpm or m/s
- ▶ Built-in 24hr clock and experiment timer display for monitoring the duration of experiments and processes.

- ▶ Ambient temperature display both in Celsius and Fahrenheit.

Security Features

- ▶ Fail-safe control system equipped with a watchdog timer ensures the cabinet safety is not compromised even if the electronics hardware fails. In case of failure, the control will automatically reset the system and restore the cabinet to safe settings.
- ▶ An Admin PIN can be set by the laboratory supervisor to restrict access to all menu functions.
- ▶ A Fan PIN feature allows the supervisor to restrict access to fan control, thereby preventing usage of the cabinet by unauthorized personnel.

Safety Features

- ▶ Audible and visual alarms for low airflow, unsafe sash positions.
- ▶ Mute function with automatic 5 minute ring-back when sash is fully opened, for cleaning purposes.
- ▶ Sash alarm is activated and the light is automatically cut off when the sash is lower or higher than standard operation height, in order to restrict the user's operation, thus enhance safety.
- ▶ While all functions can be accessed on the control panel, an RS232 interface to PC program for diagnostics, software updates and parameter settings is also available. Your investment is protected: The Sentinel™ control software may be updated by downloading update patches from the Esco Biotech web site.
- ▶ Microprocessor control software can be customized upon request to fit the user's requirements.

Ergonomic Features

- ▶ Control panel is sloped downwards to provide the operator (in a sitting position) a better view of and an easier access to the controls.



- ▶ Easy-to-clean touch controls equipped with a tactile mechanism.
- ▶ Large, generously sized backlit LCD.

Maintenance Features

- ▶ A Blower Hour Meter helps you monitor total cabinet usage time, gauge the life of HEPA/ULPA filter and estimate as to when replacements are needed.
- ▶ An UV Hour Meter to monitor the total usage time of UV lamp and estimate the need for lamp replacement.
- ▶ Airflow calibration can be done easily using the microprocessor control on the front panel of the cabinet.
- ▶ The special **Maintenance mode** for servicing purposes, allows for by-pass of the cabinet presets and complete control over the cabinet's functions. All system interlocks are disabled, and all raw inputs and outputs can be viewed for troubleshooting purposes. (For authorized service personnel only. Consult manual before activation).

Filtration Agents

Esco Biotech's laminar flow and biohazard safety cabinets utilize the **latest mini-pleat separatorless HEPA/ULPA filter technology**.*

The ULPA filter, used in Esco Labculture® Class II Type A2 Biohazard Safety Cabinets, is **constructed of pleated borosilicate glass fibers which are glued into an aluminium frame**.

The aluminium frame is gasketed to form the final filter assembly with a **single-piece gasket*** that reduces the possibility of leakage / gasket damage.

The numerous advantages of the mini-pleat separatorless filter technology over the conventional aluminium separator filter technology include:

- ▶ Compact size that contains more pleat per unit of filter surface area.
- ▶ Increased media area with more effective dust holding and longer filter life
- ▶ Aluminium frame that is lighter than the conventional wooden frame used in aluminium separator filter technologies. The aluminium frame also eliminates the possibility of swelling in moist conditions present with conventional wooden-frames.
- ▶ Eliminates the possibility of filter damage by aluminium separators

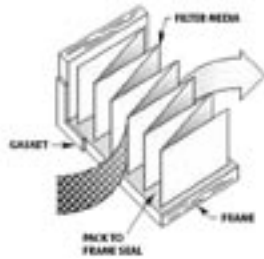

**Mini-pleat
Separatorless Filter**

VS.



**Conventional
Aluminium Separator Filter**

*only for Camfil® filters

Superior-Efficiency ULPA filters

Esco Biotech cabinets use **ULPA filters** (Ultra Low Penetration Air), a superior filter type to the conventional HEPA (High Efficiency Particulate Air) filters used by most other manufacturers. While HEPA filters provide 99.99% typical efficiency at 0.3 micron level, ULPA filters provide 99.9998% typical efficiency at 0.3 & 0.12 micron levels and 99.9997% at MPPS (Most Penetrating Particle Size).

ULPA Filter Efficiency Graph

(%) Maximum and Typical Penetration

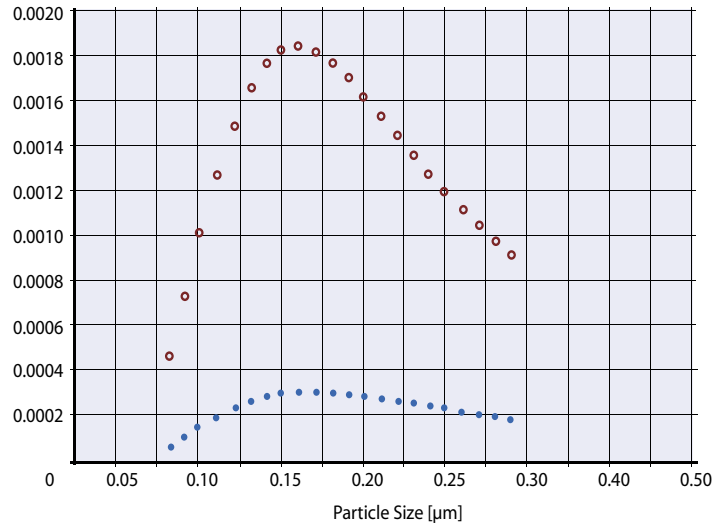

○ Maximum Penetration ● Typical Penetration

ULPA filters are used on all Esco Labculture® and Airstream® laminar flow and biohazard safety cabinets, which offer **ISO Class 3 air cleanliness within workzone as per ISO 14644.1** (Class 1 as per the former US Federal Standard 209E, 100 times "cleaner" than cabinets offered by most manufacturers on the market).

Esco Labculture® and Airstream® range clean-air containment cabinets use HEPA/ULPA filters by **Camfil Farr®**, headquartered in Sweden, one of the leading global manufacturers of filters and clean-air solutions.

Fan / Blowers used in Esco Safety Cabinets

Esco Labculture® Class II Type A2 biosafety cabinets utilize permanently lubricated centrifugal external-rotor motor blowers from **ebmpapst**, manufacturer of innovative fan and motor technology headquartered in Germany.

External rotor-motor designs are known for their compact and flat build and energy-efficiency. Due to the fact that the external-rotor motor is integrated in the impeller, the design allows for optimum cooling of the motor (see illustration below).

All rotating parts are directly fitted to one component and dynamically balanced as such. Total weight is equally distributed to both bearings.

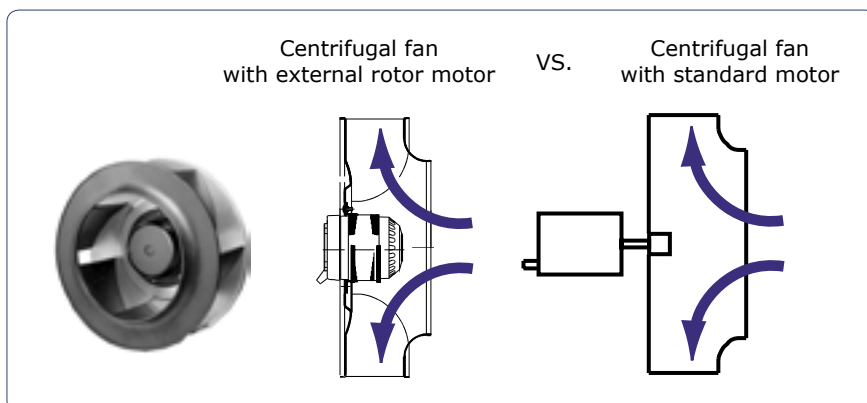

ebmpapst

The main advantages of the ebmpapst external-rotor motor design include:

Compact and low-noise construction (fan blades are attached directly to the outside of the rotor)

Superior dynamically balanced design

Perfect bearing alignment

100% speed control

Optimum heat transfer out of motor leading to less stress to the insulation system

Longer bearing service life

BioCote® Anti-microbial Powder-coating

Esco Biotech is the first manufacturer of biohazard safety cabinets in the world to offer **BioCote®'s anti-microbial powder-coating** on our Labculture® Class II Type A2 biosafety cabinet range.

As part of Esco Biotech's continuous efforts to improve our products, BioCote® anti-microbial powder-coating adds an additional safety dimension to our containment cabinets by minimising microbial contamination and inhibiting bacterial growth within internal cabinet areas thus enhancing operator and product protection.

The anti-microbial powder-coating also minimises the risk of cross-contamination via cabinet surfaces during regular usage.

NB: BioCote® surfaces are not a replacement for good cleaning practices.

The active ingredient in BioCote anti-microbial powder-coating is the element silver in the form of silver ions, an agent extremely

effective against a wide range of micro-organisms and with low toxicity against non-target organisms. Silver ions in the powder-coating bind to cells in micro-organisms and effectively interrupt their critical functioning, thus inhibiting growth of potentially hazardous bacteria, mould and fungi.



BioCote® has been tested to be effective against the following examples of bacteria:

- Staphylococcus Aureus (including MRSA)
- Escherichia Coli (E-Coli)
- Listeria Monocytogenes
- Streptococcus faecalis
- Salmonella enteritides
- Aspergillus Niger (Black Mould)

As BioCote® is built into the powder-coating applied to the steel shell of the cabinet, its effectiveness lasts throughout the lifetime of the product, and does not wash out or is removed by cleaning.

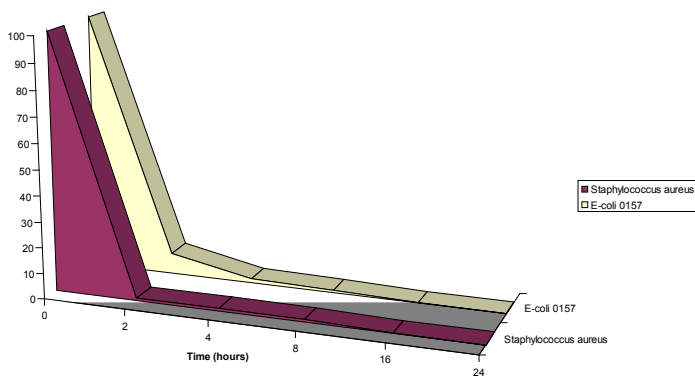

Sample Test Results - Test Reduction against control samples

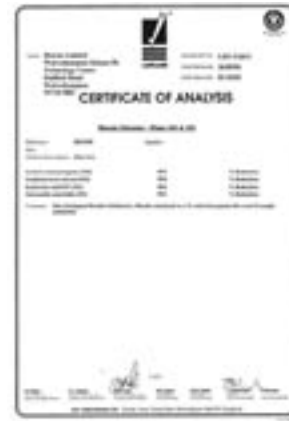

Laminated Safety Glass

At Esco, we take extra care to ensure that every aspect of our products provides our customers with maximum safety and optimum performance. In addition to the many safety features incorporated into the Labculture® cabinet design, Esco equips its cabinets with the safest and most reliable components available on the market.

Esco Labculture® Class II Type A2 biosafety cabinets are equipped with a **laminated safety glass front sash** for extra safety.

The laminated glass used on the Labculture® cabinet is constructed of 2 layers of glass permanently bonded together by a tough and durable polyvinyl butyral (PVB) interlayer. When the glass is broken, the PVB layer holds the glass pieces together, preventing fragmentation. This feature serves two important purposes:

1. As the glass is held together, the air barrier that ensures personnel protection is not disrupted. This allows for a safe shutdown of the cabinet without compromising the cabinet's containment level, and thus operator safety.

2. Glass fragments and shards, which could potentially injure the operator, are held together by the adhesive PVB interlayer.

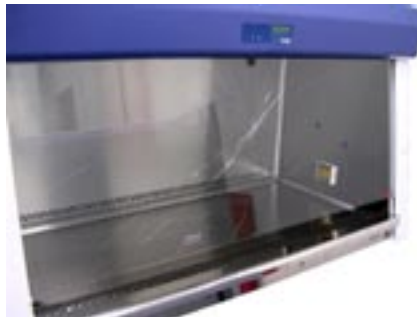

Other advantages of the laminated glass used in the Labculture® Class II Type A2 are:

The laminated glass has a higher tolerance to heat as compared to normal tempered glass, and is therefore less likely to shatter in case of fire within the cabinet. In addition, the PVB interlayer ensures a higher resistance to impacts and blows.

Higher optical quality and less reflection and glare off of glass surface, allowing for a clearer view into the cabinet workzone and less operator fatigue over extended usage.

Optimum resistance to and filtering of germicidal UV radiation. In UV mode, the laminated glass front sash provides complete protection to the operator from harmful UV rays.

The interlayer dampens sound significantly better than conventional glass and acts as an effective noise reduction feature.

The PVB interlayer on laminated glass used on the Esco Labculture® Class II Type A2 Biohazard Safety Cabinet is 0.76mm thick, providing better noise absorption and safety properties than 0.38mm interlayers which may be used by other cabinets equipped with laminated glass front sashes. Most biosafety cabinets offered by competition have tempered glass front sashes.

Microbiological Testing of Biohazard Safety Cabinets at Esco Biotech

Air velocity and air flow pattern visualisation tests are not sufficient to ensure safe cabinet performance. For example, two different cabinet designs may have the same airflow velocity settings but provide grossly different levels of protection. Cabinet performance is greatly influenced by other factors such as the geometry of the cabinet air intake openings, the height of the front access opening, and the shape / size of the interior work space.

For this reason, **microbiological challenge testing is defined in and required by all the international standards for safety cabinets** (NSF49, EN12469, etc.). These tests involve challenging the cabinet with bacterial aerosol of fixed characteristics. Sampling methods allow the performance of the cabinet to be evaluated. For example, in the personnel protection test, the bacterial aerosol is released inside the work zone of the cabinet close to the front. Samplers are then located outside the cabinet and the total number of colony forming units recovered is counted.

As part of Esco Biotech's Product Research and Development Department, **Esco's Microbiological Testing Laboratory performs microbiological testing of biosafety cabinets according to the international standards, ANSI/NSF49 and EN12469:2000.** The cabinet is challenged with harmless *Bacillus atrophaeus* (formerly *Bacillus subtilis*) bacteria during the following three tests designed to assess the containment/protection capability of the cabinet.

Increased microbiological challenge tests, with objects inside the cabinet work zone to simulate real-world conditions, are also conducted to assess the protection capability of the cabinet in the laboratory.

Personnel Protection Test

Personnel Protection Test evaluates the safety of the cabinet for the personnel operating on potentially hazardous samples in the cabinet workzone. A nebulizer containing 55 mL of 5 to 8 x 10⁸ spores/mL *B.atrophaeus* spores is placed inside the workzone behind the front opening sash. The bacteria is ejected at controlled pressure and slit samplers and impingers are placed outside the workzone to sample potential aerosol discharge. As with the other two tests, the collected sample is incubated for 48 hours and checked for presence of any bacterial growth or *B.atrophaeus* CFU.

Acceptance: The number of *B.atrophaeus* colony forming units CFU recovered from the agar plates shall not exceed 10 CFU per test.

Product Protection Test

Product Protection Test determines the cabinet's protection to the product/samples inside the cabinet workzone from environmental contaminants. With the entire work surface covered in agar plates as sampling surface, a nebulizer containing 55 mL of 5 to 8 x 10⁶ spores/mL, ejects *B.atrophaeus* aerosol at a controlled pressure into the cabinet workzone to simulate the presence of environmental/external contaminants.

A bacteria count performed after a 48-hour incubation period validates the effectiveness of the cabinet in providing optimum product protection in the workzone.

Acceptance: The number of *B.atrophaeus* colony forming units (CFU) recovered from the agar plates shall not exceed 5 CFU per test.

Cross Contamination Test

Cross Contamination Test evaluates the cabinet's capacity in ensuring that samples operated upon simultaneously inside the workzone will not cross contaminate.

A nebulizer containing 55 mL of spores (5 to 8 x 10⁴/mL) is placed inside the workzone, 3.0-5.0" (76-130mm) above the surface, against one of the sidewalls, and agar plates are placed under the nebulizer to sample bacteria spore viability and density, while a second group of agar plates are placed at a predetermined distance from the nebulizer to determine the cabinet's effectiveness in preventing cross-contamination.

The test is repeated with the nebulizer and the agar plates set up against the other sidewall of the cabinet. The agar plates are then collected and left to incubate for a period of up to 48 hours and checked for bacteria count.

Acceptance: The total number of *B.atrophaeus* CFU recovered on agar plates with centers greater than 36 cm (14") shall not exceed 2 CFU per test.



The Performance Envelope Concept

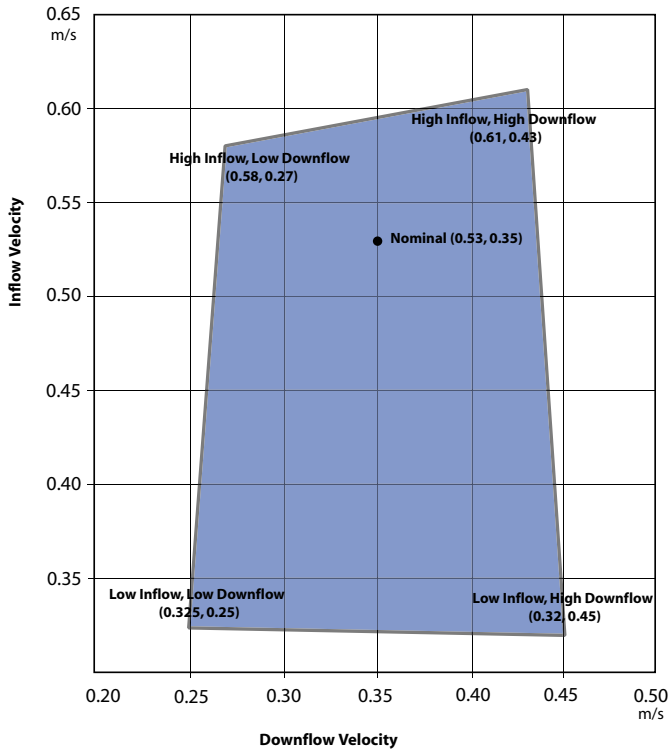

The table above illustrates the 4 extreme points of the performance envelope for the 4 foot model and their corresponding tests results obtained at the corresponding different setpoints.

In every Class II cabinet, two airflow parameters are the most critical for maximum personnel, product and cross contamination protection:

- **Inflow velocity:** the air stream entering the front access opening from the laboratory in which the cabinet is located.
- **Downflow velocity:** the filtered air stream within the cabinet which travels downwards from the work zone ceiling.

The following examples illustrate this:

- **High inflow:** operator protection may be increased since particles must have more energy to escape the work zone. However, product protection may be compromised since particles from outside have a higher chance of passing beyond the front air curtain and entering the work zone.
- **Low inflow:** similarly, operator protection may be decreased and product protection increased.
- **High downflow:** similarly, operator protection may be decreased and product / cross contamination protection may be increased.
- **Low downflow:** similarly, operator protection may be increased and product / cross contamination protection may be decreased.

Typically, microbiological challenge testing is only carried out at the cabinet's normal inflow and downflow setpoint. However, Esco Labculture® Class II Type A2 cabinets have been subjected to microbiological tests at alternative inflow and downflow settings. These tests allow Esco to define the "performance envelope" of the cabinet design - the range of inflow and downflow velocity settings under which the cabinet passed all microbiological tests (personnel protection, product protection and cross contamination protection).

With the performance envelope of the cabinet defined, Esco's R&D engineers selected a point in the approximate centre of the envelope as the inflow / downflow setpoint. This gives the cabinet a buffer of safety as inflow and downflow velocities may fluctuate in actual use.

All Esco cabinets are adjusted to the above inflow / downflow setpoint at the factory after production, and during all re-certification tests. The performance envelope concept and testing ensure maximum safety for the user and cabinet performance.

KI-Discus Containment Test according to EN12469:2000

The KI-Discus test is defined in the European Standard for microbiological safety cabinets, EN12469:2000, as a test method for validating the operator/personnel protection capabilities of the cabinet.

While the Microbiological Personnel Protection Test, described on page 9 of this catalogue, is an accurate indicator of the level of protection a safety cabinet is able to provide the operator, the KI-Discus test provides equally accurate results in a much shorter time span. While microbiological test samples are incubated for up to 48 hours before the results can be analysed, the KI-Discus test delivers the results within 15 minutes of beginning the test. Thus it is much more of a practical test method for field certifiers servicing laboratories in the real world.

The KI-discus test shows excellent correlation with the microbiological test method for operator protection. The KI-discus test is also extremely useful for validating the actual containment performance in-situ of the biological safety cabinet. Esco Biotech is currently the only company in Southeast Asia and one of the few in the world equipped to perform this test for customers of our microbiological safety cabinets.

Every single Esco Labculture® Class II Type A2 biosafety cabinet is tested using the KI-Discus method for containment and operator safety at the manufacturing site.



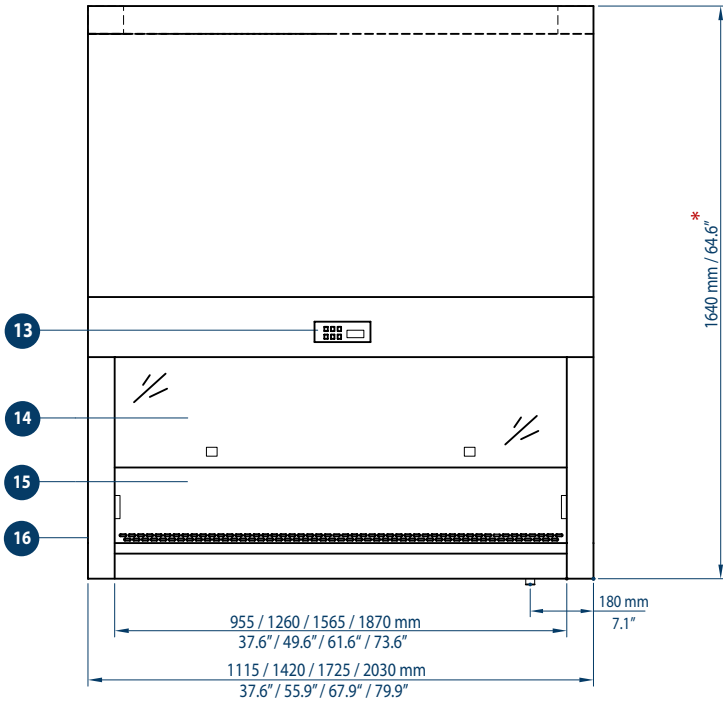

* REDUCED HEIGHT Series B:
External height: 60.6" / 1540 mm
Internal Workzone height: 26.4" / 670 mm

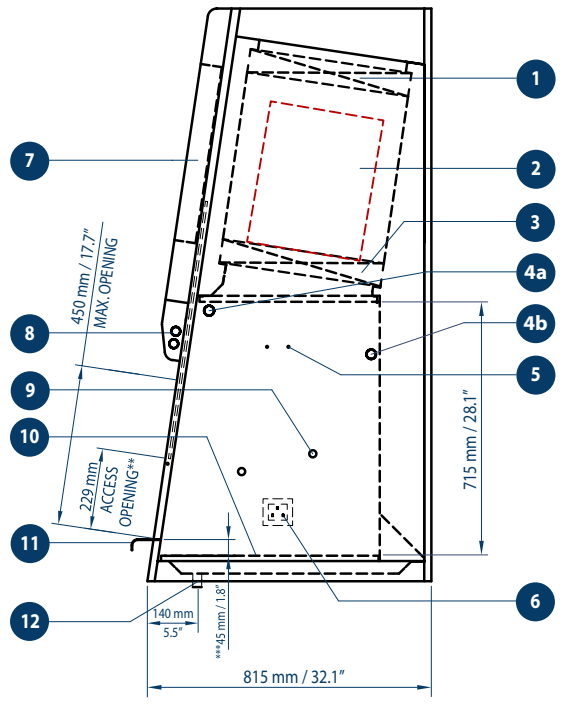

**ACCESS OPENING for LA2-3AX and LA2-6AX is 203 mm / 8"
***ARMREST POSITION for LA2-6AX is 33 mm / 1.3" from work surface level

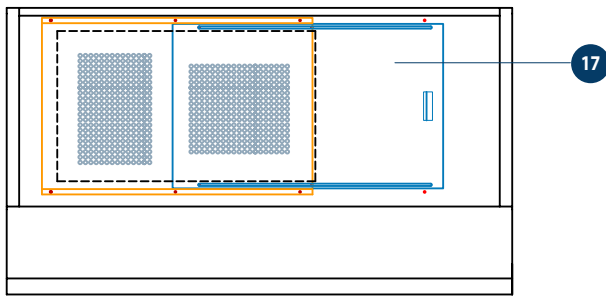

1. Exhaust ULPA Filter
2. Blower
3. Downflow ULPA Filter
- 4a. Standard UV Light Retrofit™ Kit Provision for 3, 4 & 5 ft models.
- 4b. Standard UV Light Retrofit™ Kit Provision for 6 ft models.
5. Standard IV-Bar Retrofit™ Kit Provision
6. Electrical Outlet Retrofit™ Kit Provision (3ft Model - One Single Outlet in Workzone) (4&6ft Model - Two Single Outlets in Workzone)
7. Electrical and Electronics Panel
8. Fluorescent Light
9. Plugged Service Fixture Provisions (2 on each side)
10. Stainless Steel Single-piece Work Tray
11. Stainless Steel Armrest
12. Drain Valve Retrofit™ Kit Provision
13. Esco Sentinel™ Microprocessor Control System
14. Laminated Glass Sliding Sash Window
15. Single-piece Stainless Steel Back Wall and Side Walls
16. Removable Side Panel for Plumbing Access
17. Exhaust Damper

Exhaust Collar Positions for Thimble-Ducting (Optional) of Labculture® Class II Type A2 Biosafety Cabinets

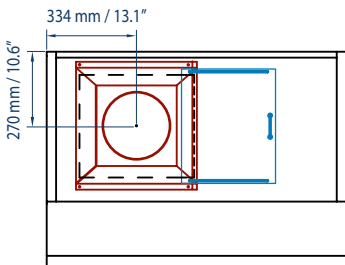

Top View - LA2-3AX

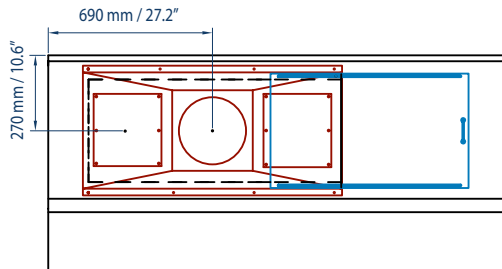

Top View - LA2-5AX

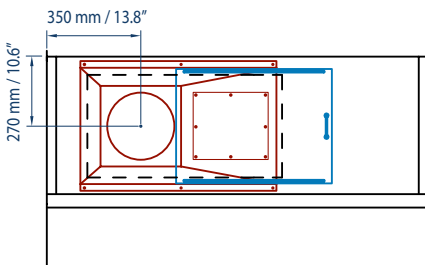

Top View - LA2-4AX

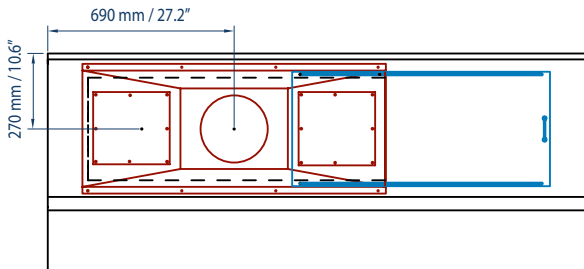

Top View - LA2-6AX

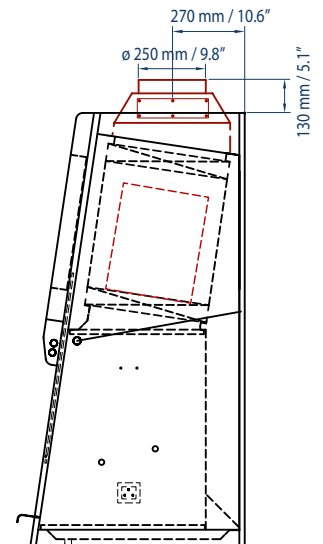

Side View - All Sizes

General Specifications		LA2-3AX	LA2-4AX <small>Standard Size</small>	LA2-5AX	LA2-6AX <small>Standard Size</small>
External Dimensions (L x W x H)		1115 x 815 x 1640 mm 43.9" x 32.1" x 64.6"	1420 x 815 x 1640 mm 55.9" x 32.1" x 64.6"	1725 x 815 x 1640 mm 67.9" x 32.1" x 64.6"	2030 x 815 x 1640 mm 79.9" x 32.1" x 64.6"
Internal Work Zone (L x W x H)		955 x 623 x 715 mm 37.6" x 24.5" x 28.1"	1260 x 623 x 715 mm 49.6" x 24.5" x 28.1"	1565 x 623 x 715 mm 61.6" x 24.5" x 28.1"	1870 x 623 x 715 mm 73.6" x 24.5" x 28.1"
Standards Compliance		NSF49 Certified, EN12469 Type-tested and UL-Listed for USA and Canada Air cleanliness: ISO 14644.1 Class 3, IEST-G-CC1001, IEST-G-CC1002 and other equivalent requirements Filter performance: IEST-RP-CC034.1, IEST-RP-CC007.1, IEST-RP-CC001.3 and EN1822 Electrical safety: IEC 61010-1 / EN 61010-1 / UL 61010A-1 / CSA C22.2 No. 1010.1-92			
Average Airflow Velocities	Inflow	Initial setpoint: 0.53 m/s or 105 fpm (audible / visual alarm will activate at 0.45m/s or 90fpm)			
	Downflow	Initial setpoint: 0.35 m/s or 69 fpm	Initial setpoint: 0.35 m/s or 70 fpm		Initial setpoint: 0.33 m/s or 65 fpm
		Uniformity is +/-20% or +/-0.08 m/s or 16fpm, whichever is higher			
Airflow Volumes At Initial Airflow Velocity Setpoints	Inflow	370 cmh / 217 cfm	545 cmh / 321 cfm	677 cmh / 398 cfm	724 cmh / 426 cfm
	Downflow (65%)	692 cmh / 407 cfm	913 cmh / 537 cfm	1134 cmh / 667 cfm	1277 cmh / 751 cfm
	Exhaust (35%)	370 cmh / 217 cfm	545 cmh / 321 cfm	677 cmh / 398 cfm	724 cmh / 476 cfm
Required Exhaust Volume with Thimble Exhaust Collar		517 cmh / 304 cfm	715 cmh / 421 cfm	847 cmh / 499 cfm	980 cmh / 577 cfm
Cleanliness Within Working Area		ISO14644.1 Class 3, US Federal Standard 209E Class 1 / M1.5, AS1386 Class 1.5, JIS B9920 Class 3, BS5295 Class C, Class M10,000 as per KS27030.1 and equivalent classes of VDI2083 and AFNOR X44101			
Downflow and Exhaust Filter Type		ULPA filter with integral metal guards and filter frame gaskets; fully compliant with EN 1822 and IEST-RP-CC001.3 requirements (each cabinet has individual downflow and exhaust filters)			
Filter Efficiency Ratings		Minimum: 99.9995% at 0.3µm / 99.9994% at 0.12µm / 99.9991% at MPPS Typical: 99.9998% at 0.3µm / 99.9998% at 0.12µm / 99.9997% at MPPS			
Noise Level	According to NSF49	<62 dBA	<63 dBA	<66 dBA	<67 dBA
	According to EN12469	<59 dBA	<60 dBA	<63 dBA	<64 dBA
	The above measurements were taken at initial blower speed setting (figures subject to acoustic properties of test environment)				
Light Intensity		>900 Lux / >84 foot candles	>1100 Lux / >102 foot candles		
		measured at work surface level (zero background) as per NSF49 test grid			
Maximum Usable Workzone Depth		510 mm / 20" (does not include the 110 mm / 4.3" front air grille)			
Maximum Usable Work Area (excludes front air grille)		0.49 sqm / 5.22 sqf	0.64 sqm / 6.89 sqf	0.80 sqm / 8.56 sqf	0.95 sqm / 10.22 sqf
Main Body Construction		1.5mmt / 0.06" / 16 gauge electro-galvanised steel with white oven-baked epoxy powder-coated finish			
Maximum Power Consumption / Current	220-240VAC / 50Hz 1Ph	890W / 3.87A	1595W / 6.93A	1615W / 7.02A	1631W / 7.09A
	110-130VAC / 60Hz 1Ph	884W / 7.37A	1630W / 13.6A	1650W / 14.3A	1666W / 13.88A
Heat Output (in British Thermal Units)	220-240VAC / 50Hz 1Ph	5396 BTU	5444 BTU	5512 BTU	5566 BTU
	110-130VAC / 60Hz 1Ph	5515 BTU	5563 BTU	5631 BTU	5686 BTU
Net Weight (Approximate)		275 kgs / 606 lbs	312 kgs / 688 lbs	365 kgs / 805 lbs	418 kgs / 922 lbs
Max Shipping Dimensions (L x W x H)		1265 x 950 x 1860 mm 49.8" x 37.4" x 73.2"	1570 x 950 x 1860 mm 61.8" x 37.4" x 73.2"	1875 x 950 x 1860 mm 73.8" x 37.4" x 73.2"	2180 x 950 x 1860 mm 85.8" x 37.4" x 73.2"
Max Shipping Volume		2.81 cbm / 99.2 cbf	3.49 cbm / 123.2 cbf	4.17 cbm / 147.3 cbf	4.85 cbm / 171.3 cbf

Optional Configurations:

1. Motorized Sliding Window 2. Reduced Height Series B: External height: 60.6" or 1540mm / Internal Workzone height: 26.4" or 670 mm

Ordering Codes for Esco Labculture® Class II Type A2 Biosafety Cabinet

Power Supply Options	Available Sizes			
	3 ft model	4 ft model	5 ft model	6 ft model
220-240VAC 50HZ, 1 phase	LA2-3A1 [#]	LA2-4A1 ^{#1}	LA2-5A1 [#]	LA2-6A1 [#]
110-130VAC 60HZ, 1 phase	LA2-3A2	LA2-4A2 ²	LA2-5A2	LA2-6A2 ²
220-240VAC 60HZ, 1 phase	LA2-3A3	LA2-4A3	LA2-5A3	LA2-6A3
110-130VAC 50HZ, 1 phase	LA2-3A4	LA2-4A4	LA2-5A4	LA2-6A4
100-110VAC 50HZ / 60HZ	LA2-3A5	LA2-4A5	LA2-5A5	LA2-6A5

[#]C-UL listed models

¹European Standard EN12469 Type-tested model

²NSF-listed models

Exhaust Collar for Thimble Ducting



- ▶ Exhaust collar for non-airtight thimble ducting of Esco Class II Type A2 cabinets.
- ▶ For exhausting trace amounts of volatile toxic chemicals from outside the lab

- ▶ Exhaust fan / ductwork not included
- ▶ White oven-baked powder-coated finish
- ▶ Available for all sizes (refer to diagrams on page 11)

Support Stand with Levelling Feet (Standard)



- ▶ Recommended for Biohazard safety cabinets: prevents the cabinet from being relocated/moved without authorization. Recertification of the cabinet is recommended every time the cabinet is relocated/moved.
- ▶ Heavy duty stainless steel legs

- ▶ Maximum weight supported: 500 kgs /1,100 lbs in total
- ▶ +/-1.5" / 38.1 mm adjustment range for each leg
- ▶ White oven-baked epoxy powder-coated finish
- ▶ Available in two standard sizes:
 - 29" / 737 mm (+/-1.5"/38.1 mm)
 - 33" / 838 mm (+/-1.5"/38.1 mm)
- ▶ Cabinet can be bolted on to stand for increased stability.

Hydraulic Support Stand



- ▶ Available in two versions:
 - Motorized electrically adjustable
 - Manually adjustable
- ▶ Adjustable height range: 710~863 mm / 28"~34"
- ▶ Maximum weight supported: 500 kgs / 1,100 lbs
- ▶ Available with:
 - castor wheels or levelling feet

- ▶ White oven-baked epoxy coating

Support Stand with Castor Wheels



- ▶ Durable polyurethane castor wheels with 360 degree horizontal rotation for convenient relocation and movement of a cabinet
- ▶ Total brake system on front wheels
- ▶ Maximum weight tolerance of 600kgs / 1323lbs in total
- ▶ Available for all standard cabinet sizes
- ▶ Available in two standard heights: 28" / 710mm and 34" / 860mm.

Telescopic Support Stand



- ▶ Recommended for Biohazard safety cabinets, as it prevents removal/relocation of a Biohazard safety cabinet without authorization.
- ▶ Adjustable height range: 26" - 37.8" / 660mm - 960mm
- ▶ Height is adjustable in 1" / 25.4 mm increments

- ▶ Support stand height is to be adjusted prior to the installation of the cabinet on to the support stand.
- ▶ Maximum weight tolerance of 600kgs / 1323lbs in total
- ▶ Available for 4ft / 1.2m and 6ft / 1.6m cabinet widths

PVC Armrest



- ▶ Chemically treated PVC.
- ▶ Soft padding enhances operator arm comfort during extended operations.
- ▶ Smooth surfaces without any contamination trapping pores or joints
- ▶ Non permanent, may be freely placed within the work zone and removed for decontamination
- ▶ Standard "one size fits all" design, Length: 712 mm / 28" ; Colour: Black

Ergonomic Labchair



- ▶ Designed for laboratory usage
- ▶ Meets cleanliness Class 100
- ▶ Alcohol resistant PVC
- ▶ Adjustable height to suit users of all heights
- ▶ Seat height range: 395~490 mm
- ▶ Caster wheels
- ▶ Attractive, chrome plated frame
- ▶ Chrome steel pipe leg
- ▶ Adjustable angle back rest
- ▶ Available in blue
- ▶ Can be disinfected with alcohol

Ergonomic footrest



- ▶ Provides lumbar support and encourages better user posture
- ▶ Adjustable height range: 10~30mm
- ▶ Floor mounted and free-standing.
- ▶ Angled footrest portion
- ▶ Anti-skid coating
- ▶ Solid steel frame finished in a chemically resistant powder coated finish

Electrical Socket Outlets

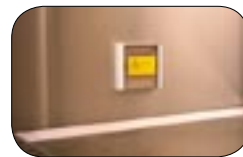

- ▶ Provides a convenient power source for small devices or equipment used within the cabinet
- ▶ Choice of 10 different types of socket available for different plug-types

Service Fixtures

- ▶ Convenient source for Gas/Vacuum/ Air/Water within the working area
- ▶ Available types:
 - A: American style; B: European style
 - ▶ European style fixtures manufactured according to DIN 12898, DIN 12919 and DIN 3537

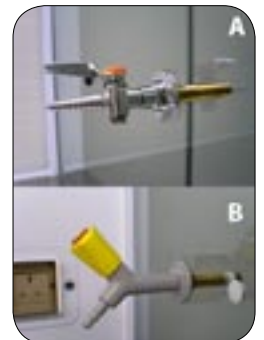

IV bar with hooks

- ▶ Stainless Steel IV bar with 6 hooks for IV-bags
- ▶ Available for all standard size Esco cabinets

Germicidal UV Lamp

- ▶ Provides germicidal sterilization of the cabinet interior
- ▶ Produces UV ray of 253.7 nanometers

Section I: General Requirements

1. The cabinet shall meet the performance requirements of the following:

- a. Class II Type A2 as per ANSI/NSF49 (USA)
- b. Class II as per EN12469 (European standard)
- c. Class II as per SABS VC 8041:2001 (South African standard)
- d. Class II as per JIS K 3800:2000 (Japanese standard)

2. The cabinet shall provide the following degrees of protection, validated for every cabinet on a statistical sampling basis based on the microbiological test methods from ANSI/NSF49 and EN12469.

- a. For the operator/laboratory environment against aerosols generated within the work zone
- b. For the product/processes within the work zone, against normal airborne contamination in ambient air
- c. Against cross contamination for different samples placed within the work zone

3. The operator protection factors shall be validated on every cabinet before shipment by the KI-Discus test method specified in EN 12469. The retention efficiency of the front aperture shall not be less than 99.999%.

4. The manufacturer shall individually test every cabinet before shipment. A test report shall be provided to the customer with a duplicate copy permanently attached to the cabinet. At a minimum, the following tests shall be performed:

- a. Inflow velocity via DIM (direct inflow measurement) method
- b. Downflow velocity and uniformity
- c. Filter leak scan with an aerosol challenge (individually, for both filters)
- d. Light/ noise/ vibration
- e. Electrical safety
- f. KI-discus (operator protection)
- g. Microbiological testing for operator, product, cross contamination protection on sampling basis

5. The manufacturer must be able to show evidence that the cabinet has been independently tested by any of the following approved bodies:

- a. HPA (Health Protection Agency, UK)
- b. NSF International (USA)

6. All 230VAC 50HZ models shall be CE marked.

7. The manufacturer must provide a comprehensive customer reference list of worldwide users.

Section II: Filtration System

1. The cabinet shall be equipped with the following particulate filters:

- a. One supply / downflow filter providing vertical unidirectional laminar flow inside the work zone
- b. One exhaust filter to cleanse the exhaust air

2. Both filters shall fulfil the following characteristics:

- a. ULPA (Ultra Low Penetration Air) type
- b. Minipleat separatorless style

c. Metal framed

d. Typical efficiency of 99.9997% at MPPS and 99.99998% 0.3 and 0.12 microns

e. Integral metal guard to prevent damage

f. Provided with handles for easy replacement

g. Scan-tested for leaks at time of manufacture

h. Scan-tested for leaks after assembly

onto the cabinet with an aerosol challenge

3. The filters shall be easily accessible for scan-testing in the field without accessing any potentially contaminated areas. A dedicated upstream sampling port shall be provided, accessible from within the cabinet, to facilitate filter scan-testing in the field.

Section III: Blower System

1. The cabinet shall be equipped with a direct-drive centrifugal blower, meeting the following requirements:

- a. Dynamically balanced as an assembly in two planes to ISO 2710
- b. External rotor type design
- c. An automatic thermal cut-out shall be provided to shut the blower down automatically in case it is overheated.

2. The blower system shall be designed for low noise, low vibration and maximum filter life.

3. The blower system shall be designed to automatically maintain cabinet airflow within +/-10 percent as the filters are loaded with particulate matter (150 percent of their original pressure loss). Test data to demonstrate this capability shall be available on request.

Section IV: Cabinet Control and Alarm System

1. The airflow alarm and control system shall be controlled using a microprocessor.

2. The cabinet shall be equipped with a soft touch keypad and continuously backlit LCD for controlling the operation of the fan, light, UV lamp, electrical outlet and microprocessor menu. For safety, the UV lamp shall be interlocked with the fan / fluorescent lights.

3. The cabinet shall be equipped with a monitoring system providing visual and audible alarms for any unsafe conditions (airflow, window position, and hardware errors). The alarms shall not be mutable except during cabinet start-up, cleaning (sash at maximum position) and when accessing special service functions.

4. Airflow shall be monitored with a thermistor-based true air velocity-sensing device mounted on the cabinet. The airflow display and alarm system shall be individually calibrated on the cabinet before shipment.

5. The control system shall also provide the following additional features:

- a. Automatic shutdown of the UV lamp via a timer to conserve lamp life
- b. Continuous display of air velocity on the LCD

c. Security control via a password for turning the blower on / off as well as separate password to secure all service functions

d. 24-hr clock display

e. Automatic pre-purge and post-purge cycles to ensure correct cabinet operation. The cabinet control system shall be locked during pre-purge warm-up period to prevent any usage.

f. An optional PC-based software program shall be available on request for performing field updating of the cabinet control system software via the Internet, as well as parameter setting.

Section V: Safety Features

1. All panels leading to potentially contaminated and / or dangerous areas shall be colour-coded red.

2. The glass used for the front window shall be laminated multi-layer safety glass.

3. The blower plenum shall be a permanent design constructed of steel.

4. The UV lamp, if installed, shall be mounted out of the operator's line of sight as an extra precaution.

5. A removable, perforated metal diffuser shall be installed below the downflow filter to ensure airflow uniformity inside the work zone as well as provide secondary protection against damage.

6. The cabinet shall be designed such that all contaminated plenums are under negative pressure or surrounded by negative pressure. There shall be no access points under positive pressure accessible external to the cabinet casing (for example, sampling ports, connection points).

7. The sides of the cabinet shall be of a triple wall design. Negative pressure shall be present within the first layer (stainless steel liner) and second layer (cabinet carcass). A third layer (external side dress panel) shall be installed for further protection.

8. All components, with the exception of the blowers and filters, shall be located outside of contaminated air spaces to facilitate service work without the need to decontaminate the cabinet.

9. The cabinet shall be designed with an externally accessible damper.

10. The cabinet shall be permanently marked with safety instructions clearly visible from the front.

11. The cabinet shall be designed to eliminate sharp edges, protrusions in order to minimize the risk of personal harm to the operator. All metal edges shall be dressed and deburred.

12. All electrical components shall be UL listed or recognized or certified to any other accepted international standard.

13. The cabinet shall meet UL 61010A-1 / IEC 61010-1, EN 61010-1, UL 3101-1 and CSA C22.2 No. 10101-92.

14. The cabinet shall meet the physical stability requirements specified in ANSI/NSF49 and IEC 61010.

A History of Clean Air Device Manufacturing Since 1978 ...

In 1978, Esco was founded to provide clean air solutions for the emerging high-tech industrial and life sciences industries. During those early years, our expertise with clean air technology was also applied towards the construction of laminar flow clean air devices.

Biohazard safety cabinets (today a core offering of Esco Biotech) and fume hoods were also designed and manufactured during the early 1980s, thus expanding the company's scope in the field of containment technology. That same period also saw the first exports of locally developed and proven clean air technology by Esco. In 1985, in-house sheet metal fabrication capabilities were established.

Eventually, the Biotechnology Equipment Division was formed to focus on the design and manufacturing of laminar flow, biohazard safety and other HEPA-filtered cabinets for the laboratory. Our unique background in industrial cleanroom and contamination control technology dif-



ferentiates us from our competitors who are solely laboratory equipment suppliers. The division draws from the broad base of resources of the group which is also engaged in other fields of clean air equipment technology.

Today, more than 20,000 Esco laminar flow, biohazard safety and other clean air cabinets are in use in the field with some installations dating back to the 1980s still in operation.

Esco supplies many high-tech industries with critical equipment that help keep prod-

ucts, people, and processes free from contamination. For example, our cleanroom construction components help pharmaceutical manufacturers meet GMP standards, keeping the drugs they produce clean. Our laminar flow mini-environments help microelectronics manufacturers increase product reliability and yields. In the laboratory, researchers use our safety cabinets for clinical biological research in order to develop vaccines for dangerous diseases. In a small way, Esco contributes towards these essential technologies that have become the backbone of our modern lives.

The Esco Biotechnology Equipment Division is a highly focused manufacturer of laminar flow, biohazard safety and other HEPA-filtered cabinets for the laboratory with a history of quality cabinets since 1978. We are predominantly oriented towards the international marketplace, with sales in more than 60 countries. A network of international distributors and partners allows us to provide quick and responsive local service and support.

Sophisticated Production Capabilities

Today, Esco's production capabilities for our laboratory equipment products are centralized in a 3,900 m² / 42,000 sq. ft facility separate from our Singapore corporate headquarters. This state-of-the-art fabrication centre houses the latest CNC (computer numerically controlled) sheet metal machinery and is highly automated to ensure that all products produced are of a high quality with less human intervention. An advanced powder-coating process is also operated in-house to ensure an aesthetic finish on all Esco laboratory equipment products.

World-Class Research and Development

At Esco, continuous research and development is a corporate policy realized through tangible investments in personnel, equipment and facilities. Currently, 1 out of every 2 non-production staff at Esco works in a research and development position.

Visitors are welcome to visit the Esco Biotech Equipment Technology Centre located in Singapore at our worldwide headquarters, which features a demonstration laboratory, conference / training facilities for visitors, and various testing laboratories in which state-of-the-art research and tests are continuously conducted into improving the performance of our products.



The laboratories are equipped with the latest instruments, properly calibrated and maintained: particle counters, air velocity meters, flow visualization devices, KI discus testing apparatus, electrical safety analysers, light / noise level / vibration meters and microbiological / containment test instruments.

ISO 9001 Quality Management System



At Esco, quality and customer satisfaction are our top priorities, which is why the company operates under an ISO 9001 certified quality management system. Extensive quality control and testing is carried out at all steps of the design and production process.

ISO 14001 Environmental Management System



Esco also practices responsible corporate citizenship by demonstrating a firm commitment to the environment. Many Esco products are designed for low energy consumption, while our cabinets are also constructed of easily recyclable stainless steel.

Commitment to the Global Marketplace

Esco regularly participates in numerous major international, regional and national industry trade shows and exhibitions, both directly and indirectly with the regional distributors. For the updates on Esco's upcoming events and exhibitions, visit our website section: <http://biotech.escoglobal.com/tradeshows.htm>





OTHER PRODUCTS AVAILABLE FROM ESCO BIOTECH:

**Vertical Laminar Flow Cabinets
Horizontal Laminar Flow Cabinets
PCR Vertical Laminar Flow Cabinets**

**Class II Biosafety Cabinets
Class III Biosafety Cabinets**

**Cytotoxic Cabinets
IVF Cabinets
Weighing Cabinets
Animal Handling Workstations**

Custom-Made Clean-Air / Containment Workstations

Your local distributor:

Esco Biotechnology Equipment Division

21 Changi South Street 1
Singapore 486777
tel: +65 6542 0833 fax: +65 6542 6920
email: biotech@escoglobal.com
website: biotech.escoglobal.com

