

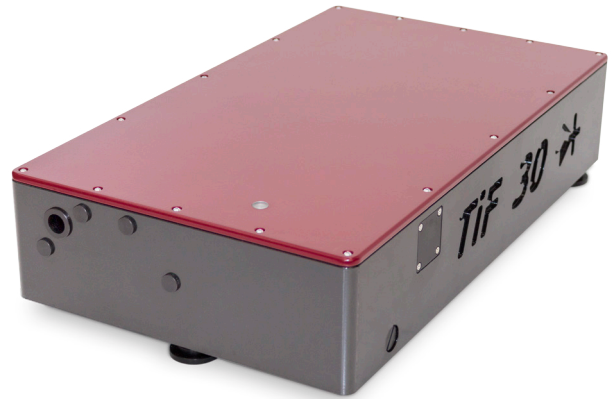

TiF-DP. Femtosecond Ti:Sapphire Laser with Direct Diode Pumping

- Integrated diode pump source with control unit
- Tuning range 760-840 nm
- Pulse duration <20 fs
- Output power up to 200 mW
- Thermally stabilized monolithic body
- Integrated spectrometer and power meter (optional)
- Fully remote laser output control (optional)
- Automatic mode-locking and power stability locking (optional)



The TiF-DP-30 femtosecond laser system with on-board pump source

Product overview

The novel TiF-DP system is a Ti:Sapphire femtosecond laser oscillator having its active medium directly pumped by emission from a laser diode assembly. Such architecture leads to significant cost reduction while system still maintains the output beam quality, pulse duration and long-term output power stability of conventional DPSS-laser-pumped systems. Average output power reaches 200 mW and is sufficient enough to use the TiF-DP series systems as a seed laser source for amplifier systems with enough headroom, as well as implement it in numerous scientific research applications. The laser design features a rigid monolithic thermally stabilized body and ensures long-term output power stability drift below 0.5% rms.

The laser system may be factory-optimized for any of the three main output pulse duration choices: 20, 30 or 50 fs (with 100 fs by special request). The general rule is that accessible values of output power and tuning range width increase with longer output pulse duration.

There are two pre-designed factory supply packages:

- the "Basic" factory package includes a simple USB motorized wavelength tuning slit and a push-button non-automatic electric starter. Wavelength tuning and calibration with this package is done via step number information in basic Windows software.

- the "Auto" factory package includes built-in spectrometer and power meter, single-touch wavelength tuning with presets, configurable widget software, active power lock function and automatic mode-lock start and monitoring. With this package the system boasts exceptional long-term stability and longer uninterrupted runtime.

An external prism pair or a tunable pulse compressor (the APC Kit or APC Pro units) for dispersion pre-compensation is also available.



Widget-based software screenshot for the TiF family of lasers with integrated spectrometer ("Auto" package)

Possible applications of the TiF Series lasers:

- Multiphoton microscopy
- Seed oscillator for amplifier systems
- Terahertz generation
- "Pump-probe" spectroscopy
- Material processing
- Optical coherent tomography
- Semiconductor Device Characterization
- Fundamental Research



AVESTA
LASERS AND OPTICAL SYSTEMS



Avesta Ltd., 11 Fizicheskaya Street
Troitsk, 108840, Moscow, Russia
Tel.: +7 (495) 967-94-73
Fax: +7 (495) 646-04-95

fs@avesta.ru
www.avesta.ru

	TiF-DP-20	TiF-DP-30	TiF-DP-50
Spectrally-limited pulse duration¹⁾	<20 fs ²⁾	<30 fs ²⁾	<50 fs (<100 fs upon request)
Spectrum width (FWHM)¹⁾	>50 nm	>30 nm	>18 nm
Tuning range	800±10 nm (fixed)	770-830 nm	760-840 nm
Average output power^{1),3)}	>120 mW	>150 mW	>170 mW

General optical specifications

Pulse repetition rate (fixed)	90±10 MHz
Pump source	integrated, direct diode pump
Spatial mode and M²	TEM ₀₀ (M ² <1.2)
Beam diameter (1/e²)	<2 mm
Output polarization	linear, horizontal, PER >20 dB
Beam divergence	<1 mrad
Long-term stability³⁾	<0.5% rms
Noise	<0.5% rms (10 Hz to 10 MHz bandwidth)

Physical dimensions (L × W × H)

Laser head dimensions	510 × 270 × 119 mm
Pump laser control unit dimensions	290 × 200 × 80 mm
Closed-loop chiller dimensions	430 × 340 × 190 mm

Environmental and utility specifications

Operating temperature	15-30°C
Relative humidity	<60%, non-condensing
Voltage	single-phase; 100-240 VAC; 50/60 Hz
Power consumption	<1 kW

Available configuration packages⁴⁾

"Basic" package (default)	<ul style="list-style-type: none"> - thermally stabilized body - SMA pulse train sync output - mode-lock status LED indication - push-button starter - USB 2.0 wavelength tuning via step-motor slit (via step number information and calibration) PC requirements: USB 2.0 port, Windows 10
"Auto" package	<ul style="list-style-type: none"> - thermally stabilized body - SMA pulse train sync output - mode-lock status LED indication - built-in spectrometer - single-touch wavelength tuning w. presets - built-in power meter - active output power stability locking - automatic mode-lock start and monitoring - Windows software with configurable widgets PC requirements: USB 2.0 port, Windows 10

1) - when tuned to 800 nm; pulse duration is measured by the AA-10DD-12PS (Avesta) interferometric autocorrelator;

2) - with an external dispersion compensator (not included; offered separately, see APC);

3) - after 30 min warm-up with cold start, during 12-hour continuous operation under equal room temperature conditions using recommended stabilized closed-loop chiller with proper capacity and active output power locking ("Auto" package);

4) - please select one of the packages for your system; certain features may be tailored or combined differently according to specific customer requirements.

China: Eachwave scientific instrument Co., Ltd
 Tel: +86-21-62209657, +86-21-54843093
 Email: sales@eachwave.com
 Web: www.eachwave.com

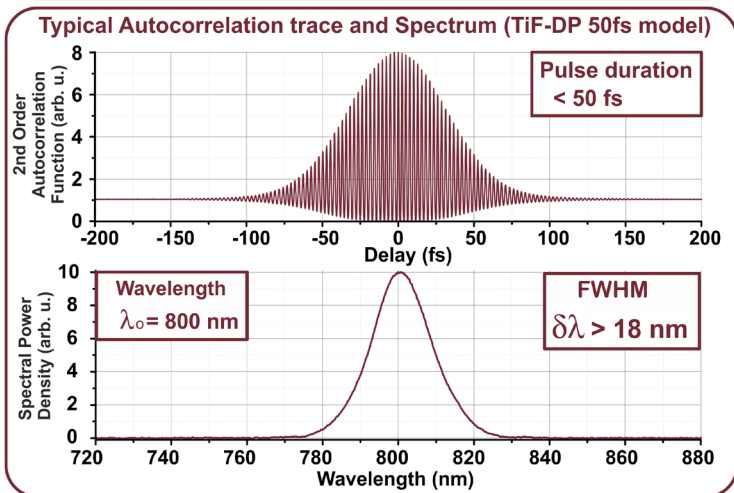
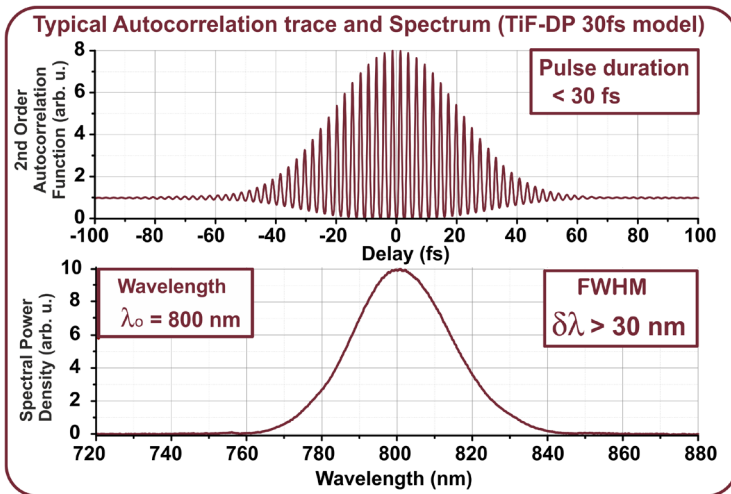
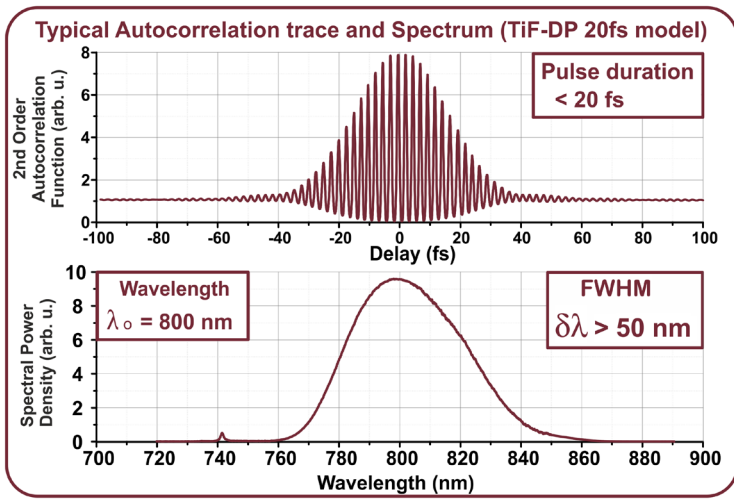

Three configurations of the TiF-DP series femtosecond Ti:S oscillator

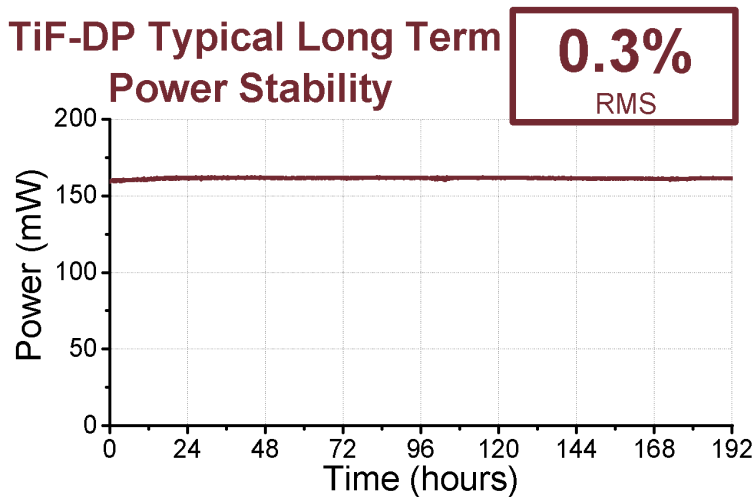

192 hours continuous stability run, acquired using an integrated pump module, at an ambient temperature of 22 degrees C, with "Auto" package and active power locking

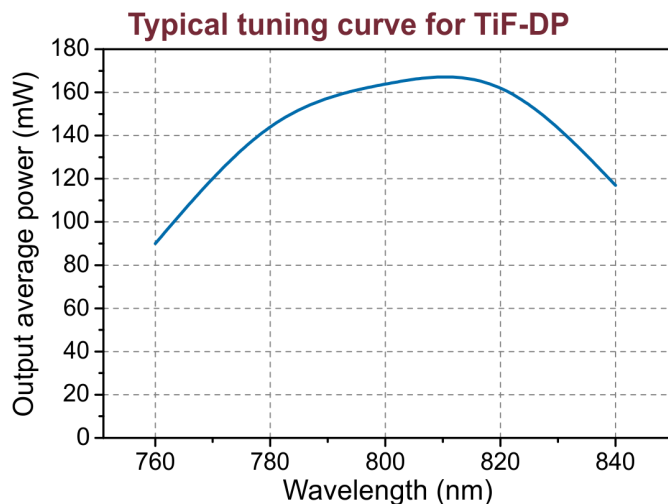

TiF-DP-50 wavelength tuning curve

China: Eachwave scientific instrument Co., Ltd
 Tel: +86-21-62209657, +86-21-54843093
 Email: sales@eachwave.com
 Web: www.eachwave.com

TiF DP optical head dimensions

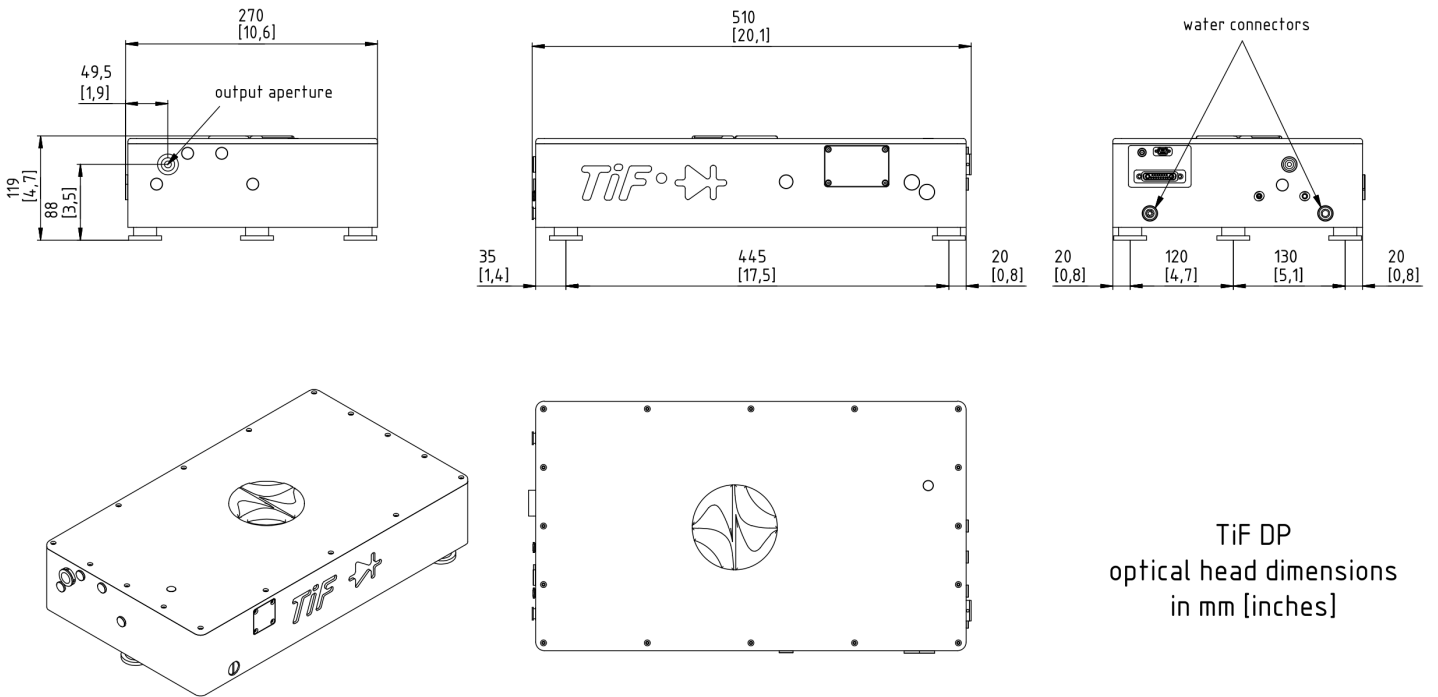

TiF DP
optical head dimensions
in mm [inches]

TiF-DP dimensions in mm [inch] with integrated diode pump

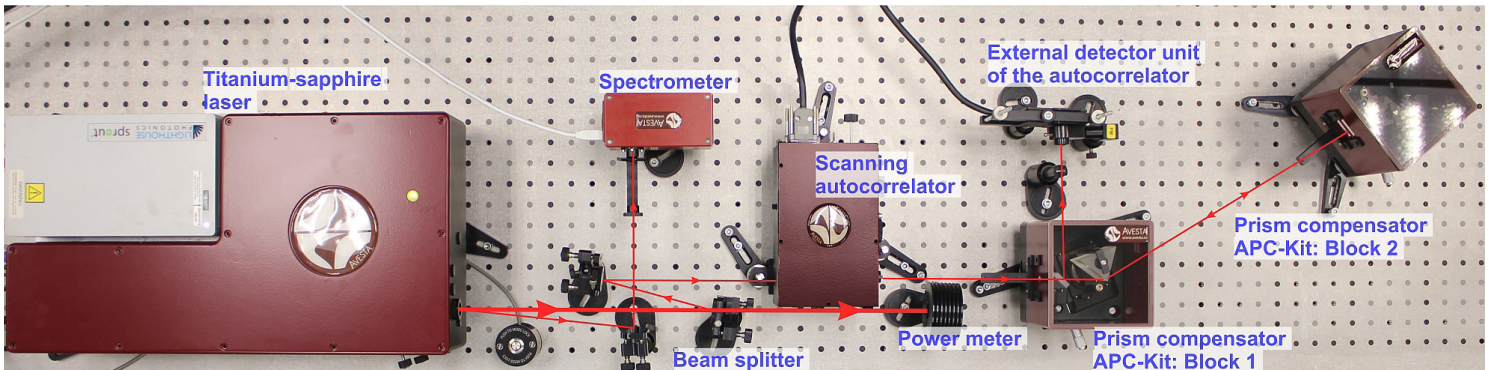

Possible total dispersion control setup for multi-photon microscopy applications with TiF Series laser, APC Kit dispersion compensator and AA-M scanning autocorrelator with an external detector unit

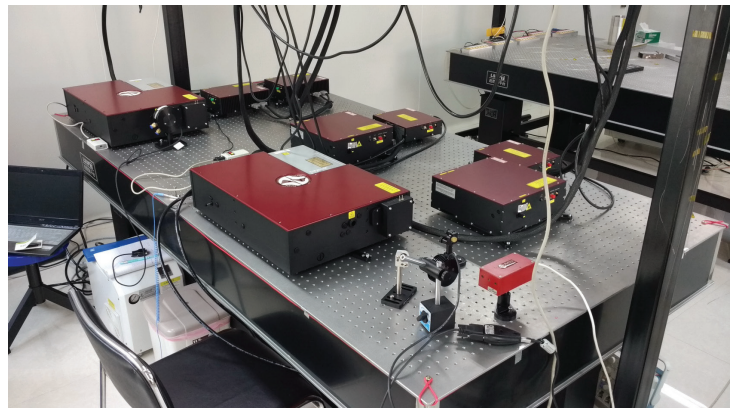

Installed TiF Series laser systems at customers' sites