

Lt Camera Series

Compact, Lightweight USB3 Cameras

Compact and light-weight USB 3 cameras that provide both monochrome and vivid color images for the most demanding environments.

Teledyne Lumenera's Lt Camera Series digital cameras are built for rugged 24/7 use. Based on the latest advanced Starvis™ and Pregius™ CMOS sensors from Sony® capturing excellent quality images. Using the fully locking USB 3.1 Gen 1 cabling, the Teledyne Lumenera Lt Camera Series offers a variety of high performance models for many applications.



Key Features

Wide selection of advanced Sony Global shutter and Rolling shutter CMOS sensors to meet the diverse requirements of today's industrial imaging applications.

Reliability

Robust enclosure and ease of integration with USB 3.1 Gen 1 plug-and-play interface and fanless body, small footprint and lower power requirements















Applications

Ready to meet the challenges of embedded system applications such as aerial imaging, intelligent traffic systems (ITS), robotic inspection, and life sciences.

Compatibility

Flexible, proven 32 and 64-bit operating system compatibility for, Windows, Linux, Linux for embedded system platforms, and single board computers (SBCs).







Lt CAMERA SERIES SPECIFICATIONS

	Active Resolution	Sensor Model	Frame Rate (Burst Mode)	Pixel Size	Dynamic Range	Max. Image Circle	Part Number**	Lens Mount Option
 Lt-C1610	1608 x 1104	Sony IMX432 (1.7M)	96 fps	9.00 µm	72.1 dB	1.1" Optical Format	LT-UC11-C1610IF	C-mount STD With IR cut-off filter
							LT-UC11-C1611IF	CS-mount STD With IR cut-off filter
 Lt-M1610	1608 x 1104	Sony IMX432 (1.7M)	96fps	9.00 µm	72.1 dB	1.1" Optical Format	LT-UM11-M1610	C-mount STD
							LT-UM11-M1611	CS-mount STD
 Lt-C1630	1632 x 1248	Sony IMX430 (2.0M)	86 fps	4.50 µm	73 dB	1/1.7" Optical Format	LT-UC11-C1630IF	C-mount STD With IR cut-off filter
							LT-UC11-C1631IF	CS-mount STD With IR cut-off filter
 Lt-M1630	1632 x 1248	Sony IMX430 (2.0M)	86 fps	4.50 µm	73 dB	1/1.7" Optical Format	LT-UM11-M1630	C-mount STD
							LT-UM11-M1631	CS-mount STD
 Lt-C1900	1944 x 1096	Sony IMX327 (2.1M) RS*	60 fps	2.90 µm	72.8 dB	1/2.8" Optical Format	LT-UC10-C1900IF	C-mount STD With IR cut-off filter
							LT-UC10-C1901IF	CS-mount STD With IR cut-off filter
 Lt-C1950	1936 x 1216	Sony IMX392 (2.3M)	162 fps	3.45 µm	73.27 dB	1/2.3" Optical Format	LT-UC10-C1950IF	C-mount STD With IR cut-off filter
							LT-UC10-C1951IF	CS-mount STD With IR cut-off filter
 Lt-M1950	1936 x 1216	Sony IMX392 (2.3M)	162 fps	3.45 µm	73.27 dB	1/2.3" Optical Format	LT-UM10-M1950	C-mount STD
							LT-UM10-M1951	CS-mount STD
 Lt-C2020	2064 x 1544	Sony IMX265 (3.2M)	55 fps	3.45 µm	73.56 dB	1/1.8" Optical Format	LT-UC11-C2020IF	C-mount STD With IR cut-off filter
							LT-UC11-C2021IF	CS-mount STD With IR cut-off filter
 Lt-M2020	2064 x 1544	Sony IMX265 (3.2M)	55 fps	3.45 µm	73.56 dB	1/1.8" Optical Format	LT-UM11-M2020	C-mount STD
							LT-UM11-M2021	CS-mount STD
 Lt-C2050	2064 x 1544	Sony IMX252 (3.2M)	151 fps	3.45 µm	73 dB	1/1.8" Optical Format	LT-UC00-C2050	C-mount STD
							LT-UC00-C2050IF	C-mount STD with IR cut-off filter
 Lt-M2050	2064 x 1544	Sony IMX252 (3.2M)	151 fps	3.45 µm	73 dB	1/1.8" Optical Format	LT-UM00-M2050	C-mount STD
							LT-UM00-M2050CG	C-mount STD with clear glass
 Lt-C2420	2464 x 2056	Sony IMX264 (5.1M)	35 fps	3.45 µm	73.2 dB	2/3" Optical Format	LT-UC11-C2420IF	C-mount STD With IR cut-off filter
							LT-UC11-C2421IF	CS-mount STD With IR cut-off filter
 Lt-M2420	2464 x 2056	Sony IMX264 (5.1M)	35 fps	3.45 µm	73.2 dB	2/3" Optical Format	LT-UM11-M2420	C-mount STD
							LT-UM11-M2421	CS-mount STD
 Lt-C2450	2464 x 2056	Sony IMX250 (5.1M)	93 fps	3.45 µm	73 dB	2/3" Optical Format	LT-UC00-C2450	C-mount STD
							LT-UC00-C2450IF	C-mount STD with IR cut-off filter
 Lt-M2450	2464 x 2056	Sony IMX250 (5.1M)	93 fps	3.45 µm	73 dB	2/3" Optical Format	LT-UM00-M2450	C-mount STD
							LT-UM00-M2450CG	C-mount STD with clear glass
 Lt-C3200	3216 x 2208	Sony IMX428 (7.1M)	50 fps	4.50 µm	73 dB	1.1" Optical Format	LT-UC11-C3200IF	C-mount STD with IR cut-off filter
							LT-UC11-C3201IF	CS-mount STD with IR cut-off filter
 Lt-M3200	3216 x 2208	Sony IMX428 (7.1M)	50 fps	4.50 µm	73 dB	1.1" Optical Format	LT-UM11-M3200	C-mount STD
							LT-UM11-M3201	C-mount STD with clear glass
 Lt-C3840	3840 x 2160	Sony IMX334 (8.3M) RS*	44 fps	2.00 µm	70.53 dB	1/1.8" Optical Format	LT-UC10-C3840IF	C-mount STD With IR cut-off filter
							LT-UC10-C3841IF	CS-mount STD With IR cut-off filter
 Lt-M3840	3840 x 2160	Sony IMX334 (8.3M) RS*	44 fps	2.00 µm	70.53 dB	1/1.8" Optical Format	LT-UM10-M3840	C-mount STD
							LT-UM10-M3841	CS-mount STD
 Lt-C4030	4112 x 2176	Sony IMX267 (8.9M)	31 fps	3.45 µm	73.27 dB	1" Optical Format	LT-UC11-C4030IF	C-mount STD With IR cut-off filter
 Lt-M4030	4112 x 2176	Sony IMX267 (8.9M)	31 fps	3.45 µm	73.27 dB	1" Optical Format	LT-UM11-M4030	C-mount STD
 Lt-C4060	4112 x 2176	Sony IMX255 (8.9M)	56 fps	3.45 µm	72.7 dB	1" Optical Format	LT-UC00-C4060	C-mount STD
							LT-UC00-C4060IF	C-mount STD with IR cut-off filter
 Lt-M4060	4112 x 2176	Sony IMX255 (8.9M)	56 fps	3.45 µm	72.7 dB	1" Optical Format	LT-UM00-M4060	C-mount STD
							LT-UM00-M4060CG	C-mount STD with clear glass

* Rolling Shutter sensors

** For LuCam software compatible part number, please use pn: LT-~~L~~xxx-xxxxxxx

Lt CAMERA SERIES SPECIFICATIONS

	Active Resolution	Sensor Model	Frame Rate Burst Mode	Pixel Size	Dynamic Range	Max. Image Circle	Part Number**	Lens Mount Option
 Lt-C4020	4112 x 3008	Sony IMX304 (12M)	22 fps	3.45 µm	73.22 dB	1.1" Optical Format	LT-UC11-C4020IF	C-mount STD With IR cut-off filter
 Lt-M4020	4112 x 3008	Sony IMX304 (12M)	22 fps	3.45 µm	73.22 dB	1.1" Optical Format	LT-UM11-M4020	C-mount STD
 Lt-C4040	4112 x 3008	Sony IMX253 (12M)	40 fps	3.45 µm	74 dB	1.1" Optical Format	LT-UC00-C4040	C-mount STD
							LT-UC00-C4040IF	C-mount STD with IR cut-off filter
 Lt-M4040	4112 x 3008	Sony IMX253 (12M)	40 fps	3.45 µm	74 dB	1.1" Optical Format	LT-UM00-M4040	C-mount STD
							LT-UM00-M4040CG	C-mount STD with clear glass
 Lt-C5500	5472 x 3648	Sony IMX183 (20M) RS*	19.6 fps	2.4 µm	73 dB	1" Optical Format	LT-UC10-C5500IF	C-mount STD with IR cut-off filter
 Lt-M5500	5472 x 3648	Sony IMX183 (20M) RS*	19.6 fps	2.4 µm	73 dB	1" Optical Format	LT-UM10-M5500	C-mount STD

* Rolling Shutter sensors

** For LuCam software compatible part number, please use pn: LT-Lxxx-xxxxxxx

Lt CAMERA SERIES FAMILY SPECIFICATIONS (COMMON TO ALL MODELS)

	Lt Camera Series (Standard)	Lt Camera Series (with P-IRIS)
Data Output Transfer	USB3.1 (5 Gbit/s)	
Exposure Control	Manual and automatic control	
I/O Ports	Locking connector; includes trigger in, strobe out, and auxiliary power input	
Image Buffers	128 MB	
Lens Mount	Standard CS & C mount available	Standard C Mount
Size (L x H x W)	36.1 mm x 45 mm x 45 mm	61 x 44 x 44 mm (2.4 x 1.73 x 1.73 inches)
Mass	88 g	140 g
Operating Temp	0 to 50 °C	
Power Supply	5V via Power Over USB	5V via Power Over USB, 1.5 A, power through auxiliary I/O connector
Power Dissipation	2.3 W to 3.6 W	~4 W
Data Connector	USB3 Type micro-B (Locking Connector supported)	
Power and I/O Connector	JST# SM09B-NSHSS-TB (mating part :JST # NSHR-09V-S)	Hirose-8 male connector. P-iris 4 pin connector
Camera Specification	USB 3.1 interface , USB3 Vision v1.0 compliant	
Software Platform	Teledyne Sopera LT 8.6 for Windows, Lumenera Camera Software Development Kit (LINUX) or 3rd Party GenICam compliant SDK	

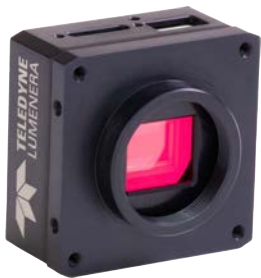

RESPONSIVITY GRAPHS

Lt-C1900

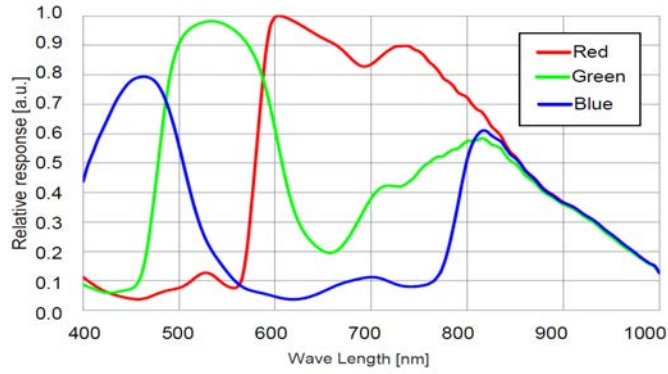

Lt-C3840

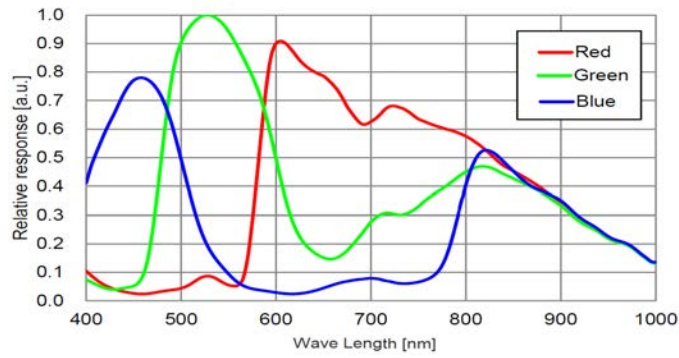

Lt-M3840

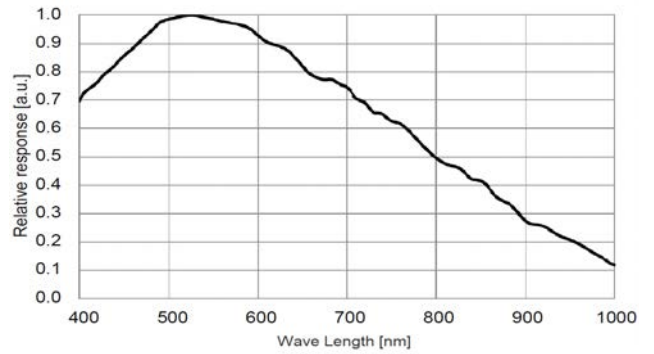

Lt-C1950, C2020, C2050, C2420, C2450, C4030, C4060, C4020, C4040

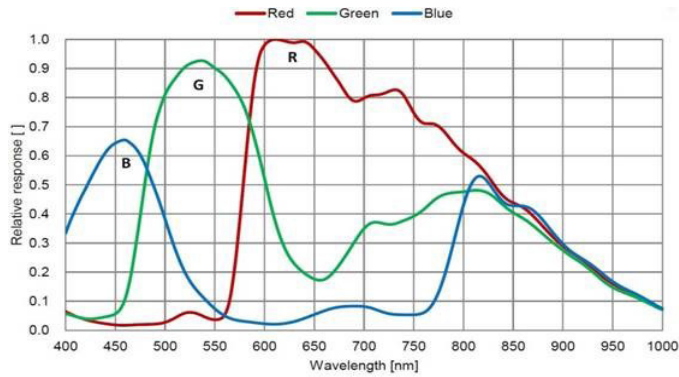

Lt-M1950, M2020, M2050, M2420, M2450, M4030, M4060, M4020, M4040

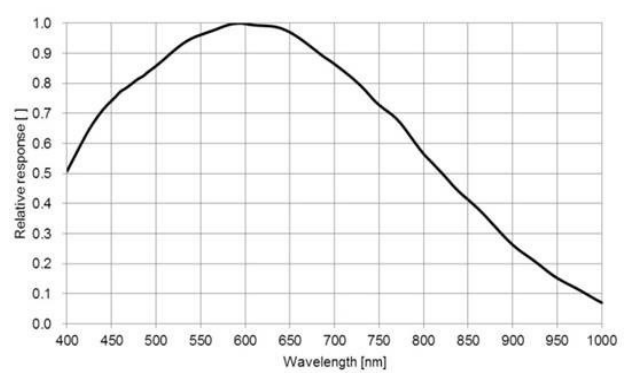

RESPONSIVITY GRAPHS

Lt-C1610, C1630, C3200

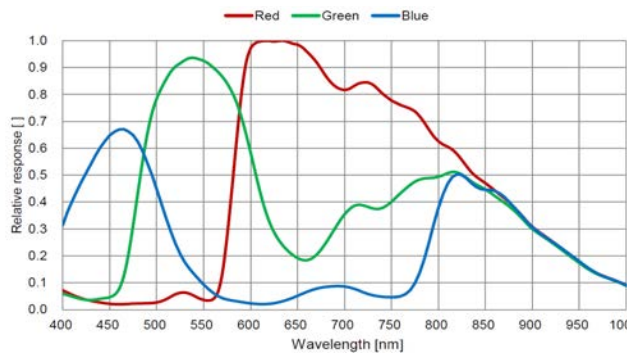

Lt-M1610, M1630, M3200

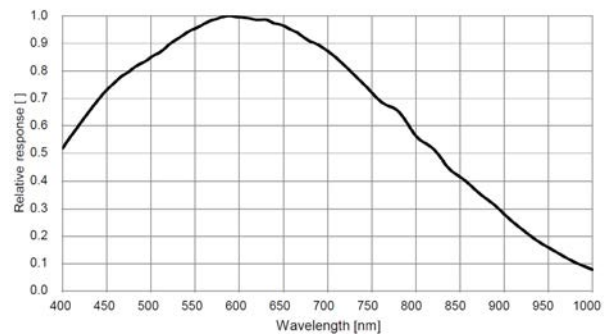

Lt-C5500

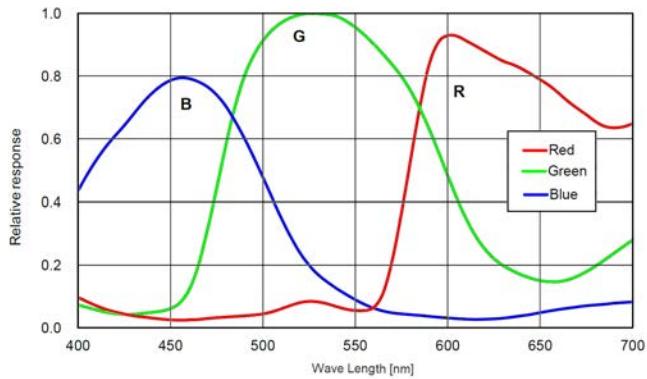

Lt-M5500

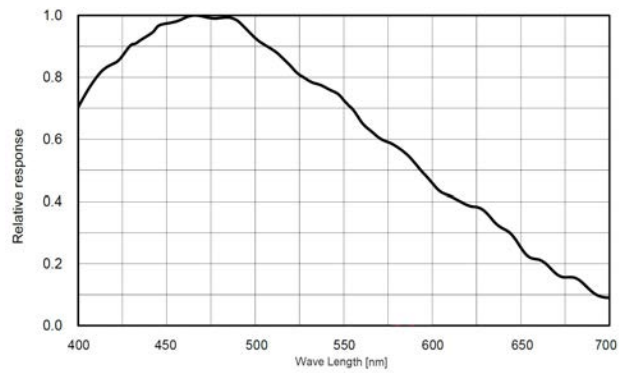

Lt Camera Series Specifications

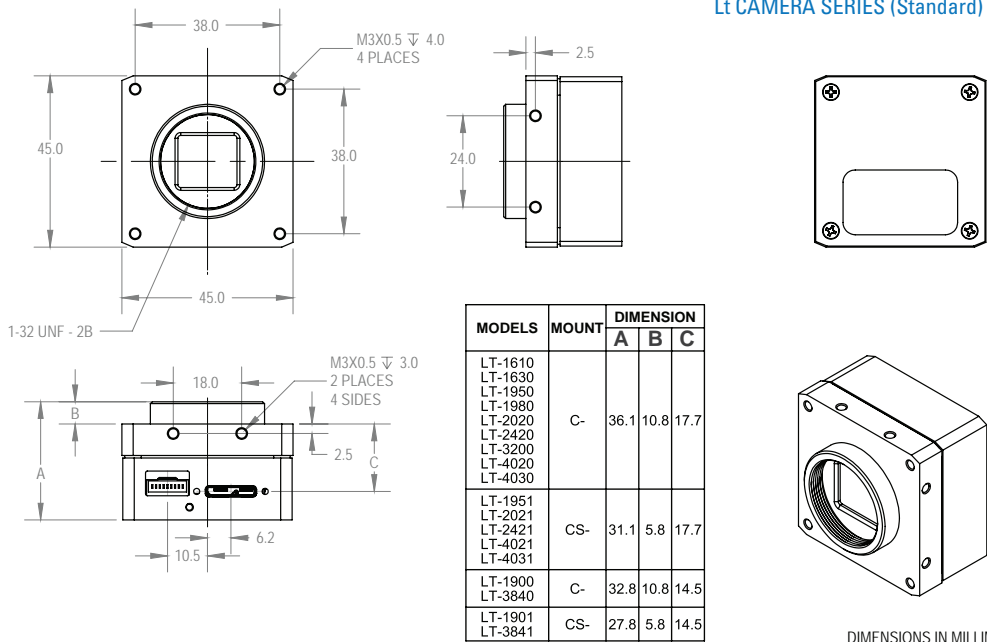
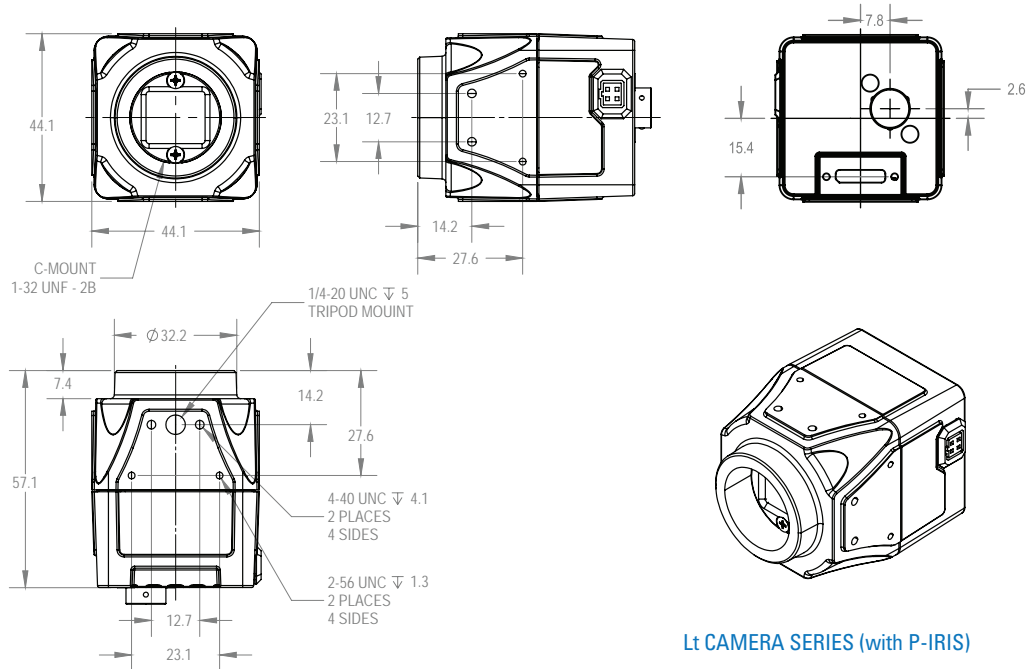

www.teledynelumenera.com

North America
Ottawa, Canada
7 Capella Court,
(TEL) +1 613-736-4077

© 2021 Teledyne Lumenera Corporation. All rights reserved.
Design, features, and specifications are subject to change without notice. 02102021



Versatile cameras featuring Sony Pregius & Starvis sensors

www.teledynelumenera.com

North America

Ottawa, Canada
7 Capella Court,
(TEL) +1 613-736-4077

© 2021 Teledyne Lumenera Corporation. All rights reserved.
Design, features, and specifications are subject to change without notice. 02102021