

# 1000

## PlasmaPro<sup>®</sup> 100 Estrelas

Deep Silicon Etch System



*The Business of Science<sup>®</sup>*



# 100

## PlasmaPro 100 Estrelas

### Silicon etch solutions for multiple applications

The **PlasmaPro 100** Estrelas platform is designed to give total flexibility for Deep Silicon Etch (DSiE) applications - serving a diverse set of process requirements across the Micro Electro Mechanical Systems (MEMS), Advanced Packaging and Nanotechnology markets.

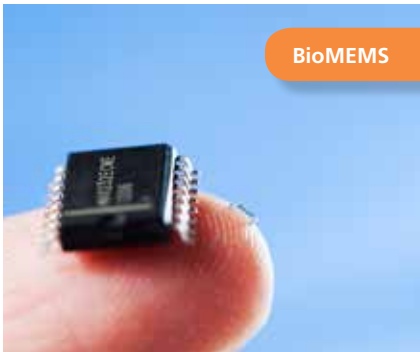

MEMS Inertial Sensors

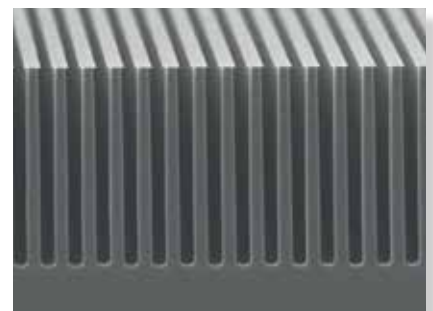

Smooth sidewall cryogenic DSE (no scallops)  
Courtesy TU Twente

### Emerging applications

Oxford Instruments Plasma Technology continues to provide technologies that address existing and emerging applications in the MEMS, Advanced Packaging and Nanotechnology markets. With a broad process and application portfolio, our technologies enable many of the applications identified today and those of tomorrow. The development of the **PlasmaPro 100** Estrelas deep silicon etch technology from Oxford Instruments delivers industry leading process performance.





## Supporting R&D and Production

Developed with both the research and production markets in mind, the **PlasmaPro 100** Estrelas offers the ultimate in process flexibility. Nano and micro-structures may be realised as the hardware has been designed with the ability to support high performance Bosch™ and cryo DSIe technologies in the same chamber.

From smooth sidewall processes to high etch cavity etches and high aspect ratio processes to tapered via etches, the **PlasmaPro 100** Estrelas has been designed to ensure that the wide range of applications in MEMS, advanced packaging and nanotechnology can be realised without the need to change chamber hardware.

The **PlasmaPro 100** Estrelas may be configured with higher specification hardware options to support the future needs of advanced R&D and production users. These include an electrostatic chuck (also capable of clamping non-conductive substrates without back metallisation), higher capacity pumping and higher power generators. Clustering options for multiple chambers with vacuum cassette interface are available to meet high throughput requirements.

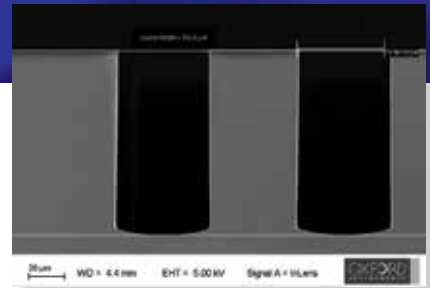

100µm feature etched at >21µm/min

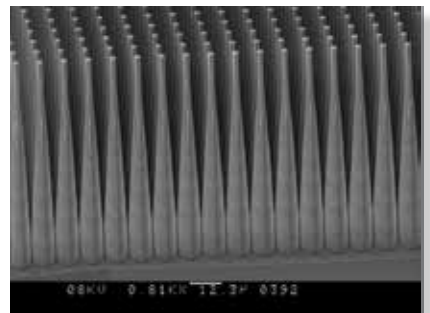

Cryogenic Si Etch. Courtesy TU Twente

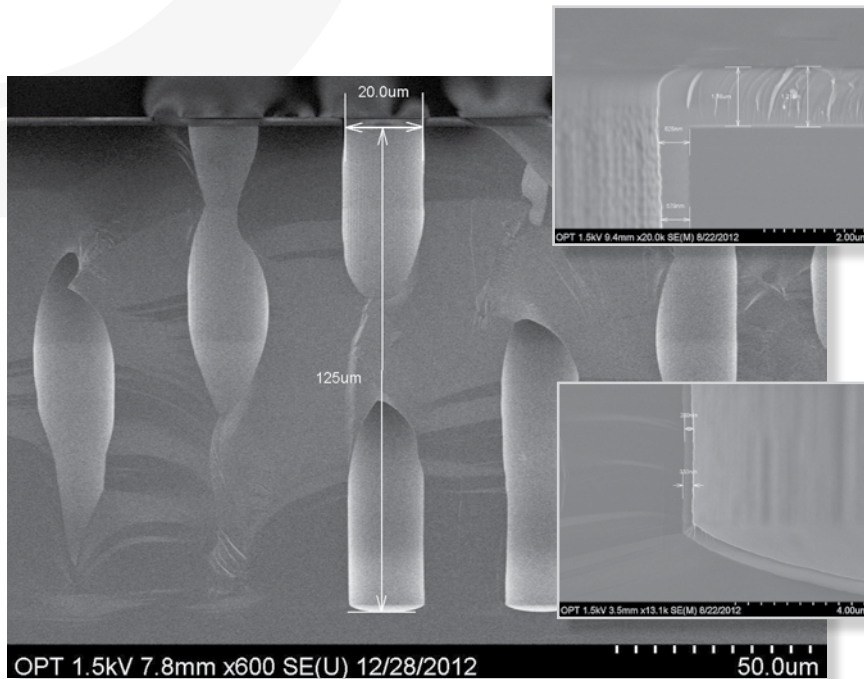

20µm via to 125 depth with TEOS liner

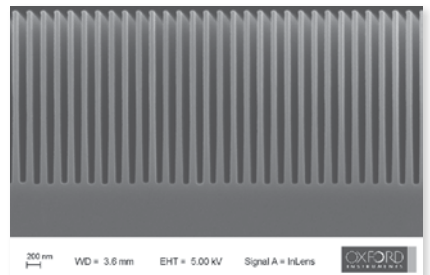

110nm wide trench, smooth sidewall 2.5µm depth (23:1 AR)

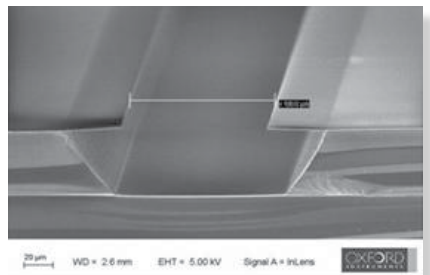

>15µm/min tapered etch with 63±2° profile angle

# PlasmaPro 100 Estrelas

Exceptional flexibility and throughput

## Superior technical capabilities

Compatible with 50mm to 200mm substrates, ensuring that you have the ability to develop devices that can be taken to production using the same chamber hardware.

- Mechanical or electrostatic clamping
- Heated liners
  - Improved reproducibility
  - Increased mean time between cleans (MTBC)
- Fast-acting close coupled MFCs with fast control (originally developed for ALD)
- Reduced chamber volume and high throughput pumping ensuring high gas conductance
- Higher flow MFCs and associated generators for high radical densities
- Auto match for process flexibility
- Sub-second Bosch switching times (patent pending)
- Low Cost of Ownership through optimised hardware and process control
- Low exposed area (<1%) end point capability



Plasma  
etch tool  
Specifically  
designed for  
silicon etch





## Single Wafer Loadlock

The **PlasmaPro 100** Estrelas System loadlock has been ergonomically designed to allow quick and easy access for sample transfer.

## Cluster platform

For the ultimate in throughput and productivity, the **PlasmaPro 100** Estrelas etch is also available with low cost research or Brooks industry-leading transport modules

- Square or hexagonal standard chamber configurations
- 1 or 2 cassette load locks
- Through wall or ballroom options



## Reliability and diagnostics

Fault and tool status diagnostics are achieved through the front end software. The system reports on the status of key components, leading to rapid and detailed fault identification.



# 1000

## PlasmaPro 100 Estrelas

### System control and global process support

#### System control

- Clear and simple to use software ensures ease of use for process operators, while retaining the full functionality for production facility managers and service staff.
- Fully SECS/GEM compatible
- The front end visual interface, which controls and monitors the process tool, is configured exactly for the customer's system
- Process recipes are written, stored and recalled through the same software, allowing a comprehensive recipe library to be built
- Password controlled user login allows different levels of user access and tasks, from 'one -button' run operation to full system control
- Continuous system data logging (50 ms) ensures effective traceability of each wafer and process run



Low cost of ownership and world class customer support

#### Global process support for the lifetime of the tool

The priorities of Oxford Instruments' applications teams are:

- Fast turnaround of pre-sale development samples
- Effective post-sales support for the lifetime of the tool

To achieve this, we have dedicated applications laboratories in the UK, USA and Taiwan. With over 25 plasma systems in our labs, our engineers have the tools available to constantly be working on process and hardware developments.



## PlasmaPro 100 Estrelas

### Cost of ownership and global customer support

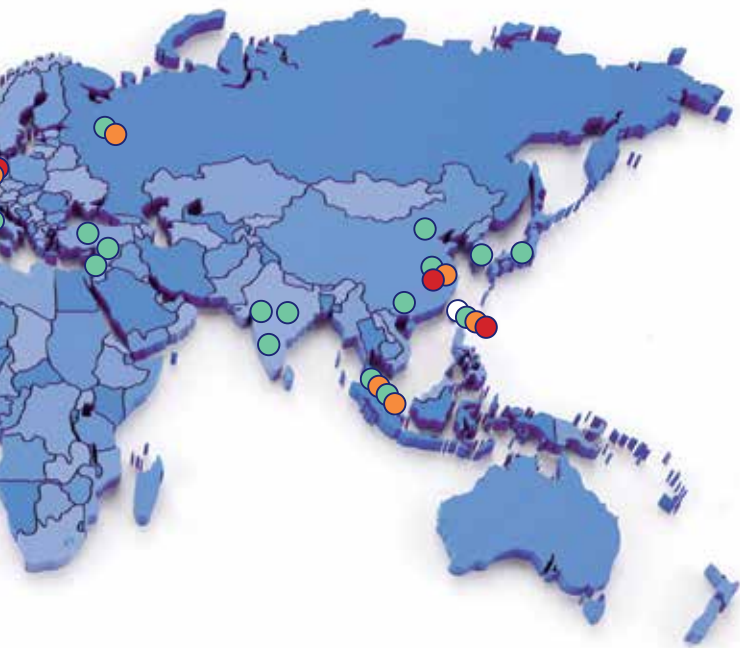

#### Cost of ownership and customer support

We work with you to create the right system, process, and support package to meet your specific requirements. Our range of Flexible Support Agreements will be tailored to your needs.

This can include:

- Guaranteed response times for support engineer visits and technical hotline calls
- Choice of support coverage up to 24/7
- Scheduled preventative maintenance calls
- Managed spares inventory options, including customer dedicated stock, via our parts locations worldwide
- Preferential spare part pricing
- Process training
- Certified training courses for your own engineers in preventative maintenance and first level troubleshooting

#### Superior environmental efficiency

**PlasmaPro 100** Estrelas has a low heat load and high energy efficiency.

The tool has efficient ergonomics and complies with Semi S2/S8 and cluster capability, making this a tool of choice.



# PlasmaPro 100 Estrelas

## Technical specifications

### Load lock configuration

All dimensions in mm.

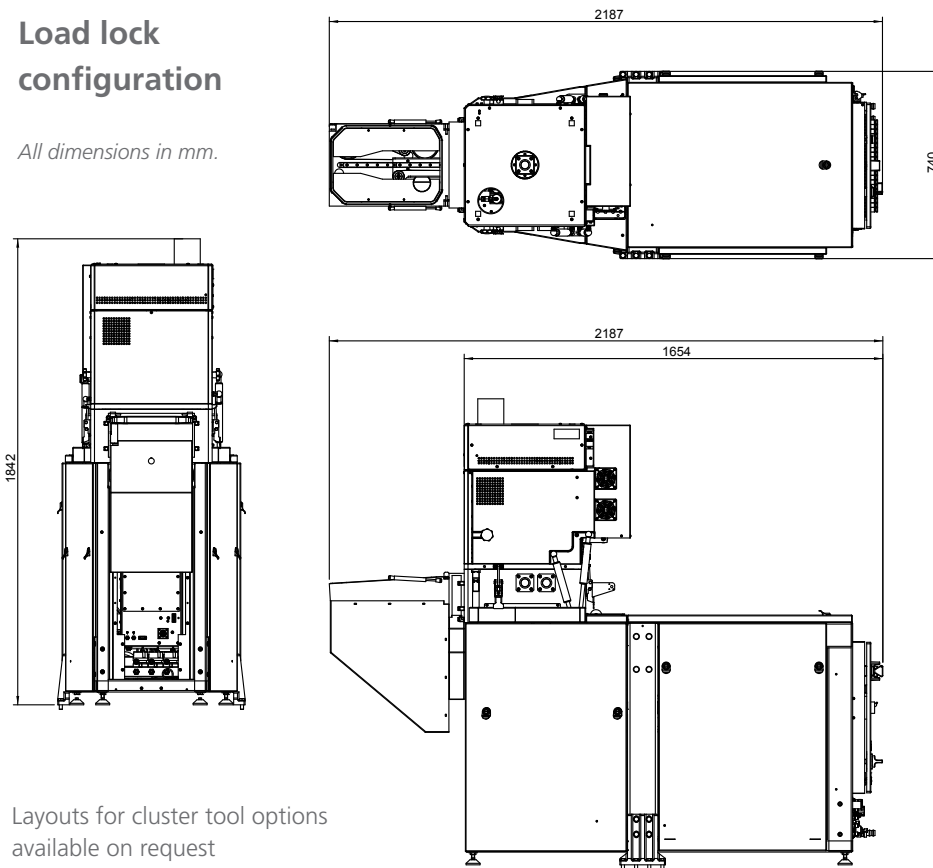

Layouts for cluster tool options available on request

### Oxford Instruments Plasma Technology

For more information please email:  
[plasma@oxinst.com](mailto:plasma@oxinst.com)

#### UK

Yatton  
Tel: +44 (0) 1934 837000

#### Germany

Wiesbaden  
Tel: +49 (0) 6122 937 161

#### India

Mumbai  
Tel: +91 22 4253 5100

#### Japan

Tokyo  
Tel: +81 3 5245 3261

#### PR China

Beijing  
Tel: +86 10 6518 8160/1/2

#### Shanghai

Tel: +86 21 6132 9688

#### Singapore

Tel: +65 6337 6848

#### Taiwan

Tel: +886 3 5788696

#### US, Canada & Latin America

Concord, MA  
TOLLFREE: +1 800 447 4717

[www.oxford-instruments.com](http://www.oxford-instruments.com)

visit [www.oxford-instruments.com](http://www.oxford-instruments.com) for more information

This publication is the copyright of Oxford Instruments Nanotechnology Tools Ltd and provides outline information only, which (unless agreed by the company in writing) may not be used, applied or reproduced for any purpose or form part of any order or contract or regarded as the representation relating to the products or services concerned. Oxford Instruments' policy is one of continued improvement. The company reserves the right to alter without notice the specification, design or conditions of supply of any product or service. Oxford Instruments acknowledges all trademarks and registrations. © Oxford Instruments Nanotechnology Tools Ltd, 2014. All rights reserved. Ref: OIPT/Estrelas100/2014/001



The Business of Science®