

Zyla_{sCMOS}

Dynamically Image Cells with
Breakthrough Precision and Clarity

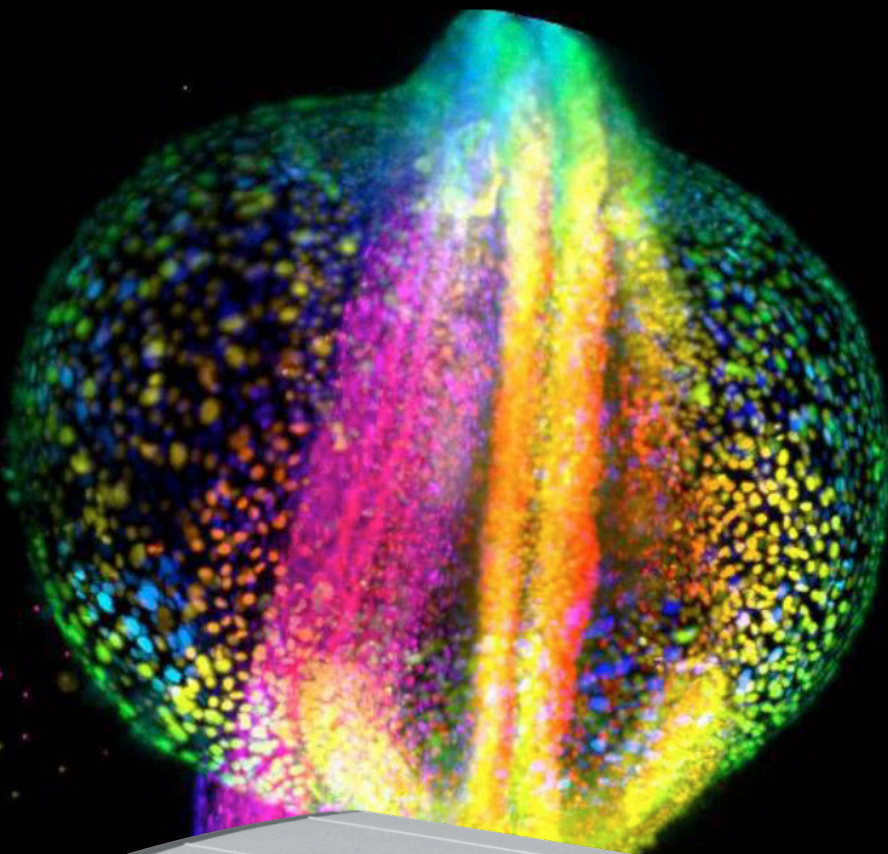

ZYLA 4.2 PLUS

- 4.2 megapixel sCMOS
- 82% QE, optimized for all fluorophores
- 0.9 e⁻ read noise
- 100 fps (53 fps USB 3.0)
- 33,000:1 dynamic range

ZYLA 5.5

- 5.5 megapixel sCMOS
- Rolling & True Global Shutter
- 0.9 e⁻ read noise
- 100 fps (40 fps USB 3.0)
- 33,000:1 dynamic range

- ✓ QE Boosted to 82%
- ✓ Industry fastest USB 3.0 speeds
- ✓ >99.8 % Quantitative Linearity

KEY INNOVATIONS OF THE NEW ZYLA 4.2 PLUS

1 QE Boosted to 82%

The latest-generation sCMOS sensor delivers a further 10% boost in QE, providing excellent broad coverage of the VIS/NIR region.

- ✓ Optimized for a broad range of fluorophores
- ✓ Reduced exposure times & faster frame rates
- ✓ Reduced phototoxicity / photobleaching
- ✓ Lower fluorophore concentrations – more accurate physiology

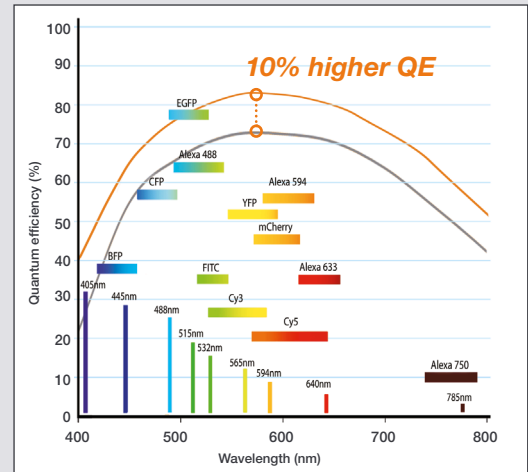

[Click here](#) to find out more about the Zyla 4.2 PLUS.

4 Application Modes

- LightScan PLUS** – Adapts the Rolling Shutter scan mode to applications such as Scanning LightSheet Microscopy and Line Scan Confocal
- FCS Mode** – Achieve up to 26,041 fps, ideal for Fluorescence Correlation Spectroscopy

2 Market Leading Speed

Superior data transfer efficiency and Zyla's 12-bit high speed mode combine to deliver an incredible 53 fps through super-convenient USB 3.0, coupled with market leading ROI frame rates.

With this capability, speed is on tap to allow you to follow faster dynamic processes with improved temporal resolution. Opt for the Camera Link version to access up to a blistering 100 fps (full resolution).

- ✓ Unique ROI processing capability – Faster ROI speeds
- ✓ 12-bit mode for fastest rates
- ✓ Follow faster temporal processes with a super-convenient USB 3.0 camera

Mode	Competing sCMOS USB 3.0	Zyla 4.2 PLUS USB 3.0
12-bit/ Full resolution	Not available	53 fps
16-bit/ Full resolution	40 fps	40 fps
12-bit/ 1024 x 1024	Not available	200 fps
16-bit/ 1024 x 1024	80 fps	160 fps

3 Market Leading Quantitative Linearity

Zyla 4.2 PLUS uses enhanced on-head intelligence to deliver market-leading linearity of > 99.8%, for unparalleled quantitative accuracy of measurement across the full dynamic range.

- ✓ Better than 99.8% linearity (>99.9% for low light range)
- ✓ Increased quantitative accuracy

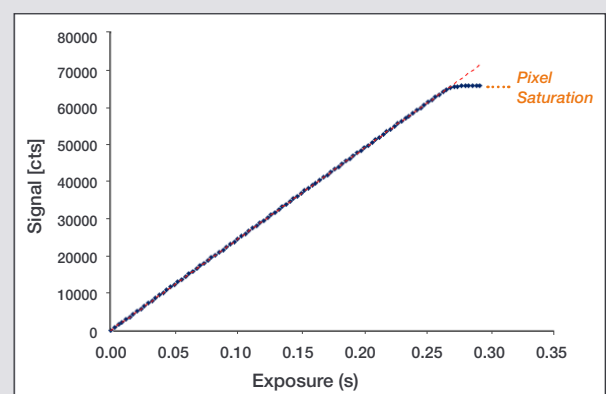

FEATURES & BENEFITS



Andor's Zyla sCMOS camera platform offers high speed, high sensitivity and high resolution imaging performance. The remarkably light and compact, thermoelectrically-cooled design, integrates perfectly into both laboratory and OEM applications alike. Zyla is ideally suited to many cutting edge experiments that push the boundaries of speed and sensitivity.

The unprecedented value and flexibility of the Zyla means it is also re-defining the concept of a 'workhorse' camera, rapidly displacing interline CCDs as the gold standard microscope detector.

Feature	Benefit
NEW QE _{max} boosted to 82%	Highest available photon capture efficiency across visible/NIR, optimized for all common fluorophores. Shorter exposures, reduced phototoxicity, lower dye concentrations for more accurate physiology.
~ 1 e ⁻ Read Noise	Noise floor down to 0.9e ⁻ . Lower detection limit than any CCD
NEW Market leading USB 3.0 speed	Superb USB 3.0 data transfer efficiency and Zyla's unique 12-bit high speed mode deliver up to 53 fps full resolution, 77% faster than competing sCMOS. Follow dynamic processes with improved temporal resolution.
100 fps (Camera Link)	Zyla offers '10-tap' Camera Link for maximum sustained frame rates. (Burst to 4GB on-head memory on Neo).
5.5 & 4.2 megapixel sensor formats and 6.5 μm pixels	Extremely sharp resolution over a 22 mm (Zyla 5.5) and 19 mm (Zyla 4.2 PLUS) diagonal field of view. Ideal for cell microscopy, astronomy and area scanning applications.
Rolling and Global shutter (Zyla 5.5)	Maximum exposure and readout flexibility across all applications. Global Shutter for 'interline CCD mode' freeze frame capture of fast moving/changing events.
Extended Dynamic Range	Unique 'dual gain amplifier' sensor architecture offering dynamic range of 33,000:1.
12-bit and 16-bit modes	12-bit Mode for smaller file size and absolute fastest frame rates through USB 3.0; 16-bit mode for full dynamic range
NEW Better than 99.8% linearity	Unparalleled quantitative measurement accuracy across the full dynamic range (> 99.9% for low light range).
Very Low Fan Vibration	Implemented on both models. Designed with vibration sensitive experiments in mind, such as super-resolution microscopy
LightScan PLUS	Maximise fluorescence signal and confocality concurrently in applications such as Scanned Light Sheet Microscopy and Line Scanning Confocal Microscopy
NEW FCS Mode	Fluorescence Correlation Spectroscopy requires the fastest possible speed from a minimal height ROI. Zyla 4.2 PLUS outputs a sustained 26,041 fps from a 2048(h) x 8(v) ROI.
Dark Noise Suppression (DNS) technology	Extremely competitive low darkcurrent of 0.1 e/pix/sec with fan cooling. Maintains low noise advantage across range of exposure conditions.
TE cooling to 0° C in up to 30 °C ambient	Ideal for OEM integration into enclosed systems.
Compact and Light	Ideal for integration into space restrictive set-ups. Ideal for OEM.
NEW GPU Express	Simplify and optimize data transfers from camera to Graphical Processing Unit (GPU) card to facilitate accelerated GPU processing as part of the acquisition pipeline.
Dynamic Baseline Clamp	Ensure quantitative stability
Hardware Timestamp	FPGA generated timestamp with 25ns accuracy.

Zyla 5.5

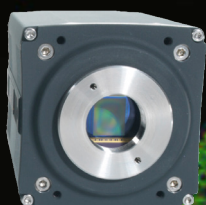

Zyla 5.5 is truly unique in offering **both Rolling and true Global shutter** capability in one sensor. Global shutter offers 'snapshot' imaging capability, whereby all pixels in the area are exposed simultaneously, and is directly analogous to that which is available in interline CCDs. True Global shutter is only available through the '5T' (5-transistor) sensor design exploited in the Zyla 5.5 offering greater application flexibility and is ideal for tight synchronization with microscope peripheral devices such as z-stage or switchable light source.

Please see **page 6** for a further comparison of Rolling shutter and Global shutter modes.

Zyla

THE BIOLOGIST'S CHOICE

Zyla sCMOS has proven a superb camera choice for the biologist and microscopist. Many simply see the Zyla as an **amazing value**, superb price/performance 'workhorse' camera with which to replace their existing interline CCD and **upgrade** the performance of their fluorescence microscope. Others are driven by distinct **application performance criteria** that only sCMOS can answer.

Quality, Throughput, Performance, Accessibility...

- ✓ **High Sensitivity & Wide Dynamic Range** – quantify very weak and very bright structures with one image.
- ✓ **Superb Image Quality** – high resolution and uniform backgrounds for publication quality imaging.
- ✓ **Capture Everything** – the larger field of view matches that of modern microscopes. Achieve better statistics and higher throughput in high content experiments.
- ✓ **Blazingly Fast** – more and more studies of cell processes require greater temporal resolution.
- ✓ **GPU Express** – for real time processing.
- ✓ **Ease of use** – designed to get you up and imaging with minimal fuss.
- ✓ **Flexible** – fast or slow, big or small, weak or bright... Zyla is adaptable for all of your imaging challenges.

Application Examples for the Zyla sCMOS

Physiology / Ion Imaging

The fast frame rate and excellent sensitivity of Zyla is ideally suited to the particular needs of ion signalling microscopy. Zyla 4.2 PLUS offers superlative sensitivity at speed, but electrophysiology may require the Global Shutter exposure mode of Zyla 5.5 to ensure temporal correlation across the whole image.

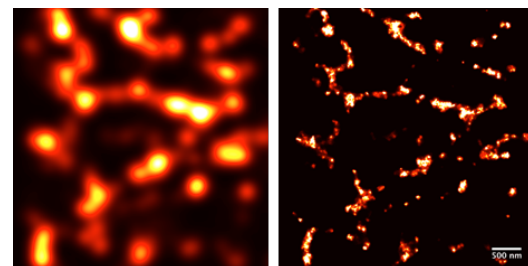

Images courtesy of Christian Soeller and Isuru Jayasinghe, Biomedical Physics, University of Exeter. Ryanodine receptor clusters in a mouse cardiac myocyte.

Super Resolution Microscopy

The low vibration, high QE, low noise and speed capability of Zyla 4.2 PLUS (USB 3.0 and Camera Link) is well suited to the particular detection criteria of single molecule based 'STORM / PALM' approaches, and is used by some as an alternative to EMCCDs for this purpose. Note, this should be considered distinct from the general needs of single molecule microscopy, which are best served by back-illuminated EMCCD cameras (see Andor iXon EMCCD range). Capability to switch off interpolative filtering and provision of custom blemish maps. **GPU Express** for real time data processing.

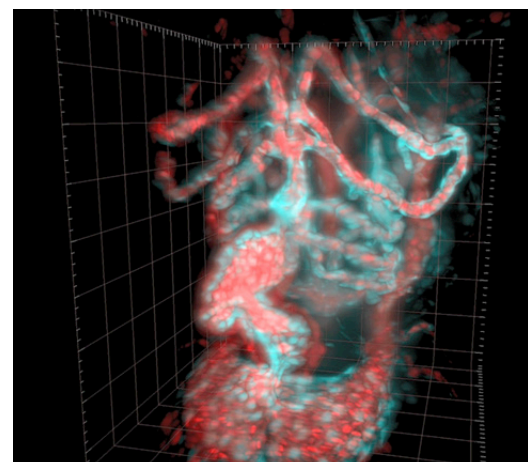

Image courtesy of Michael Weber, Max Planck Institute of Molecular Cell Biology and Genetics, Dresden. The image is an extract from a time series of a three day old Zebrafish beating heart. Blood cells are labelled red and heart muscle cells and vasculature labelled in cyan.

Light Sheet Microscopy

Andor sCMOS cameras have been at the forefront of innovative Light Sheet Microscopy development and significantly the Zyla 4.2 PLUS is now equipped with **LightScan PLUS**.

LightScan PLUS, ensures the user has additional control and flexibility over the functionality of the rolling shutter scan mode. LightScan PLUS allows the user to scan their scanning light source from the top to the bottom of the sensor, or vice versa, in one continuous sweep. In addition to this, and in direct response to user request, FlexiScan permits the independent adjustment of scan row height ('slit height') and line scan speed, allowing signal strength and confocality to be optimized concurrently. **CycleMax**, ensures the fastest frame rates can be achieved with no dead time and no need to reset the laser for each alternate frame. **GPU Express** for real time data processing.

Zyla

THE BIOLOGIST'S CHOICE

High Content Screening

Zyla sCMOS yields markedly improved throughput and statistical validity of data in high content analysis. For example, a larger field of view results in analysis of more cells per image, wider dynamic range means a field of variable intensity cells can be quantified in only one acquisition, and higher sensitivity results in reduced acquisition times. **GPU Express** for real time data processing.

For further information, view this article: highcontentreview.com/scmos/

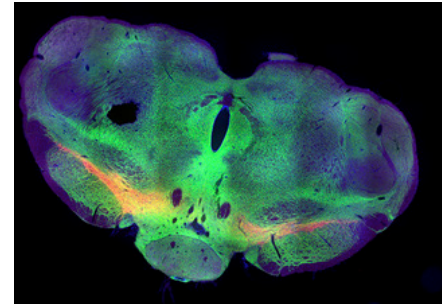

Mouse brain image courtesy of Simon C. Watkins and Victor Tapias, Center for Biologic Imaging, University of Pittsburgh.

Spinning Disk Confocal Microscopy

Often spinning disk solutions come equipped with two cameras technologies. Primarily, back-illuminated EMCCD cameras (see Andor iXon EMCCD range) with their superior sensitivity allowing for high quality imaging while preserving light intensity and label density at physiological levels, especially in conjunction with this particularly light-starved imaging modality. However, Zyla sCMOS is perfect for observations at large field of view of sample carrying relatively bright signals.

Wide Field Microscopy

The application of an array of fluorophores has made it possible to identify cells and sub-microscopic cellular components with a high degree of specificity among non-fluorescing material. In fact, the fluorescence microscope is capable of revealing the presence of a single molecule. Through the use of multiple fluorophores, different probes can simultaneously identify several target molecules. Although the fluorescence microscope cannot provide spatial resolution below the diffraction limit of specific specimen features, the detection of fluorescing molecules below such limits is readily achieved. The large field of view (4.2/5.5 MP), the broad spectral range, and the excellent resolution (6.5 μm) of sCMOS make it an ideal detector for wide-field fluorescence microscopy.

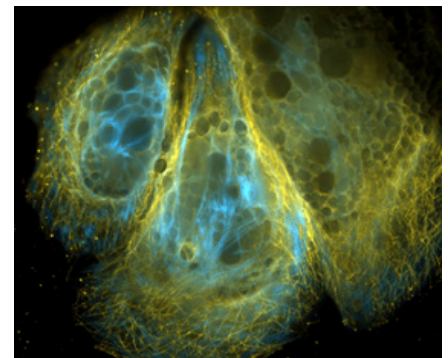
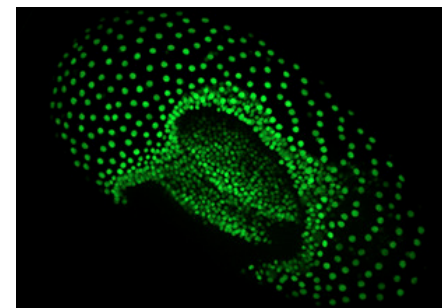

Image courtesy of Ulrike Engel, Nikon Imaging Center, Heidelberg. Embryonic muscle cells where actin starts to form contractile fibers (cyan). Microtubules are shown in yellow. Large unstained inclusions in the cytoplasm are yolk deposits.

Cell Motility Studies

The motile cell is captured extremely well by the speed and resolution of the Zyla. Generally, the rolling shutter of Zyla 4.2 PLUS is suited, but care must be taken of distortive effects if the cell is moving particularly fast. For example, it has been noted that the Zyla 5.5 in global shutter mode was required to image motile sperm cells.



Folding embryo image courtesy of Jeremy Lynch, Department of Biological Sciences, University of Illinois, Chicago.

TIRF Microscopy

The Zyla's fine pixel resolution, great sensitivity, large field of view and fast imaging speed offers a superb choice of platform for following/tracking fast processes at the cell membrane. Multi-wavelength TIRF may benefit from Zyla 5.5 in global shutter.

Upgrade your microscope performance using Zyla sCMOS

Zyla remains within the same price bracket as interline CCDs, yet offers remarkable performance improvements:

- 4x more pixels
- 5x more sensitive
- 10x more dynamic range
- 16x faster

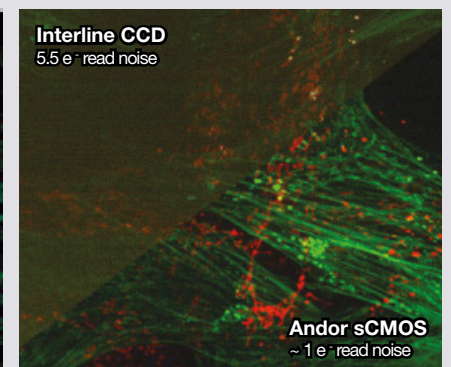
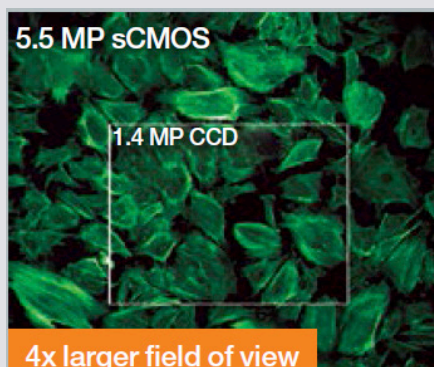

ROLLING & GLOBAL SHUTTER

The **Zyla 5.5** uniquely offers both Rolling and *true* Global Shutter exposure modes. This provides superior application and synchronization flexibility and the ability, through global exposure, to closely emulate the familiar ‘Snapshot’ exposure mechanism of interline CCDs.

Key Benefits of *True* Global Exposure

Global exposure in particular is viewed as an important mode for the biologist, as its benefits are deeply synergistic with the core imaging requirements of live cell microscopy.

- **NO Spatial Distortion** – avoiding the spatial distortion risk of rolling exposure
- Recommended for **3D / 4D microscopy** – Tight syncing to **peripheral switching devices**
- **Higher Signal to Noise** due to **reduced dead time** – the entire exposure cycle can be used
- **Simplicity** – all the benefits of an ‘**interline exposure mode**’
- **Continuous or Pulsed** light sources
- **Sub-microsecond inter-frame gaps** in **PIV applications**

‘Simulated’ Global Exposure in Zyla 4.2 PLUS

[Click here](#) to read more about this mode and other Frequently Asked Questions on Rolling and Global Exposure modes.

Rolling & Global Shutter Mechanisms

Rolling and *true* Global Shutter modes describe two distinct types of exposure and readout sequence.

In rolling shutter, available in Zyla 4.2 PLUS and Zyla 5.5, different lines of the array are exposed at different times as the read out ‘wave’ sweeps through the sensor. 10 ms is required at the start to ‘activate’ the sensor to expose, and then 10 ms is required at the end to readout the sensor. Use when not synchronizing to peripheral devices AND only when there is a minimal risk of spatial distortion from moving samples.

In *true* global shutter, available in Zyla 5.5, each pixel in the sensor begins the exposure simultaneously and ends the exposure simultaneously. This provides a true ‘Snapshot’ exposure capability for moving samples that is both ‘photon-efficient’ and easy to synchronize to, especially useful for 3D / 4D microscopy. Zyla 4.2 PLUS, while utilizing a rolling shutter sensor, offers a *Simulated* Global Exposure mechanism to overcome risk of spatial distortion. This mechanism is more elaborate and less photon/time efficient than *true* Global Shutter.

[Click here](#) to read more about Rolling and Global shutter modes on our Zyla camera.

Global Shutter exposure and readout (single scan)

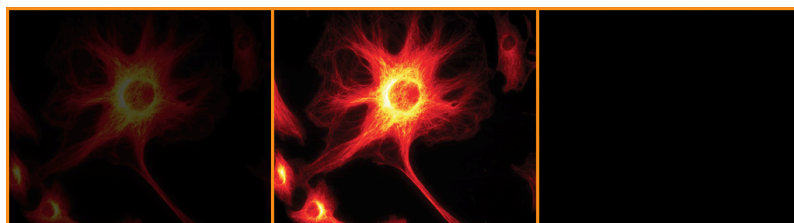

Exposure Start

Exposure

Exposure End

Rolling Shutter exposure and readout (single scan)

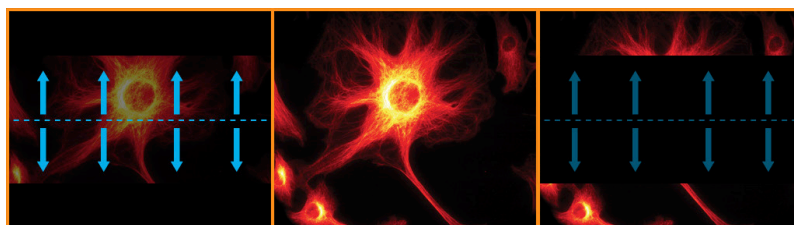

Exposure Start

Exposure

Readout

For further information of Rolling and Global Shutter, please access the following technical notes through the Andor Learning Centre: 1) Rolling and Global Shutter 2) Synchronizing to Rolling and Global Shutter sCMOS cameras

LightScan PLUS for Zyla 4.2 PLUS

Key Benefits:

- independent control of scan row height (‘slit height’) and line scan speed.
- optimize signal to noise AND confocality concurrently
- scan synchronization output for easy syncing to laser beam

CycleMax

- maximum frame rates with reduced dead-time, no need to reset scan laser for each alternate frame

[Click here](#) to find out more about LightScan PLUS.

Simultaneous Readout Direction Options

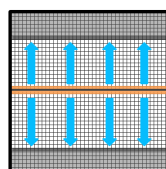

Center Out

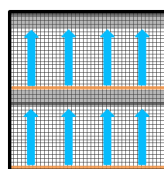

Bottom Up

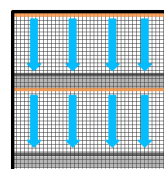

Top Down

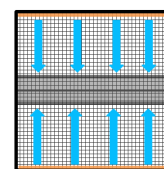

Outside In

Sequential Readout Direction Options

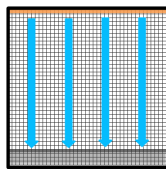

Top Down

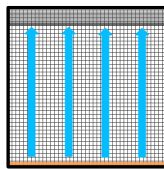

Bottom Up

sCMOS or EMCCD?

Since the market introduction of **sCMOS** technology by Andor, the question of the performance comparison against the more established **Electron Multiplying CCD (EMCCD)** has been common.

Being a very fast, low noise technology, sCMOS does hold some potential to offer an alternative technology to these single photon sensitive detectors across some applications and techniques, including to an extent, super-resolution microscopy and TIRF microscopy. Whilst the read noise of sCMOS is very low compared to CCDs, EMCCD technology holds the distinct advantage of being able to practically eliminate read noise, rendering them single photon sensitive.

After the first few years of sCMOS being in the market, we are concluding that the primary applications for which EMCCDs were originally purchased, such as single molecule detection and low light spinning disk confocal microscopy, are continuing to benefit from this ultrasensitive technology. EMCCDs offer a raw sensitivity that cannot be surpassed in the very low light regime. However, EMCCDs remain relatively expensive, so they will always be considered a more selective, 'high-end' solution.

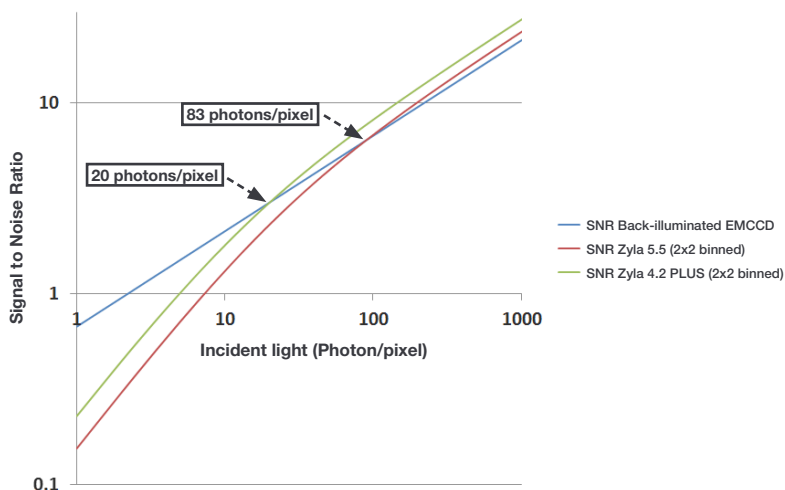

Figure 1

Plot of Signal to Noise Ratio versus Incident Photon Intensity, comparing back-illuminated EMCCD iXon 888 (13 μm pixel size) to 2x2 binned Zyla sCMOS cameras (13 μm pixel size after binning). An average QE value for each sensor between 500-750 nm was used.

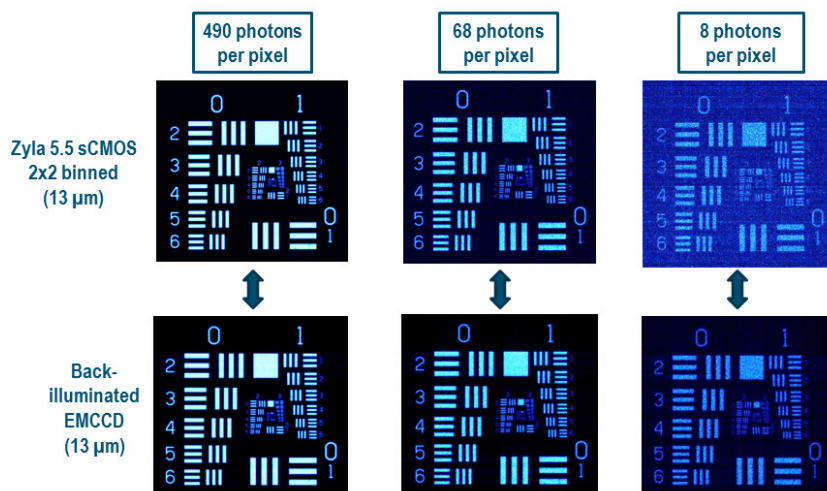

Figure 2

Images at a range of incident light intensity, acquired using back-illuminated EMCCD iXon 888 and Zyla 5.5 sCMOS cameras (2x2 binned pixels). At low light intensities, the Signal to Noise Ratio advantage of the EMCCD is apparent.

TECHNICAL SPECIFICATIONS

MODEL SPECIFIC SPECIFICATIONS^{*1}

Model	Zyla 5.5	Zyla 4.2 PLUS
Sensor type	Front Illuminated Scientific CMOS	Front Illuminated Scientific CMOS
Active pixels (W x H)	2560 x 2160 (5.5 Megapixel)	2048 x 2048 (4.2 Megapixel)
Sensor size	16.6 x 14.0 mm 21.8 mm diagonal	13.3 x 13.3 mm 18.8 mm diagonal
Pixel readout rate (MHz)	200 (100 MHz x 2 sensor halves) 560 (280 MHz x 2 sensor halves)	Slow Read 216 (108 MHz x 2 sensor halves) Fast Read 540 (270 MHz x 2 sensor halves)
Read noise (e⁻) Median [rms] ^{*2}	Rolling Shutter	Rolling Shutter
	@ 200 MHz 0.9 [1.2] @ 560 MHz 1.2 [1.6]	Global Shutter 2.3 [2.5] 2.4 [2.6]
Maximum Quantum Efficiency ^{*3}	60%	82%
Sensor Operating Temperature		
Air cooled	0°C (up to 30°C ambient)	0°C (up to 27°C ambient)
Water cooled	-10°C*	-10°C*
Dark current, e⁻/pixel/sec @ min temp ^{*4}		
Air cooled	0.10	0.10
Water cooled	0.019	0.019
Readout modes	Rolling Shutter and True Global Shutter (Snapshot)	Rolling Shutter and Global Clear ^{*8}
Maximum dynamic range	33,000:1	33,000:1
Photon Response Non-Uniformity (PRNU)		
Half-light range		< 0.01%
Low light range		< 0.1%
Pre-defined Region of Interest (ROI)	2048 x 2048, 1920 x 1080, 1392 x 1040, 512 x 512, 128 x 128	1920 x 1080, 1392 x 1040, 512 x 512, 128 x 128
User defined ROI (Granularity)	Yes (1 pixel) ^{**}	
Data range	12-bit (fastest USB 3.0 speeds) and 16-bit (maximum dynamic range)	
Interface options	USB 3.0 ^{*9} Camera Link 10-tap	

* Cooling temperature must be above the dew point

** Minimum ROI size: 4 x 8 (W x H) possible for 12- or 16-bit modes and for both Camera Link 10-tap and USB 3.0 models

GENERAL SPECIFICATIONS^{*1}

Pixel size (W x H)	6.5 µm
Pixel well depth (e⁻)	30,000
Linearity (% , maximum) ^{*5}	
Full light range	Better than 99.8%
Low light range (< 1000 electrons signal)	Better than 99.9%
MTF (Nyquist @ 555 nm)	45%
Pixel binning	Hardware binning: 2 x 2, 3 x 3, 4 x 4, 8 x 8
Anti-blooming factor	x 10,000
I/O	External Trigger, Fire, Fire n, Fire All, Fire Any, Arm
Trigger Modes	Internal, External, External Start, External Exposure, Software Trigger
Software Exposure Events^{*6}	Start exposure - End exposure (row 1), Start exposure - End exposure (row n)
Hardware timestamp accuracy	25 ns
Internal memory	1 GB

FRAME RATE TABLE - 12-BIT (16-BIT)⁷

Array Size	Zyla 5.5 USB 3.0		Zyla 5.5 10-tap		Zyla 4.2 PLUS 10-tap	Zyla 4.2 PLUS USB 3.0
	Rolling Shutter	Global Shutter	Rolling Shutter	Global Shutter	Rolling Shutter	Rolling Shutter
2560 x 2160	40 (30)	40 (30)	100 (75)	49 (49)	-	-
2048 x 2048	53 (40)	52 (39)	105 (98)	52 (52)	101 (101)	53 (40)
1920 x 1080	107 (80)	98 (80)	200 (200)	97 (97)	192 (192)	107 (80)
512 x 512	422 (422)	201 (201)	422 (422)	201 (201)	406 (406)	406 (406)
128 x 128	1691 (1691)	716 (716)	1691 (1691)	716 (716)	1627 (1627)	1627 (1627)
2048 x 8 (FCS mode)	13020 (10250)	4008 (4008)	27057 (27057)	4008 (4008)	26041 (26041)	13020 (10250)
1024 x 8 (FCS mode)	27057 (27057)	4008 (4008)	27057 (27057)	4008 (4008)	26041 (26041)	26041 (26041)

QUANTUM EFFICIENCY (QE) CURVE ^{*3}

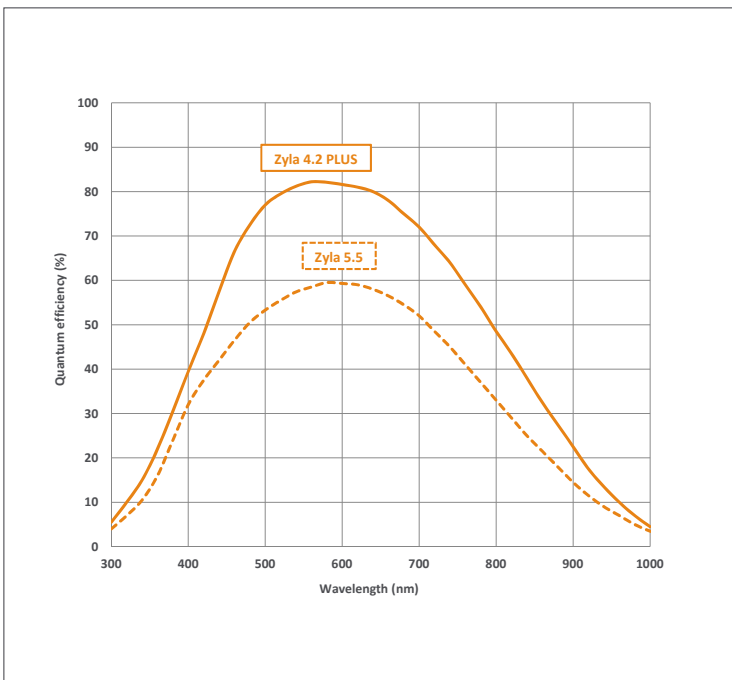

QE VS. FLUOROPHORE EMISSIONS

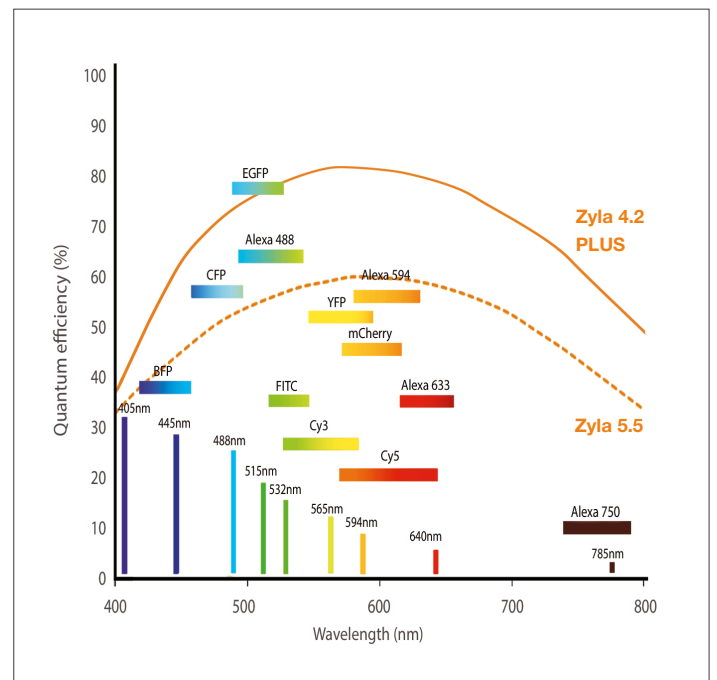

GPU Express



The Andor GPU Express library has been created to simplify and optimize data transfers from camera to a CUDA-enabled NVidia Graphical Processing Unit (GPU) card to facilitate accelerated GPU processing as part of the acquisition pipeline. GPU Express integrates easily with SDK3 for Windows, providing a user-friendly but powerful solution for management of high bandwidth data flow challenges; ideal for data intensive applications such as Light Sheet Microscopy, Super-Resolution Microscopy and Adaptive Optics.

- Enhanced convenience, afforded by simple, optimized GPU data management
- Optimal data throughput
- Superb, easily accessible documentation and examples.

CREATING THE OPTIMUM PRODUCT FOR YOU

Step 1. Select the camera type

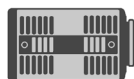

Camera Type

Description	Code
ZYLA 4.2 PLUS, 4.2 Megapixel, Rolling shutter, 100 fps, Camera Link 10-tap	ZYLA-4.2P-CL10
ZYLA 4.2 PLUS, 4.2 Megapixel, Rolling shutter, 53 fps, USB 3.0	ZYLA-4.2P-USB3
ZYLA 5.5, 5.5 Megapixel, Rolling and Global shutter, 100 fps, Camera Link 10-tap	ZYLA-5.5-CL10
ZYLA 5.5, 5.5 Megapixel, Rolling and Global shutter, 40 fps, USB 3.0	ZYLA-5.5-USB3

For water cooled option, add *-W* to your selected camera code

Step 2. Select the required accessories

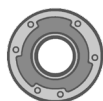

Accessories

Description	Order Code
CS-mount adapter	ACC-MEC-05609
F-mount adapter	ACM-05574
Auto extension tubes (set of 3) for C-mount	OA-ECMT
Auto extension tubes (set of 3) for Nikon F	OA-ENAF
Re-circulator for enhanced cooling performance	XW-RECR
Oasis 160 Ultra compact chiller unit	ACC-XW-CHIL-160
7-way Multi I/O timing cable, offering Fire, External Trigger, Shutter and Arm. 3 meter.	ACC-ACZ-05612
PC Workstation for up to 100 fps continuous spooling to hard drives, acquiring up to 120,000 12-bit full resolution images: Dell T7910XL, 2.6 GHz Eight Core, 8 GB RAM, 4 x 250GB SSD hard drive configured in RAID 0.	WKST-1 WIN
PC Workstation for up to 100 fps continuous spooling to RAM, acquiring up to 6,000 12-bit full resolution images: Dell T5810, 3.5 GHz Quad Core, 64 GB RAM.	WKST-3 WIN

For further information on PC workstations for Zyla, please refer to the technical note [PC Specifications for sCMOS](#)

Step 3. Select the required software



Software

The Zyla also requires at least one of the following software options:

Solis Imaging A 32-bit and fully 64-bit enabled application for Windows (7, 8, 8.1 and 10) offering rich functionality for data acquisition and processing. AndorBasic provides macro language control of data acquisition, processing, display and export.

Andor iQ A comprehensive multi-dimensional imaging software package. Offers tight synchronization of the camera with a comprehensive range of microscopy hardware, along with comprehensive rendering and analysis functionality. Modular architecture for best price/performance package on the market.

Andor SDK3 A software development kit that allows you to control the Andor sCMOS cameras from your own application. Available as 32 and 64-bit libraries for Windows (7, 8, 8.1 and 10) and Linux. Compatible with C/C++, LabView and Matlab.

GPU Express Andor GPU Express library has been created to simplify and optimize data transfers from camera to a CUDA-enabled NVidia Graphical Processing Unit (GPU) card to facilitate accelerated GPU processing as part of the acquisition pipeline. Integrates easily with Andor SDK3 for Windows.

Third party software compatibility

Drivers are available so that the Zyla can be operated through a large variety of third party imaging packages. See Andor web site for detail: andor.com/software/

PRODUCT DRAWINGS

Dimensions in mm [inches]

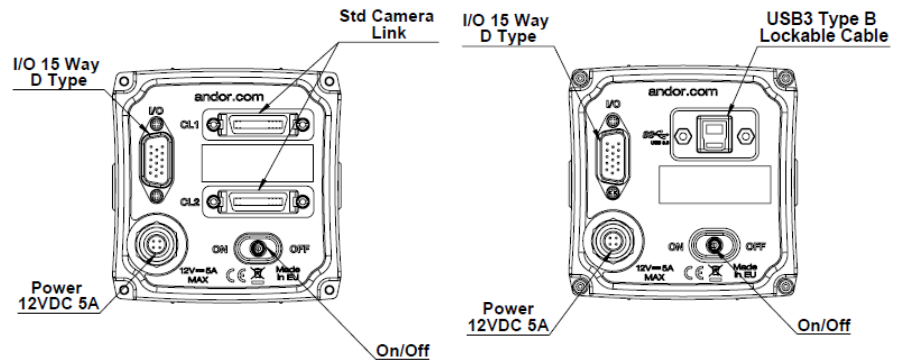
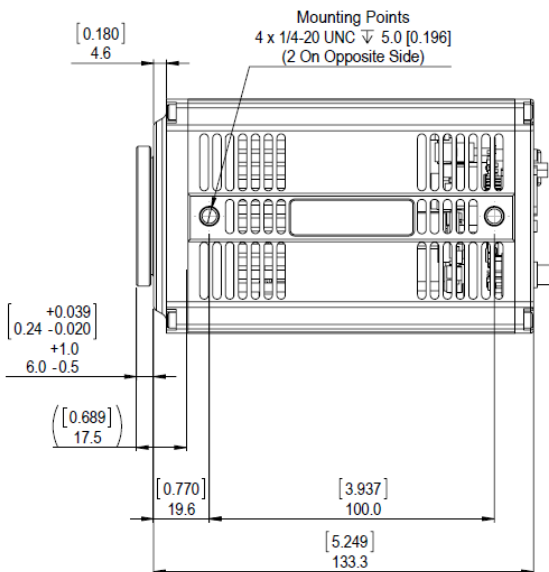
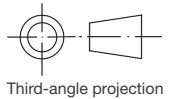

Note: Please leave 70mm minimum for the bend radius of the USB 3.0 cable.

Weight: 1,000 g [2 lbs 3 oz]

Product drawings of the water cooled Zyla can be found at <http://www.andor.com/watercooledzyla>

CONNECTING TO THE ZYLA

Camera Control

Connector type: 3 meter Camera Link 10-tap connectors or USB 3.0. (Longer lengths available as accessories).

TTL / Logic

1 x 3-way Multi I/O timing cable, offering Fire, External Trigger and Arm (1.5 meter)

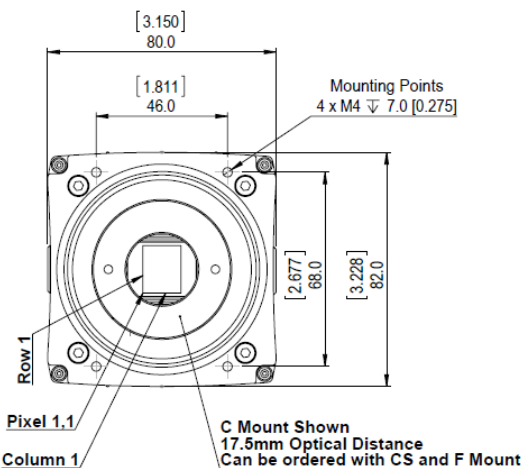

REGULATORY COMPLIANCE

- RoHS compliant
- EU EMC Directive
- EU LV Directive
- IEC 61010-1 CB Scheme

EXTERNAL POWER SUPPLY COMPLIANCE

- UL-certified for Canada and USA
- Japanese PSE Mark

POWER SUPPLY REQUIREMENTS

- Power: +12 VDC \pm 5% @ 5A
- Ripple: 200 mV peak-peak 0 - 20 MHz
- 100 - 240 VAC 50/60 Hz external power supply
- Power Consumption: 12V @ 5A Max, 12V @ 2.5A Nominal

15-WAY D-TYPE PINOUTS

1	ARM	Output
2	Aux_Out_1*	Output
3	FIRE row n	Output
4	FIRE row 1	Output
5	Aux_Out_2	Output
6	Ground	GND
7	External Trigger	Input
8	Spare Input	Input
9	Reserved	N/A
10	Reserved	N/A
11	Reserved	N/A
12	Reserved	N/A
13	Reserved	N/A
14	Reserved	N/A
15	Reserved	N/A

* Aux_Out_1 is configurable as Fire, Fire n, Fire All or Fire Any. Refer to the Zyla hardware manual.



ORDER TODAY

Need more information? At Andor we are committed to finding the correct solution for you. With a dedicated team of technical advisors, we are able to offer you one-to-one guidance and technical support on all Andor products. For a full listing of our regional sales offices, please see: andor.com/contact

Our regional headquarters are:

EUROPE

Belfast, Northern Ireland
Phone +44 (28) 9023 7126
Fax +44 (28) 9031 0792

JAPAN

Tokyo
Phone +81 (3) 6732 8968
Fax +81 (3) 6732 8939

NORTH AMERICA

Concord, MA, USA
Phone +1 (860) 290 9211
Fax +1 (860) 290 9566

CHINA

Beijing
Phone +86 (10) 8271 9066
Fax +86 (10) 8271 9055

ITEMS SHIPPED WITH YOUR CAMERA

For Camera Link 10-Tap Models: 1 x Camera Link Card and 2 x 3 meter connector cables.

For USB 3.0 models: 1 x USB 3.0 PCIe Card and 1 x 3 meter USB 3.0 cable (Type A to B)
1 x Power supply with mains cable
1 x 3-way Multi I/O timing cable, offering Fire, External Trigger and Arm (1.5 meter)
1 x Quick Start Guide
1 x CD containing Andor user guides
1 x Individual system performance sheet

Front cover image courtesy of Gopi Shah, Max Planck Institute of Molecular Cell Biology and Genetics, Dresden. Light-sheet fluorescence microscopy imaging of Zebrafish embryo gastrulation from 4 to 18 hours post-fertilization, where each cell nucleus is labelled with GFP. Cells are color-coded for depth to visualize how dynamic cell reorganization gives rise to the body axis of zebrafish.

FOOTNOTES:

- Specifications are subject to change without notice
- Figures are typical unless otherwise stated.
 - Readout noise is for the entire system and is taken as a median over the sensor area excluding any regions of blemishes. It is a combination of sensor readout noise and A/D noise.
 - Quantum efficiency of the sensor at 20°C as supplied by the manufacturer.
 - Dark current measurement is taken as a median over the sensor area excluding any regions of blemishes.
 - Linearity is measured from a plot of Signal vs. Exposure Time, in accord with EMVA 1288 standard.
 - Software Exposure Events provide rapid software notification (SDK only) of the start and end of acquisition, useful for tight synchronization to moving peripheral devices e.g. Z-stage.
 - The maximum frames/s table for Zyla indicate the maximum speed at which the device can acquire images in a standard system at full frame and also a range of sub-array size, for both rolling and global shutter readout modes (Zyla 5.5), 12-bit single amplifier (rates also apply to dual amplifier 16-bit for Zyla 4.2). Note that the write speed of the PC hard drive can impose a further restriction to achieving sustained kinetic series acquisition.
 - 'Global Clear' is an optional keep clean mechanism that can be implemented in rolling shutter mode, which purges charge from all rows of the sensor simultaneously, at the exposure start. The exposure end is still rolling shutter. It can be used alongside the Fire All output of the camera and a pulsed light source to simulate Global Exposure mechanism, albeit less efficiently than the true Global Shutter exposure mode of Zyla 5.5. Furthermore Global Clear differs from true Global Shutter in that it can only be used in 'non-overlap' readout mode, i.e. sequential exposure and readout phases rather than simultaneous.
 - Zyla USB 3.0 models should work with any modern USB 3.0 enabled PC/laptop (provided hard drives or RAM is sufficient to support data rates) as every USB 3.0 port should have its own host controller. Zyla USB 3.0 models also ship with a USB 3.0 PCI card as a means to add a USB 3.0 port to an older PC, or as a diagnostic aid to interoperability issues or to ensure maximum speed.

MINIMUM COMPUTER REQUIREMENTS:

- 2.68 GHz Quad Core
 - 4GB RAM (increase RAM if to be used for continuous data spooling)
 - Hard Drive:
Minimum 450 MB/s continuous write for USB 3.0 models
Minimum 850 MB/s continuous write for Camera Link 10-tap models
 - PCI Express x4 or greater for USB 3.0 models
 - PCI Express x8 or greater for Camera Link 10-tap models
 - Windows (7, 8, 8.1 or 10) or Linux
- * See technical note entitled: 'PC Specifications for sCMOS'
** Note, Andor supply PC workstations for Zyla, see page 10.

Operating and Storage Conditions

- Operating Temperature:
Zyla 5.5: 0°C to 30°C ambient
Zyla 4.2: 0°C to 27°C ambient
- Relative Humidity: < 70% (non-condensing)
- Storage Temperature: -10°C to 50°C

Power Requirements

- Please refer to page 11



Windows is a registered trademark of Microsoft Corporation

LZYLA5 0517 R1