



Accelerating Rate Calorimeters

Advanced Solution for Chemical Process Safety,
Energetic Material, and Battery Development

Best-in-Class Adiabatic Calorimetry

ADIABATIC CALORIMETRY

*A Key Tool to Understand
Thermal Runaway*



ARC® 244

Adiabatic calorimetry has been the cornerstone of chemical process safety for the last 30 years. More recently, adiabatic calorimetry has been widely used in measuring the potential of thermal runaway of Li-ion cells. These cases are similar in that they require measuring both the amount of heat released (thermodynamics) and the rate at which the heat is released (kinetics). In both cases, there can be a significant increase in sample pressure and the combination of the temperature and pressure rise can lead to an explosion. Therefore, adiabatic calorimeters are generally designed to be much more robust than many other types of calorimeters.

When looking at a thermal runaway, whether it is within a battery cell or part of a chemical process in a reactor, the reaction produces heat which increases the temperature of the reaction mixture and further increases the rate of reaction. There can come a point when the rate of heat release from the reaction exceeds the rate at which the heat can be lost to the surrounding environment – the point at which thermal runaway starts. Obviously, the worst case is when there is little or no ability for the heat to be lost to the environment. Any heat, even small amounts of heat, cause the temperature to rise and accelerates the reaction producing even more heat. This is the adiabatic condition and it is this precise condition that adiabatic calorimeters can safely measure in the small scale. It is this same condition that can be found inside large processing vessels as well as inside a Li-ion pack running inside a laptop computer.

NETZSCH – a New Level of Adiabatic Calorimetry

The adiabatic principle is realized in accelerating rate calorimeters. The instruments described herein are the best in their class. With the patented *VariPhi*[®] system, not only can adiabatic test be done more accurately but it also opens up new areas of calorimetry not possible with the original ARC[®] units. The systems have been enhanced to do more and answer more questions.



ARC[®] 254

Method

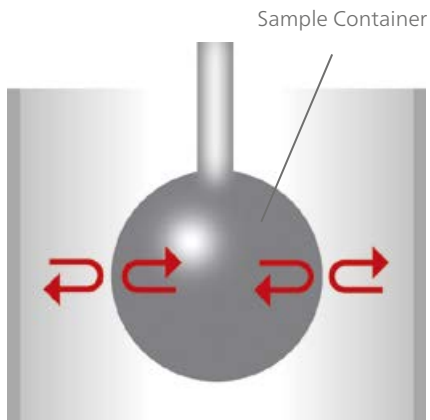

Adiabatic System: No heat in – no heat out

The energy release from chemical reactions (decomposition, etc.) is a point of focus in chemical research, battery research and other industries. When energy is generated by a thermally induced chemical reaction and the heat transfer to the outside is smaller than the generated amount, runaway reactions can occur. In the worst case, this can cause catastrophic effects (explosions). Adiabatic calorimeters are ideal tools for analyzing such questions as they simulate the worst case scenario with no heat exchange with the surroundings. The behavior in real large scale chemical reactors can therefore be simulated.

For decades accelerating rate calorimeters have been widely used by researchers in this field, offering the capability to measure temperatures, enthalpy changes and pressure changes quantitatively.

Technique

A sample (several grams) is placed in a spherical vessel. The vessel is surrounded by a sophisticated heating system. Depending on the working mode, the surroundings of the vessel are controlled to the same temperature as the sample. If there is no temperature difference between the heaters and the sample, then all the heat generated by the sample stays within the sample. This is the adiabatic condition.

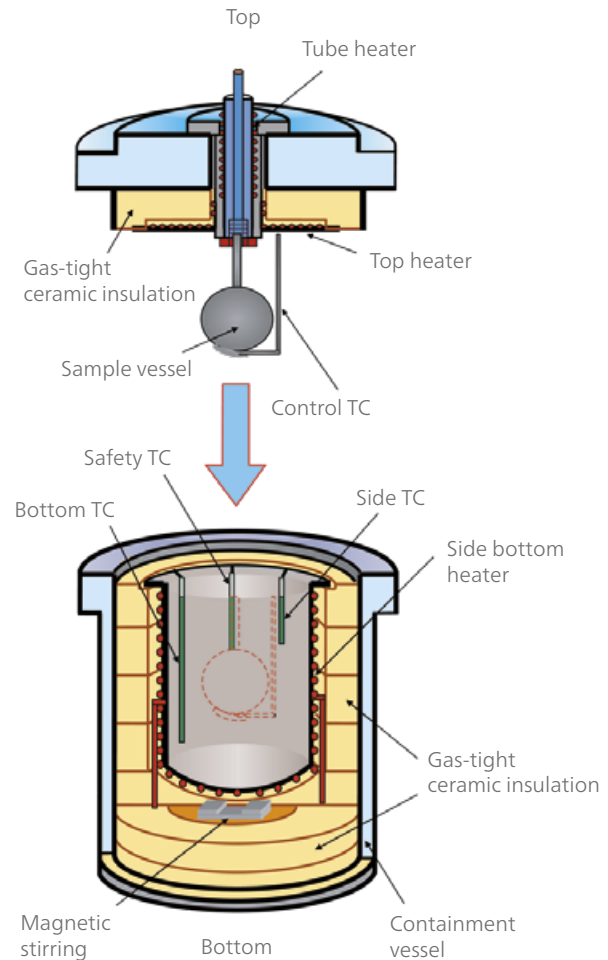

Schematic of the ARC® 254 Calorimeter Assembly
TC = Thermocouple

Understanding Adiabatic Reaction Calorimetry

Heat-Wait-Search mode (HWS) represents a careful approach to the reaction temperature:

- Heating the sample material to a certain temperature → Heat
- Isothermal stabilization → Wait
- Change to the adiabatic mode → Search (as soon the self-heating rate of the sample extends a customer-defined threshold (usually 0.02 K/min))

Measurement Results

A thermal runaway reaction is usually investigated with the Heat-Wait-Search mode (HWS). The temperature of reaction as well as the temperature and pressure increase are measured. Additionally, the temperature and pressure increase rates can be determined. These are important values in order to characterize the worst case scenario of a substance.

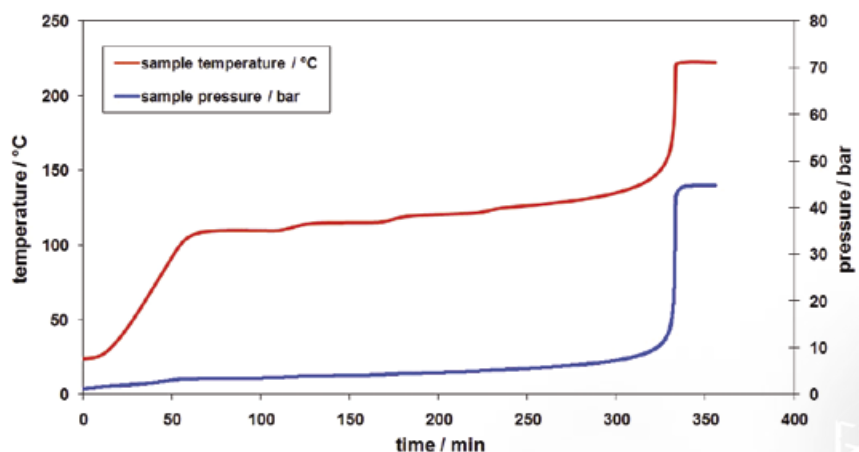

Thermal runaway reaction of a 20% solution of di-tert. butyl peroxide (DTBP) in toluene.

*The Original DOW Design
for Basic ARC[®] Testing*

Accelerating Rate Calorimeter ARC[®] 244

The cost-effective ARC[®] 244 is designed to safely measure the amount and rate of heat release associated with the processing or storage of chemicals with a sample volume of 0.5 ml to 7 ml. This is the only calorimeter which uses the same design as the first ARC[®] system developed by DOW for those customers interested in keeping the same platform.

The key features are high performance, safety, usability, and flexibility with data integrity and robustness in a temperature range from ambient to 500°C.



ARC[®] 244



ARC® 244 Calorimeter Assembly

Operating Modes

- Heat-Wait-Search test for thermal runaway reactions
- Iso-Fixed/Iso-Track for studying storage conditions/auto-catalytic reactions (iso-aging technique)
- Ramp mode for fast screening of unknown samples

Optionally with *VariPhi*®

Scanning and isothermal modes allow detection of exothermic and endothermic effects; similar to the DSC method

Features	Advantages	Benefits
Motorized headlift	operator not required to lift calorimeter lid and can set working height based on personal preference	Easy for all operators to use safely and quickly
Over-temperature protection	one safety thermocouple monitors calorimeter temperatures and shuts down the system independent of the software	Protects heaters and other instrument parts from runaways
Tube heater	heats the pressure transfer tube to the same temperature as the sample	Prevents refluxing and sample loss which can cause great underestimation of heats of reaction and temperature and pressure rates
Iso-fixed mode	allows the user to run isothermal aging tests for many days with minimized drift	More accurate and reliable data
Automated anneal, temp.	the user can quickly set-up the anneal-adjustment-drift test sequence. The software will automatically go from one test to the next	No operator intervention necessary, improved efficiency

*Advanced Technology
for Specialized Testing*

Accelerating Rate Calorimeter ARC[®] 254

The advanced Accelerating Rate Calorimeter ARC[®] 254 helps engineers and scientists identify potential hazards and tackle key elements of process optimization and thermal stability. As a highly versatile, miniature chemical reactor, sample can be stirred, material injected, and it can be used for vent studies. The ARC[®] 254 has been designed to use the traditional 10 ml ARC spherical vessel but can also use the larger 130 ml vessel for low Phi or vent testing.



ARC[®] 254



Operating Modes

- Heat-Wait-Search test for thermal runaway reactions of chemicals or battery samples
- Iso-Fixed/Iso-Track for studying storage/conditions/auto-catalytic reactions (iso-aging technique)
- Ramp mode for screening unknown samples

Optionally with *VariPhi*[®]

- Scanning and isothermal modes allow detection of exothermic and endothermic effects; similar to the DSC method
- In-situ battery cycling using isothermal calorimeter mode

Features*	Advantages	Benefits
Temperature tracking rate up to 200 K/min	fast reactions can be tracked without the need to increase thermal inertia	More reliable data and wider application range
Machined gas-tight ceramic insulation	provides consistent insulation properties (i.e. density, geometry)	Constant insulation properties provide for accurate test results, easy cleaning
True temperature calibration	with <i>VariPhi</i> [®] temperature measurements can be corrected to standards	More accurate onset temperature
Battery holder (D-cell, 18650, pouch cell)	Testing of battery or charging/discharging battery	Easy testing of different batteries

* in addition to ARC[®] 244 features

The basis of the *VariPhi*[®] is an additional controlled variable DC heater. With this option, it is possible to define the thermal inertia in order to allow real-world thermal environment by compensating for heat lost from the sample to the vessel. By operating different modes such as isothermal or scanning, endothermic and exothermic transitions can be quantified and pressure data can be measured.

VariPhi[®]

A Patented Solution for Low Phi Operation and Reduced Testing Time

Theory

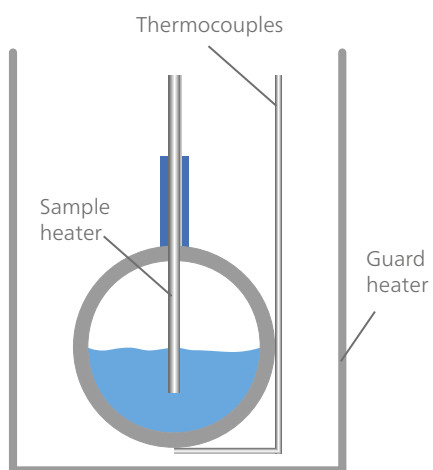

Diagram of *VariPhi*[®]

Sample containers absorb some of the energy from the reaction. How much heat is absorbed depends upon the mass and heat capacity of the sample container. The ratio between the product of the system (sample + vessel) and heat capacity to the product of the container mass and heat capacity is what is known as thermal inertia.

When the sample mass is large compared to the container mass, the thermal inertia approaches one. These tests are often called “low phi” tests. They are important because most industrial scale processing or storage conditions are low thermal inertia conditions. The mass of a large storage container is very small compared to the mass of the stored material. Since this is not always true, it is important to be able to run multiple tests at varying thermal inertia. The *VariPhi*[®] gets its name because the user can quickly and easily run low and high thermal inertia (“Phi”) tests in the same calorimeter using a small and inherently safer sample size.

Formula for thermal inertia (Φ -factor) according to ASTM E1981:

$$\Phi = \frac{(m_s \cdot C_{p,s} + m_c \cdot C_{p,c})}{m_s \cdot C_{p,s}} \quad \Phi = 1 + \frac{m_c \cdot C_{p,c}}{m_s \cdot C_{p,s}}$$

m_c = mass of the container
 $C_{p,c}$ = heat capacity of the container
 m_s = mass of the sample
 $C_{p,s}$ = heat capacity of the sample

Standard Modes such as Heat-Wait-Search, Iso-Fixed or Iso-Track

- Compensation for heat lost to the sample container during test
- Thermal inertia or Phi (Φ) factor can be defined
- Low Phi testing with small samples

Scanning Mode

- Reduces test time by 75% or more without loss of sensitivity
- Endothermic transition can be accurately measured

Fire-Exposure Mode

Simulation of additional heat to the sample during external fire scenario

Isothermal Mode

- True isothermal calorimeter mode is possible on chemical samples and battery cells
- 3D battery sensors are available based on the *VariPhi*[®] concept. They allow the study of charge/discharge of batteries inside the calorimeter



Testing Vessels for the Accelerating Rate Calorimeters

A broad variety of testing vessels are available to meet different test requirements. Tube-type vessels are available for running energetic materials and for use with solids and pastes in the *VariPhi*[®] mode. For battery testing, specific holders are designed for common commercial sizes. Custom vessels can also be designed.

Materials

- Spherical vessels with a wall thickness between 0.4 mm and 5.1 mm are made of glass, Hastelloy, Inconel, stainless steel, tantalum and titanium
- Tube-type vessels with a wall thickness of 0.4 mm and 0.7 mm are made of stainless steel and titanium

Volume

- 1 ml to 130 ml for spherical vessels
- 0.1 ml to 9 ml for tube-type vessels



	ARC® 244	ARC® 254
Temperature range	RT to 500°C	RT to 500°C
Pressure range (Standard)	0 bar to 200 bar	0 bar to 200 bar
Lift mechanism	motorized	motorized
Typical sample volume*	0.5 ml to 7 ml	0.5 ml to 8.5 ml
Max. tracking rate	20 K/min	200 K/min
Temperature reproducibility	0.1 K	0.1 K
VariPhi®	Optional	Optional
Operating mode	<ul style="list-style-type: none"> ■ Heat-Wait-Search ■ Constant heating rate ■ Isothermal 	<ul style="list-style-type: none"> ■ Heat-Wait-Search ■ Constant heating rate ■ Isothermal
Stirring	Optional	Optional
Injection	Optional	Optional
Venting	Optional	Optional
Accessory for battery test	–	<ul style="list-style-type: none"> ■ Thermal runaway ■ Isothermal ■ Cycling
Low Φ factor	Yes, pressure-dependent**	Yes, pressure-dependent**
Kinetics software	Optional	Optional
Applications	<ul style="list-style-type: none"> ■ Process Safety ■ Comparison to legacy data 	<ul style="list-style-type: none"> ■ Process Safety ■ Battery ■ Energetic Materials

* Sample volumes shown are typical and not limits. The choice of sample vessels can influence test results. See product manual or spare parts list for more details.

** Dependent on sample pressure built-up

Technical Specifications

Configurable Options to Match Testing Needs

ARC[®]244 options

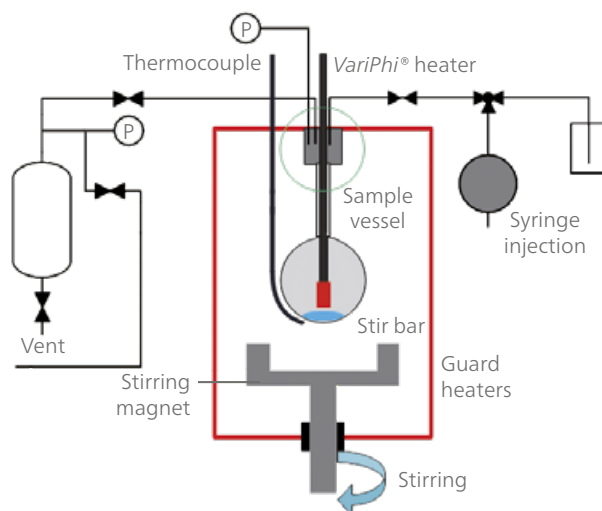

ARC[®]254 options

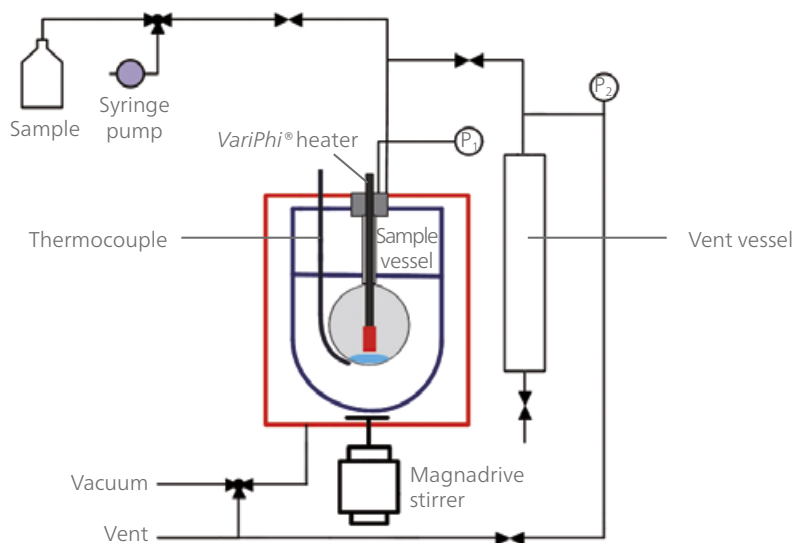

Selecting the Best Calorimetry for Your Applications

Intelligent Software Solutions

Measurement Task

The measurement software for the Accelerating Rate Calorimeters offers easy setup of a measurement, selection of the measurement mode and follow-up of the test progress. All raw data signals are accessible on the screen, switches can be set with one mouse click and simple plots of the running measurements can be generated. The software stores data in binary and ASCII formats, making it easy to load results into other software packages for advanced analysis.



- Software automatically customizes itself to the instrument and application
- Intuitive Windows set-up of testing methods with input checks to reduce typos
- Methods can be saved and recalled for later use
- Online help, comprehensive and easy to understand, available throughout the software
- Data is automatically saved to hard-drive throughout the run
- Intelligent firmware monitors the status and health of key operating sensors and active components
- Safety integrated with hardware and firmware controls
- Seamless integration of data files to *Proteus*®
- Analysis, NETZSCH Advanced Software Tools

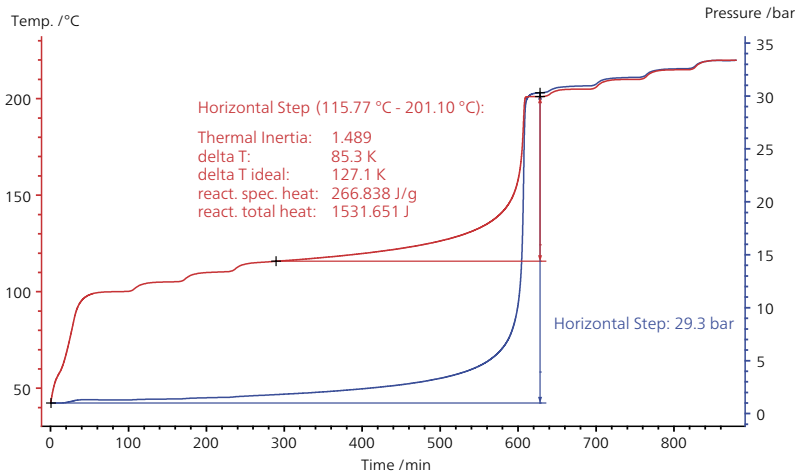

Screenshot of the *Proteus*® evaluation software

Evaluation Software

Analysis of the measurements is done using the well-known *Proteus*® Thermal Analysis software. Presentation of measurement results such as various temperatures, heat generation rates or the pressure development can be done in one plot. Direct evaluation of decomposition enthalpies and standard kinetic analysis is possible.

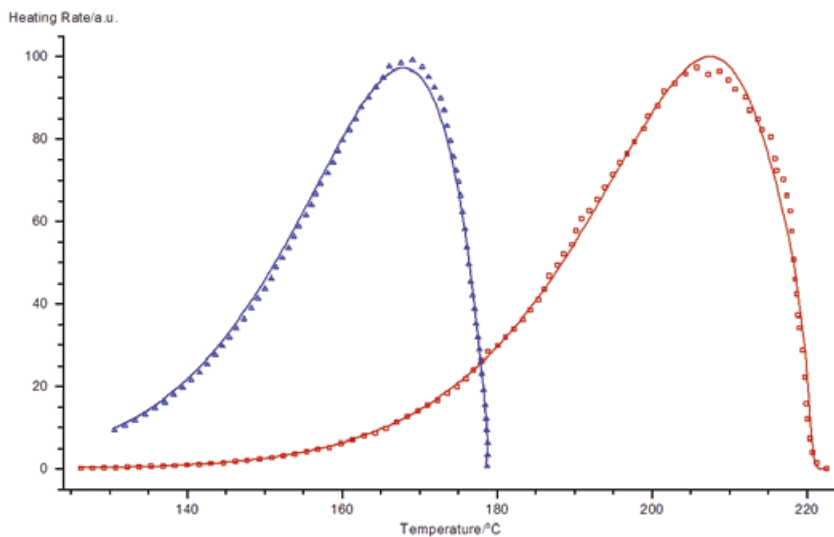

Comparison of measured and calculated data for different phi-factors

Advanced Thermokinetic and Thermal Simulation

Most decomposition reactions cannot be explained by simple kinetic approaches. In such cases, the nature of a reaction is based on various steps (consecutive, parallel or competitive reactions). Multiple step reactions with more than 15 different reaction types can be used in NETZSCH *Thermokinetics* for the analysis of the results. This is the ideal tool for understanding the real chemistry and kinetics behind a reaction.

Typical Applications

Accelerating Rate Calorimeters by NETZSCH can be used for the Thermal Analysis of solid or liquid chemicals or for gas/liquid, liquid/liquid, gas/solid, and liquid/solid mixtures. They can also be used for process simulation of batch and semibatch reactions, fire exposures, emergency relief venting, and physical properties measurement.

Energetic Materials

Ammonium nitrate is a base material for various applications, such as fertilizers. Measured here are solid-state phase transitions and melting (at 166°C) as well as the decomposition behavior, starting at 221°C. Such tests are crucial for safety studies on such highly energetic materials.

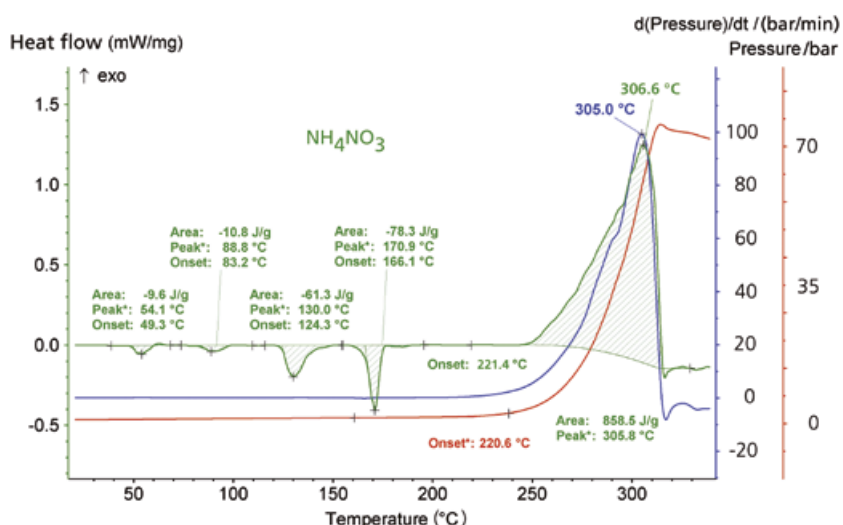

Analysis of the phase changes and decomposition behavior of ammonium nitrate using the *VariPhi*® option

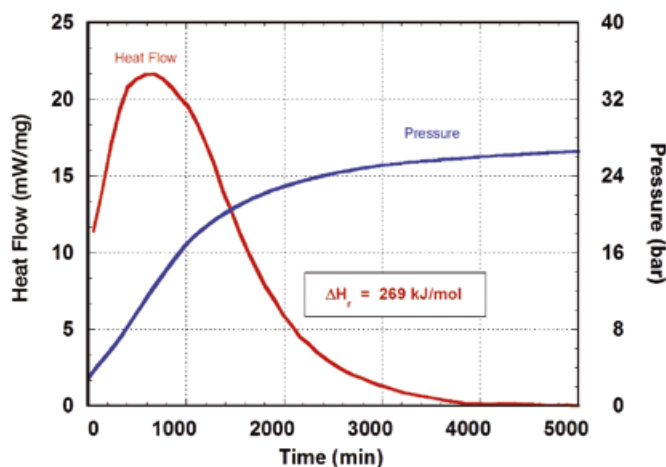

Autocatalytic behavior of 3 g 3-methyl-4-nitrophenol at 180°C (isothermal)

Autocatalytic Behavior

3-methyl-4-nitrophenol displays autocatalytic behavior when heated to decomposition temperatures. This may be studied using the Iso-Track or Iso-Fixed feature of the calorimeter control software. Using the *VariPhi*® option allows measurement of the sample under true isothermal conditions. The plot shows the autocatalytic nature of the material where the sample heat flux initially increases and then decreases due to consumption of reactant. The total heat release during decomposition is simply obtained by integration of the heat flux signal.

Vented Tests

All ARC[®]s may be operated in vented or open vessel mode. For vented tests, a computer-controlled valve is opened which allows material to flow to a 500 ml dropout pot. If the pressure in the reaction vessel ceases to rise and the sample temperature remains flat or is tempered, then the reaction may be classified as a vapor system. The pressure in the reaction vessel may continue to rise, but at a reduced rate because of the increase in the head space of the reaction vessel. At the end of the test, the contents of the drop-out pot are available for analysis.

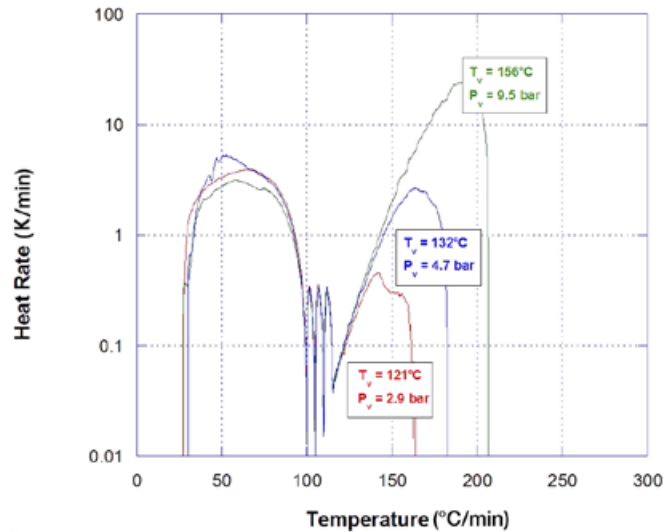

Vented tests showing increasing tempering as the vent set pressure is reduced

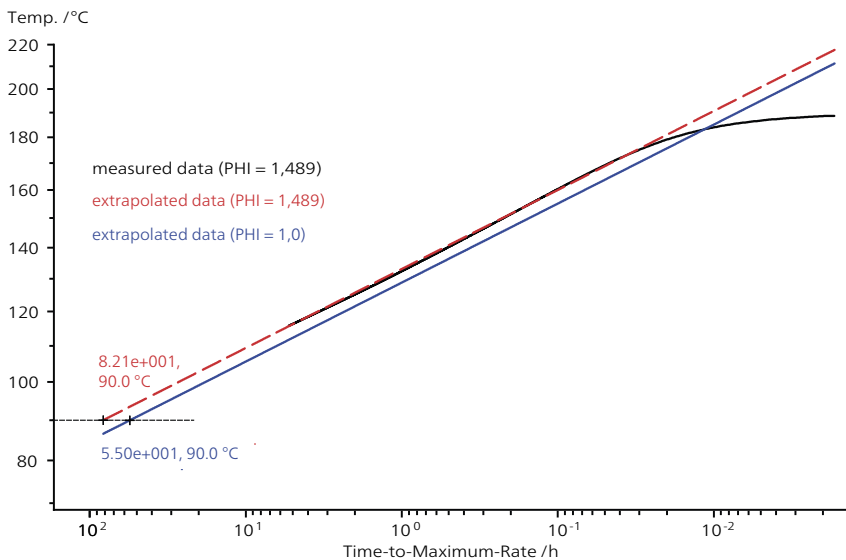

Temperature plotted versus Time-to-Maximum-Rate (logarithmic scaling) for a measurement performed with 5.74 g of DTBP in toluene in a titanium sample vessel (Phi factor 1.489)

If the substance/mixture is stored in a vessel which exhibits heat loss in the order of $\Phi = 1.489$, then the maximum self-heating rate will be reached after 82 hours. However, if there is no heat loss during storage ($\Phi = 1$), the maximum self-heating rate will be already achieved after 55 hours.

Time-to-Maximum-Rate (TMR)

In order to identify potential hazards of chemicals during processing and storage often the Time-to-Maximum-Rate (TMR) is measured under adiabatic conditions. This information is used for predicting the temperatures for safe storage of chemicals. TMR is the time between the start of a thermal runaway reaction and the maximum reaction rate (maximum self-heating rate). In case a chemical reactor faces the hazardous event of a runaway reaction, the maximum reaction rate is equivalent to an explosion. As the experimentally observed TMR value using the ARC is influenced by the Phi factor of the reaction vessel usually a correction to $\Phi = 1$ is done which in fact predicts the worst case scenario.

Typical Battery Applications

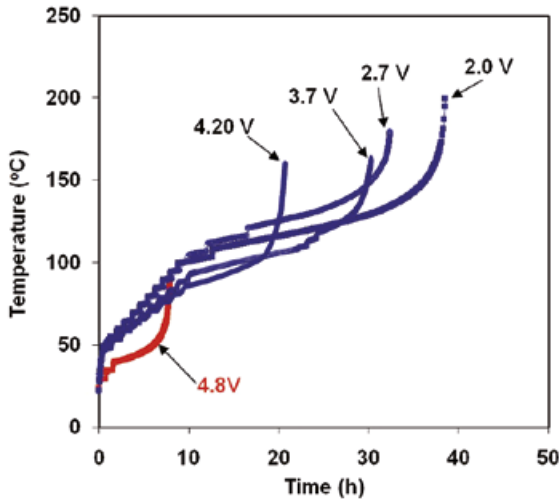

Effect of state-of-charge on the thermal stability of a prototype 18650 lithium ion batteries

Battery Thermal Runaway

Adiabatic calorimeters allow the researcher to test full cells in an adiabatic environment to determine how well they perform in real and exaggerated conditions. Cells can be charged and discharged while inside the calorimeter so many use scenarios can be tested. With the *VariPhi*[®] option, cells can be held isothermally during the charge and discharge process in order to get important data on heat energy management.



Lithium-ion battery

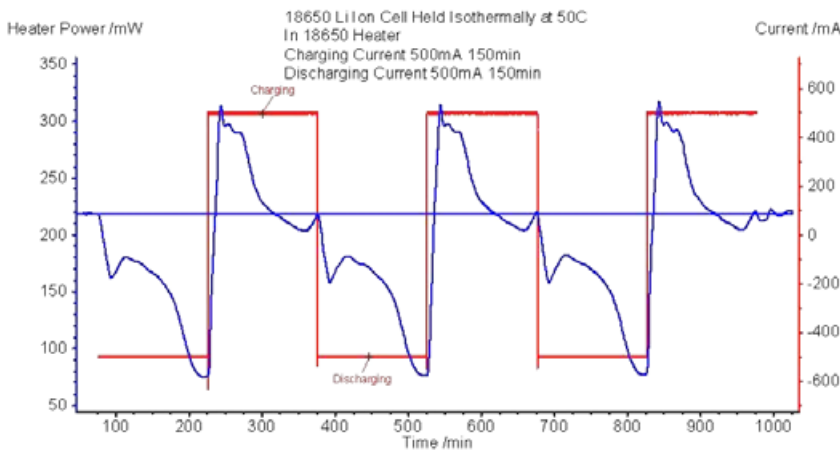

Cell heater power and cell current versus time for an isothermal battery cycling test on ARC[®] 254

Battery Cycling – isothermal

Battery cycling inside a calorimeter can provide insight into the underlying phenomena occurring in the cell. Furthermore, the necessary data to design thermal management systems for battery packs can be determined at normal and exaggerated operating conditions.

VariPhi® Heaters for Various Battery Sizes



18650 cell and its VariPhi® 3-D sensor



D cell and its VariPhi® 3-D sensor

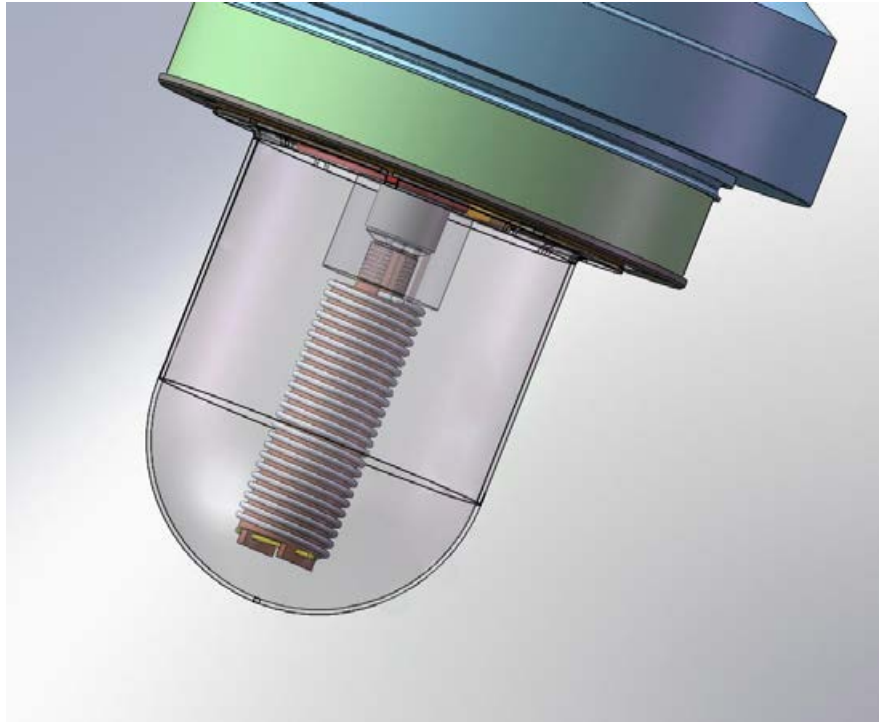

Expertise in SERVICE

All over the world, the name NETZSCH stands for comprehensive support and expert, reliable service, both before and after sale. Our qualified personnel from the technical service and application departments are always available for consultation. In special training programs tailored for you and your employees, you will learn to tap the full potential of your instrument.

To maintain and protect your investment, you will be accompanied by our experienced service team over the entire life span of your instrument.

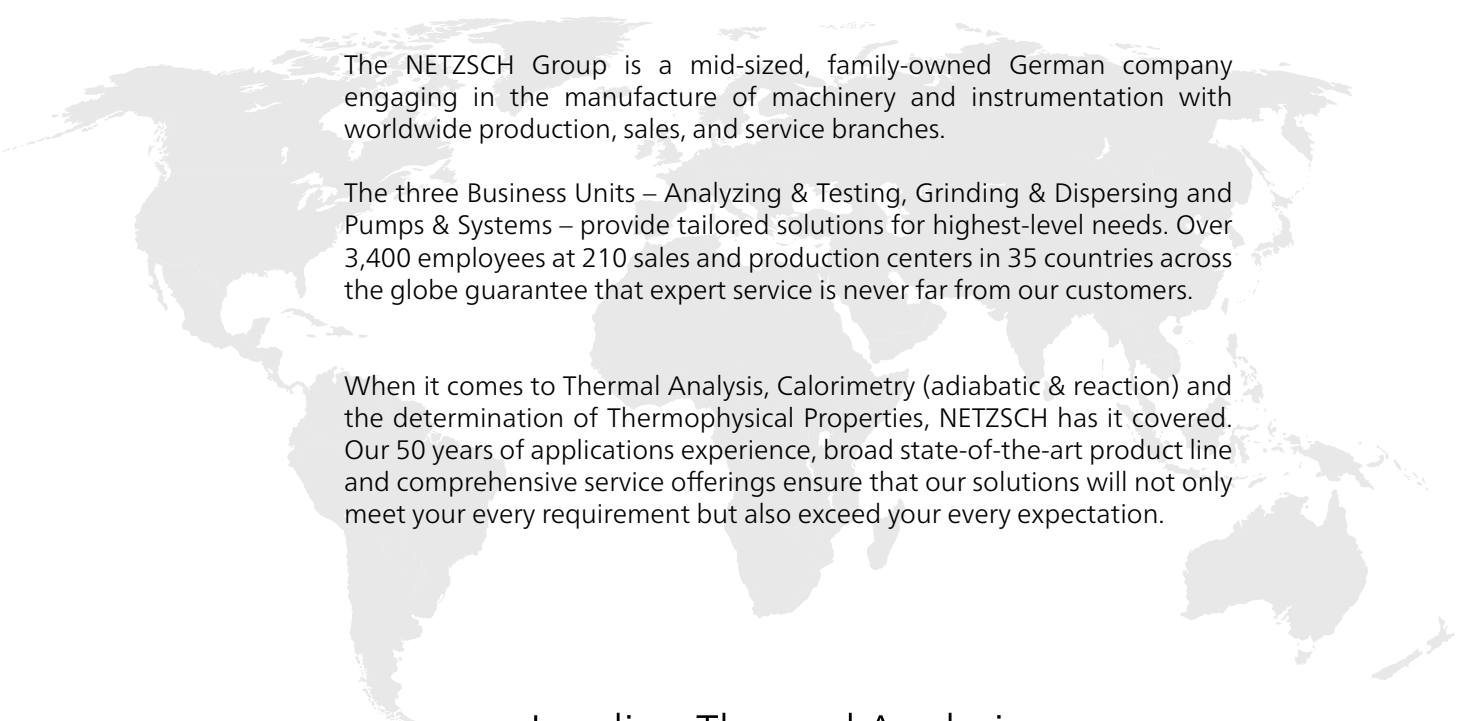

The NETZSCH Group is a mid-sized, family-owned German company engaging in the manufacture of machinery and instrumentation with worldwide production, sales, and service branches.

The three Business Units – Analyzing & Testing, Grinding & Dispersing and Pumps & Systems – provide tailored solutions for highest-level needs. Over 3,400 employees at 210 sales and production centers in 35 countries across the globe guarantee that expert service is never far from our customers.

When it comes to Thermal Analysis, Calorimetry (adiabatic & reaction) and the determination of Thermophysical Properties, NETZSCH has it covered. Our 50 years of applications experience, broad state-of-the-art product line and comprehensive service offerings ensure that our solutions will not only meet your every requirement but also exceed your every expectation.

Leading Thermal Analysis ■

NETZSCH-Gerätebau GmbH
Wittelsbacherstraße 42
95100 Selb
Germany
Tel.: +49 9287 881-0
Fax: +49 9287 881 505
at@netsch.com

NETZSCH[®]

www.netsch.com