



Sciospec ISX-3v2 – Electrical Impedance Spectroscopy

Measurement Parameters

impedance	absolute value of impedance, phase of impedance in degree, phase of impedance in radiant, resistance, reactance, absolute value of admittance, phase of admittance in degree, phase of admittance in radiant, conductance, susceptance
-----------	--

Measurement Terminal

configuration	four wire configuration, three wire configuration, two wire configuration (counter <i>C</i> , reference <i>R</i> , work <i>W</i> , working Sense <i>WS</i>)
connector type	four BNC (female, standard polarity) connectors, Sciospec <i>ExtensionPort</i>

Sciospec ExtensionPort

connector type	Samtec FCS8 20 Pin
signal level standard	LVC MOS 3V
maximum input voltage ¹	3.6V
minimum input voltage	-0.3V
high level input voltage	≥1.7V
low level input voltage	0.8V
high level output voltage	≥2.8V
maximum output current	12mA
ESD protection of IOs	±12kV IEC 61000-4-2 contact ESD ±15kV IEC 61000-4-2 air-gap ESD clamp voltage 10.5V (min) break-down voltage 7V (min)
number of IOs	eight total (freely distributable between input and output)
IO configuration	GPIO, UART, I ² C
measurement terminals	four (counter <i>C</i> , reference <i>R</i> , work <i>W</i> , working sense <i>WS</i>)
power terminals	±5V; 500mA for each voltage
pin assignment	see Tab 1, shielding GND
connector Layout	see Fig 1

PIN	1	2	3	4	5	6	7	8	9	10	11	12	13	14	15	16	17	18	19	20
Mode																				
GPIO	W	+5V	+5V	+5V	+5V	WS	IO1	IO2	IO3	IO4	IO5	IO6	IO7	IO8	R	-5V	-5V	-5V	-5V	C
I ² C	W	+5V	+5V	+5V	+5V	WS	SCK1	SDA1	SCK2	SDA2	d.n.c.	d.n.c.	d.n.c.	d.n.c.	R	-5V	-5V	-5V	-5V	C
UART	W	+5V	+5V	+5V	+5V	WS	Rx	Tx	d.n.c.	d.n.c.	d.n.c.	d.n.c.	d.n.c.	d.n.c.	R	-5V	-5V	-5V	-5V	C

Tab 1: ExtensionPort pin assignment for different modes of operation

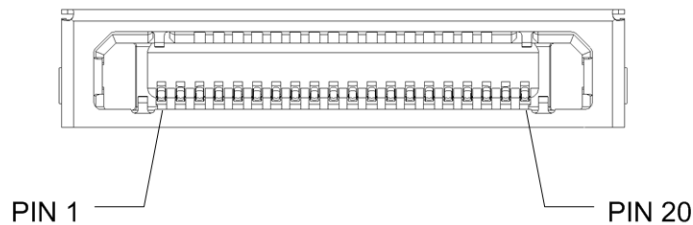

Fig 1: ExtensionPort Pin Assignment

Frequency

range	100mHz to 10MHz
resolution	10mHz (depending on frequency range setting)
precision absolute	±100ppm (at 25°C)
temperature drift	±10ppm over operating temperature range
long time stability	±5ppm first year

Voltage Signal

range	1mV to 1000mV peak-amplitude
resolution	0.1 mV

Output Impedance

output impedance	300Ω (nominal)
------------------	----------------

DC Bias

voltage range	0V to 8V (see Fig 7)
voltage resolution	10 mV
current range	0A to 20mA (see Fig 7)
current resolution	25μA

Precision settings

precision range	0 to 1 high speed, lower accuracy 1 standard configuration $\Delta Z / Z < 0.1\%$ 1 to 10 high accuracy, low speed see Fig 5 and Fig 6
averaging	1 to 1024

Sweep Settings

available sweep parameters	frequency, amplitude, DC bias voltage, DC bias current, kinetic, point delay
sweep type	linear, logarithmic, list
points	1 to 2048
sweep delay ⁱⁱ	0s to 3min in 1 μ s steps
point delay ⁱⁱⁱ	0s to 3min in 1 μ s steps

Synchronisation Ports (*SyncPort*)

sync ports	two inputs, two outputs,
sync input type	point hold off, sweep hold off, immediate stop
sync output type	sweep complete, point complete
connectors	four SMA (female, standard polarity)
ESD protection	\pm 12kV IEC 61000-4-2 contact ESD \pm 15kV IEC 61000-4-2 air-gap ESD clamp voltage 10.5V (min) break-down voltage 7V (min)
absolute maximum input voltage ⁱ	5.5V
absolute minimum input voltage	-0.3V
high level input voltage	\geq 2V
low level input voltage	\leq 0.8V
high level output voltage	\geq 2.7V (open drain buffer with 1kOhm pull up resistor to 3V)
low level output voltage	\leq 0.55V
maximum output current	24mA
typical input capacitance	3pF

IO Port (optional)

connector type	D-Sub-Mikro-D 20Pin
signal level standard	LVC MOS 3V
absolute maximum input voltage ⁱ	3.6V
absolute minimum input voltage	-0.3V
high level input voltage	\geq 1.7V
low level input voltage	\leq 0.8V
high level output voltage	\geq 2.8V
low level output voltage	\leq 0.2V
maximum output current	12mA
ESD Protection of IOs	\pm 12kV IEC 61000-4-2 contact ESD \pm 15kV IEC 61000-4-2 air-gap ESD clamp voltage 10.5V (min) break-down voltage 7V (min)
number of IOs	eight (freely distributable between input and output)

IO configuration	GPIO, UART, I ² C
UART configuration	115.2kBaud, 1 start bit, 8 data bits, 1 stop bit, even polarity, idle high
I ² C configuration	100kbit, 7bit address, standard mode, device behaves as master
number of temperature sensors	2
temperature sensor type	Negative temperature coefficient (NTC) configurable: Reference resistance, reference temperature, Beta value
pin assignment	See Tab 2
connector layout	See Fig 2

PIN	1	2	3	4	5	6	7	8	9	10	11	12	13	14	15	16	17	18	19	20
GPIO	GND	NTC1	GND	NTC2	GND	IO1	GND	IO2	GND	IO3	GND	IO4	GND	IO5	GND	IO6	GND	IO7	GND	IO8
I ² C	GND	NTC1	GND	NTC2	GND	SCK1	GND	SDA1	GND	SCK2	GND	SDA2	GND	d.n.c.	GND	d.n.c.	GND	d.n.c.	GND	d.n.c.
UART	GND	NTC1	GND	NTC2	GND	Rx	GND	Tx	GND	d.n.c.	GND	d.n.c.	GND	d.n.c.	GND	d.n.c.	GND	d.n.c.	GND	d.n.c.

Tab 2: IO Port pin assignment for different modes of operation

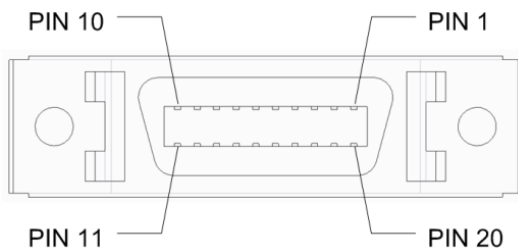

Fig 2: IO Port connector

LAN Interface

standard conformity	10/100 Base-T, RJ45
protocol	TCP/IP

USB Interface

standard conformity	USB 2.0 Type B
protocol	High Speed USB

General Specifications

power requirements	100-240V AC (typ.), 50/60Hz, 15W (max)
dimensions	248.67mm x 97.1mm x 193.2mm (width x height x depth) see Fig 3 and Fig 4
weight	2.5kg (typical)
operating conditions	0°C to 40°C, <80% relative humidity non condensing, 0...3000m altitude
non-operating conditions	-25°C to 80°C, <80% relative humidity non condensing ¹

¹ The temperature gradient should not exceed 1K/min to reach operating conditions.

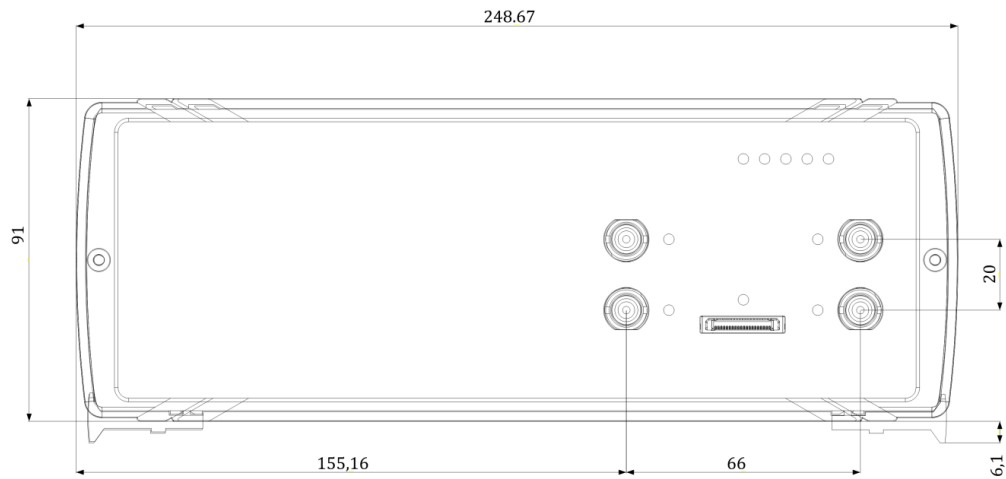

Fig 3: ISX-3v2 front view



Fig 4: ISX-3v2 side view

Specifications

All specifications above are stated for operation at temperatures between 0°C and 40°C. Warm-up time must be greater than or equal to 30 minutes after power on for all specifications.

Electro static discharge Warning



This product, like all electronic products, uses semiconductors that can be damaged by electrostatic discharge (ESD). When handling, care must be taken so that the devices are not damaged. Damage due to inappropriate handling is not covered by the warranty.

Relation between the precision setting and the measurement time and measurement accuracy

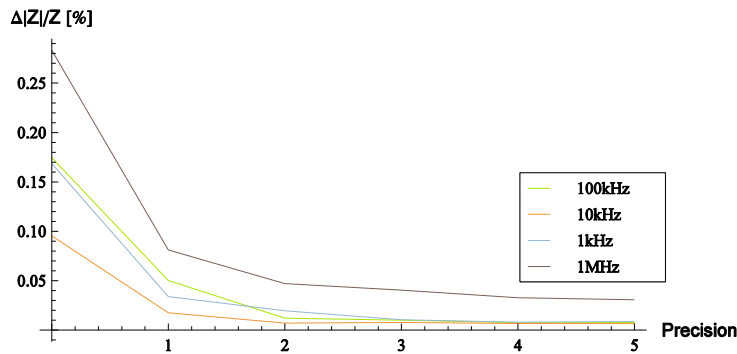

Fig 5: Accuracy over Precision Parameter

The diagram on the left shows the influence of the precision settings on the accuracy and time for the measurement of an impedance value at the specified frequency.

Low precision settings correspond to fast measurements with lower accuracy. High precision settings correspond to greater accuracy at longer measurement times.

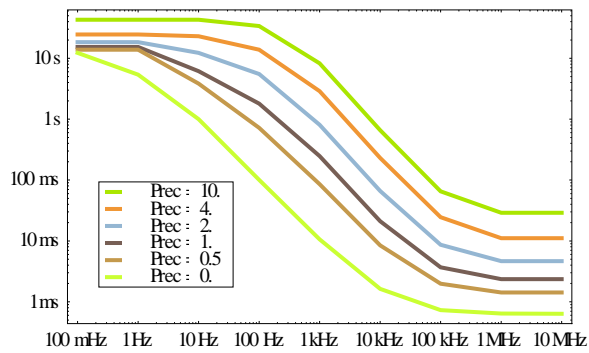

Fig 6: Measurement Time over Precision Parameter

DC Bias Ranges

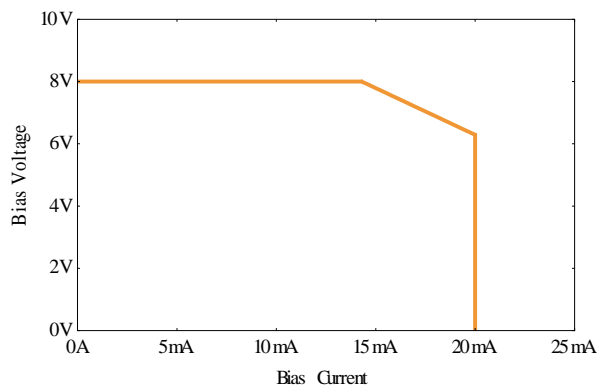
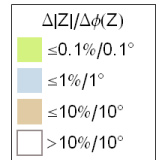
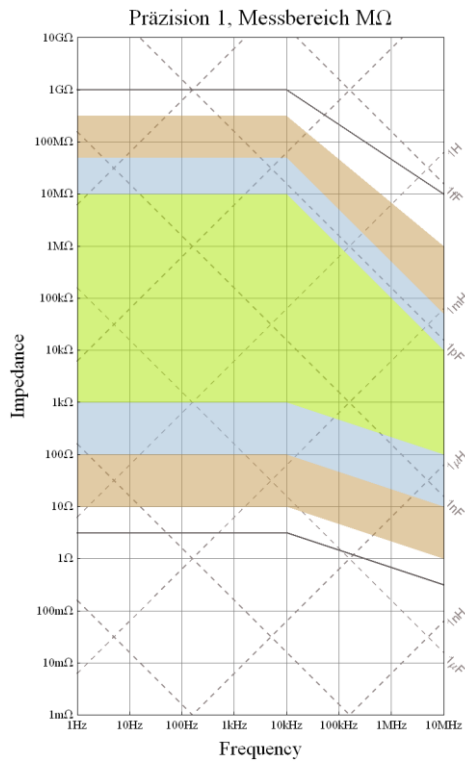
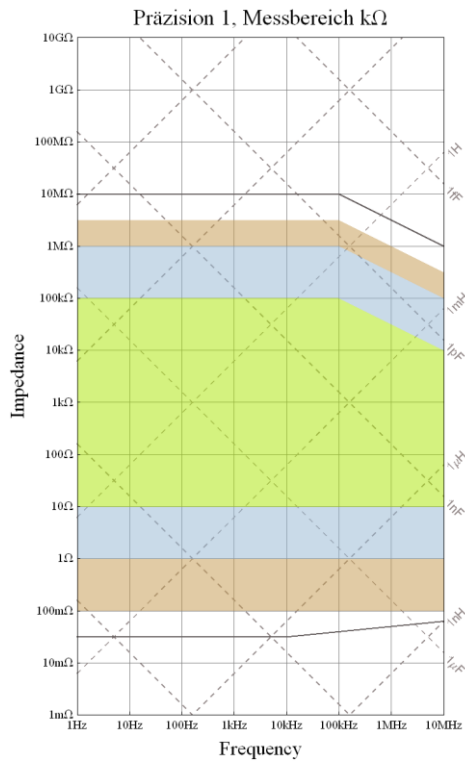
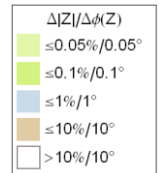
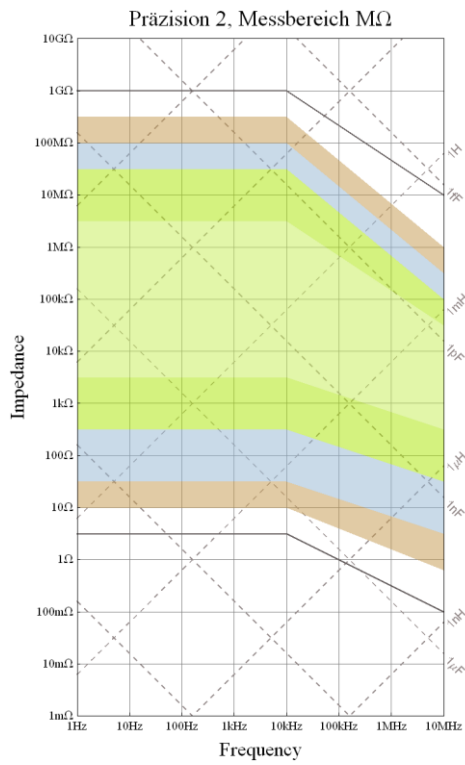
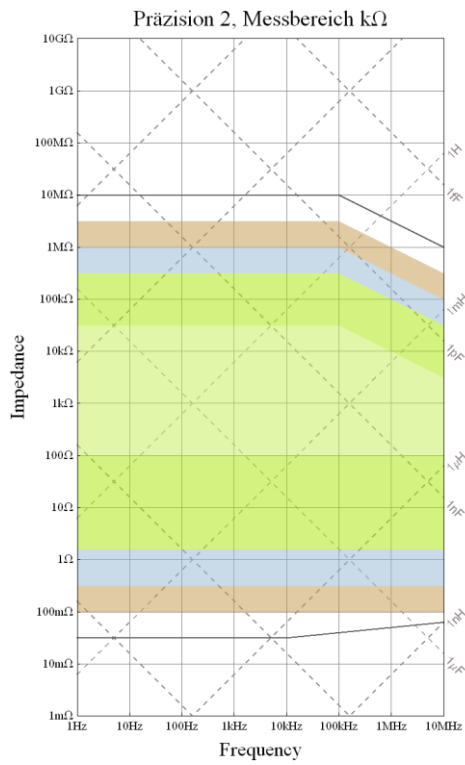

Fig 7: DC Bias Range

Overview of the different range and precision settings



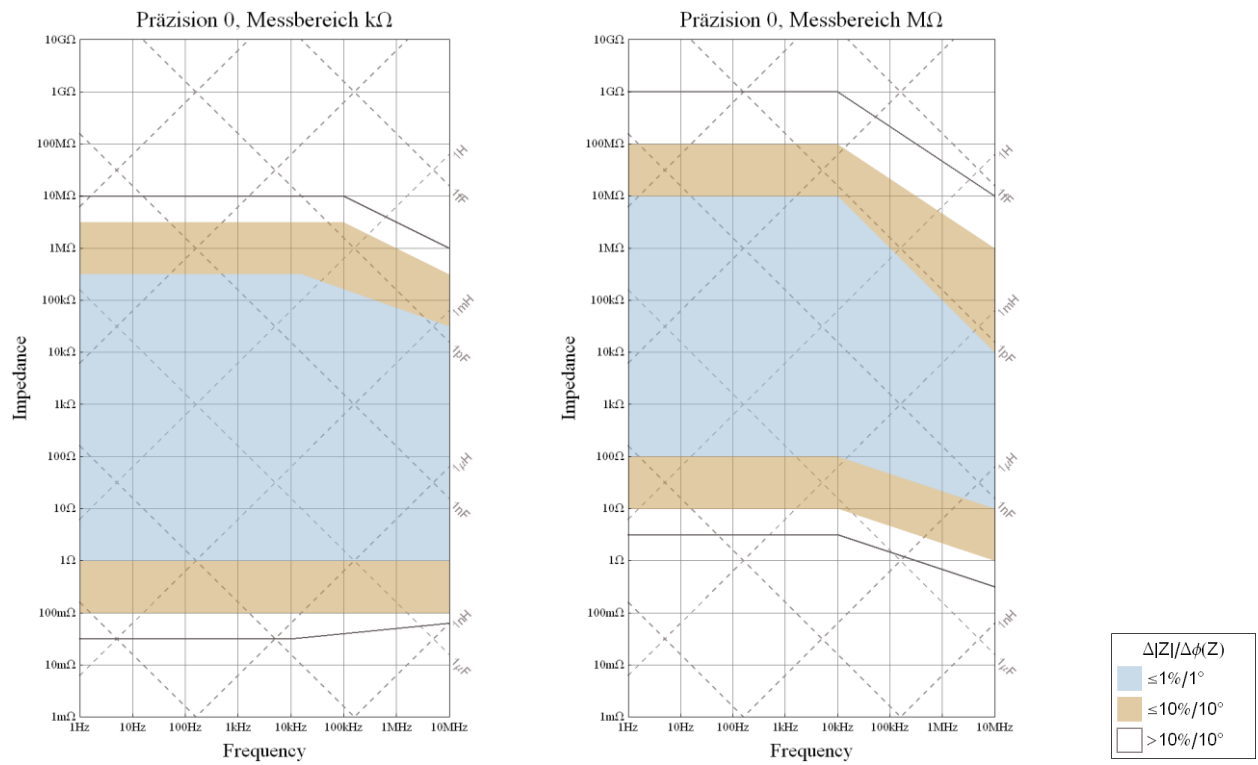

Fig 8: Precision-Range Plot

All specifications refer to measurements done with a Sciospec ISX-3v2 in combination with the Sciospec MEArack. The signal amplitude is set to 100mV and the frequency range to „<10MHz“. Measurements done, using the BNC connectors show very similar results.

Example measurement:

Frequency sweep: 100Hz – 1MHz, 80 logarithmic Frequency steps, precision 1, amplitude 100mV, measurement range $M\Omega$

Measurement instrument: Sciospec ISX-3v2 with connected Sciospec MEArack

DUT: Multielectrode array, 40 μm electrodes, 200 μm apart, platinum PBS buffersolution

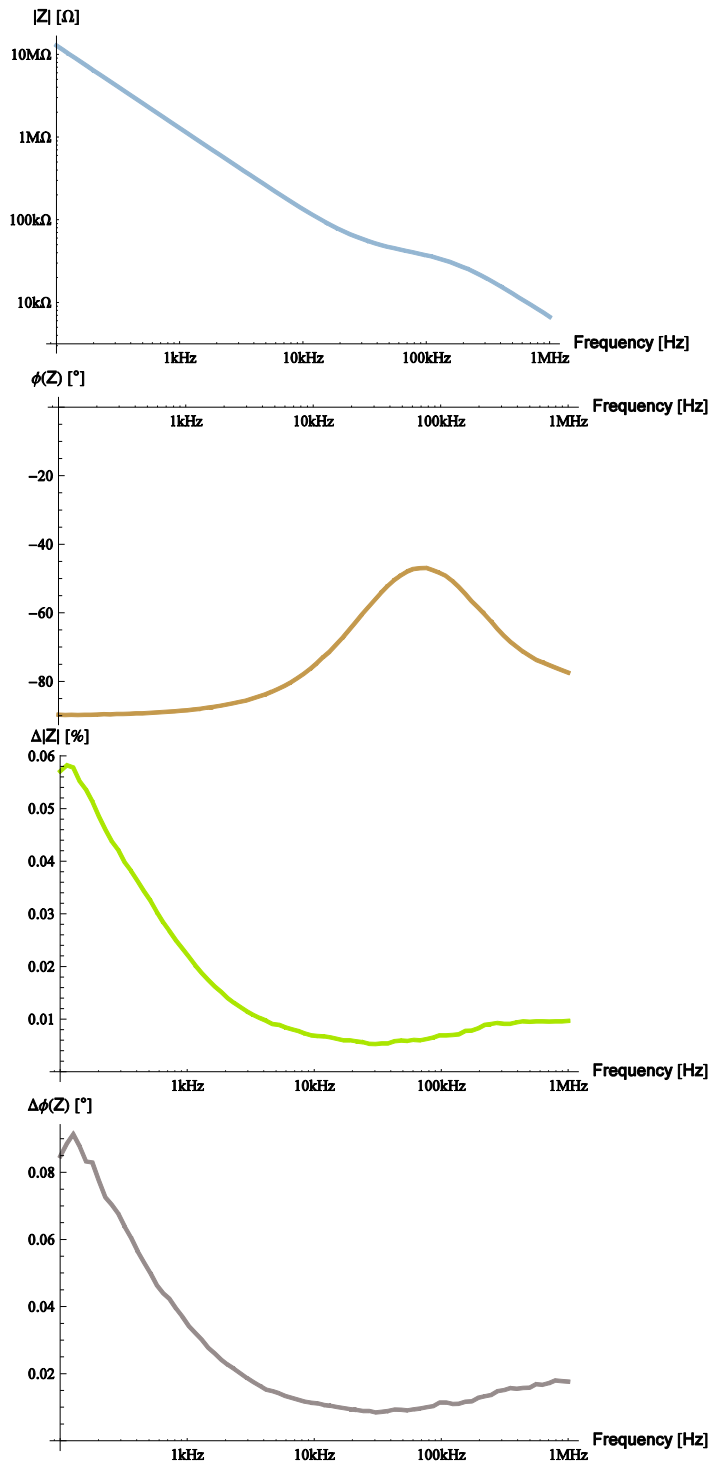

ⁱ Inputs are internally biased to 3V by a 1M Ω pull up resistor.

ⁱⁱ Sweep-Delay...Timing delay between two consecutive measurements of complete impedance spectra

ⁱⁱⁱ Point-Delay...Timing delay between two consecutive measurements of single frequencies