

NETZSCH



Thermal Analysis Mass Spectrometer Coupling

Evolved Gas Analysis
Method, Techniques and Applications

Leading Thermal Analysis ■

Thermal Analysis and Evolved Gas Analysis

Thermoanalytical Techniques

Thermoanalytical techniques are universal tools for characterizing solids and liquids with respect to their thermal behavior. Especially Thermogravimetry and Simultaneous Thermal Analysis (STA, TGA-DTA/DSC) find broad application in testing the weight changes of a sample during a programmed heat treatment. This yields a multitude of information on material properties, composition and stability.

However, chemical and analytical information about the products causing the weight changes to the sample is often lacking. Evolved Gas Analysis (EGA) by such techniques as quadrupole mass spectrometry can supply this additional information.

Application Fields for Thermal Analysis Coupled to Mass Spectrometry

Decomposition

- Dehydration
- Stability
- Residual solvent
- Pyrolysis

Solid-Gas Reactions

- Combustion
- Oxidation
- Adsorption
- Desorption
- Catalysis

Compositional Analysis

- Polymer content
- Proximate analysis
- Binder burnout
- Dewaxing
- Ash content

Identification

- Gas composition
- Fingerprint
- Partial pressure
- Fragmentation
- Solid-gas interactions

Evaporation

- Vapor pressure
- Sublimation



QMS 403 D Aëolos®

Reasons to Couple a Thermal Analyzer to a Mass Spectrometer

Complementary Information

Mass changes detected by thermal analysis can be explained by gas analysis in the mass spectrometer; a workstation for analytical chemistry is thus formed. Evolved species are detected down to the ppm level, which exceeds the standard sensitivity of thermal analysis methods. The coupling of thermal analysis with mass spectrometry therefore results in high-class material research and characterization.

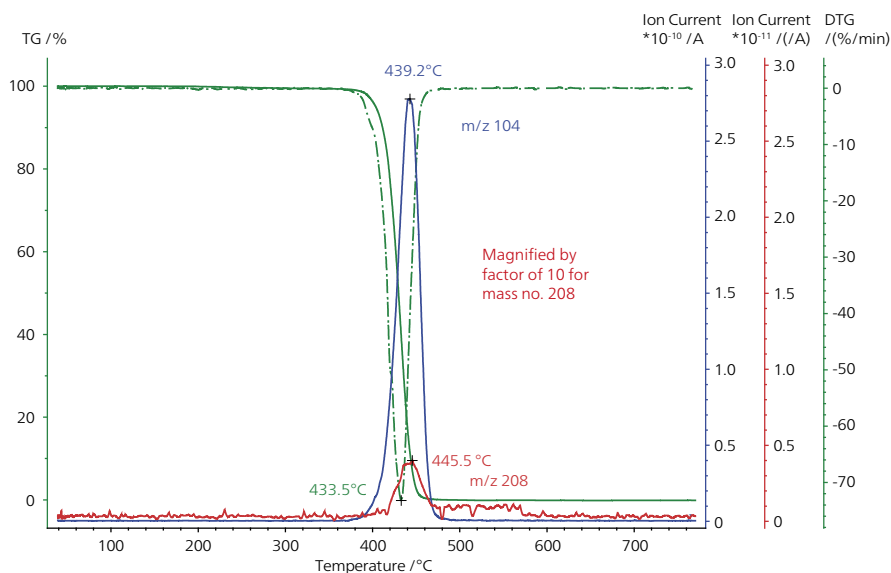

Quadrupole Mass Spectrometry (QMS)

The sensitive, selective, fast and continuous functionality of a quadrupole mass spectrometer makes this system ideally suited for evolved gas analysis in combination with thermal analyzers, specifically Thermogravimetry (TGA) and Simultaneous Thermal Analysis (STA, TGA-DTA/DSC).

Optimum coupling with thermal analyzers is provided thanks to the small dimensions of the quadrupole mass filter, the efficient and reproducible ionization of gases in the electron impact ion source, and the resolution in the detection of molecules, atoms and fragments.

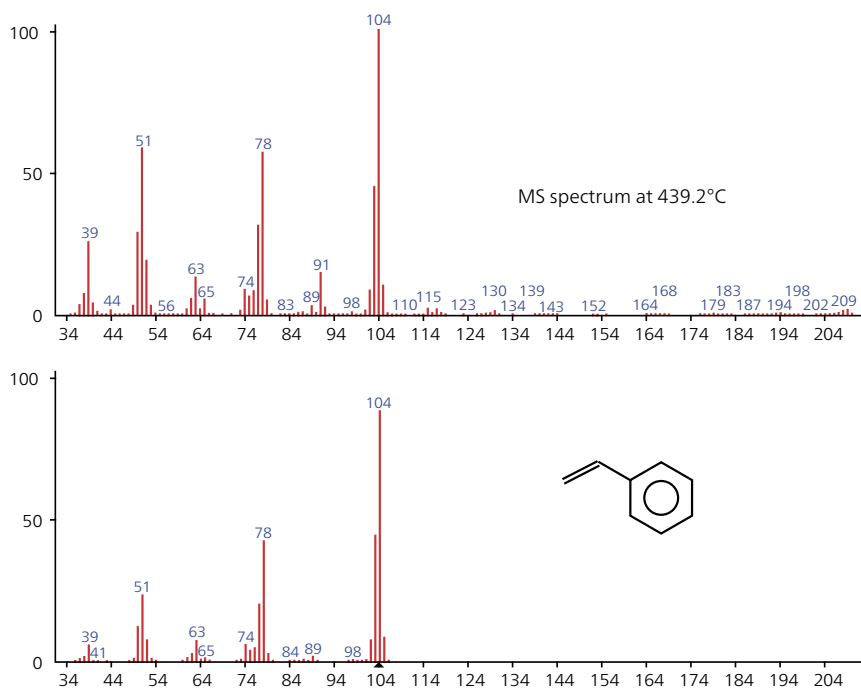

Upper plot: TGA-QMS *Aëolos*[®] measurement on an unknown polymer shows one mass-loss step between 400°C and 460°C.

Lower plot: NIST library search of the spectrum measured at 22.4 min clearly indicates styrene. Also the dimer of styrene is detected, see mass number 208 in the upper plot.

HYPHENATION OF THERMAL ANALYSIS AND EVOLVED GAS ANALYSIS



STA 449 **F1** Jupiter® coupled to QMS 403 D Aëolos®;
other thermal analyzers can also be coupled to MS, such as the TG 209 **F1** Libra®

Withstanding the Test of Time – Capillary and *SKIMMER* Coupling Techniques

NETZSCH offers complete solutions for Thermal Analysis coupled to Mass Spectrometry in terms of both hardware and software. Evaluation and presentation of the results is carried out with the well-proven *Proteus*® software.

Gas flow conditions in all thermal analyzers are ideal for coupling to a mass spectrometer via capillary or a double-orifice system known as the *SKIMMER* coupling.

By measuring the mass numbers (m/z), conclusions on the composition of the evolved gases can be drawn.

While the capillary coupling is well-suited for the investigation of permanent gases, the *SKIMMER* coupling is advantageous for metallic ions and inorganics where condensation can be expected at higher temperature.



STA 409 CD *SKIMMER*



TA-QMS Coupling Techniques

Interface for Pressure Adjustment

Mass spectrometers, composed of a mass filter, an electron impact ion source and an ion detector, work only in high vacuum. Therefore, an interface is required for the coupling of a thermobalance – which works with a purge gas flow at atmospheric pressure – to the mass spectrometer. Different versions of pressure reduction interfaces are realized, depending on instrumentation and applications.

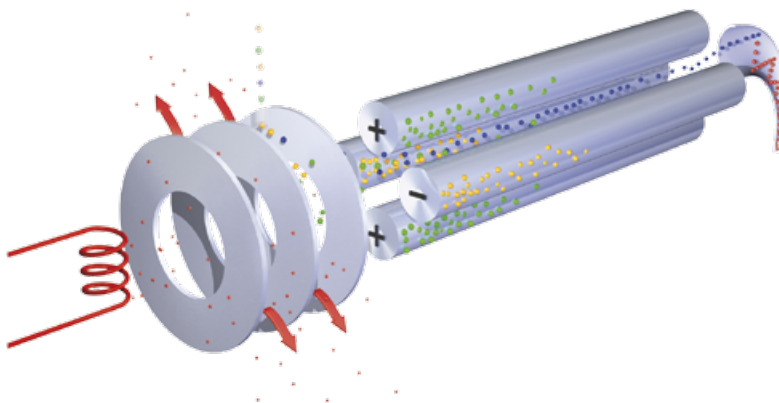

QMS 403 D Aëolos®

Single-Step Pressure Reduction

A capillary of small internal diameter connects the gas outlet on the furnace of the thermobalance with the gas inlet on the mass spectrometer. The pressure drops from atmospheric pressure down to high vacuum in one continuous step.

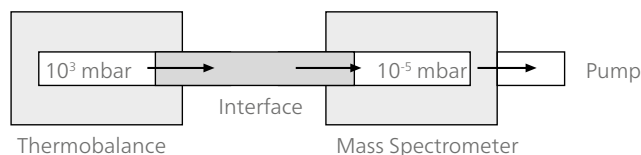

Capillary Coupling

STA 409 CD SKIMMER

Double-Step Pressure Reduction

Different systems such as laminar flow capillary, nozzle, and orifice are used to reduce the pressure in the first step down to the range from 10^{-1} mbar to 10 mbar. A membrane pump, rotary pump or the drag stage of the turbo molecular pump is applied to achieve this pressure reduction. The second step is either an orifice or a skimmer as a molecular leak for the gas inlet into the high-vacuum recipient of the mass spectrometer.

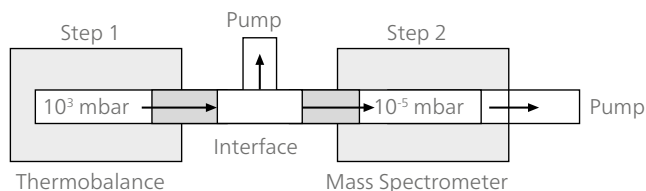

Double orifice SKIMMER coupling

Ideal Gas Flow Conditions Ensure Transport of All Relevant Gases

The aim of coupling is to have all relevant gases and vapors transported from the sample area into the ion source of the mass spectrometer for precise qualitative and quantitative analysis. This is only achieved through perfect gas flow conditions in the thermal analyzer, the coupling interface and the gas inlet of the mass spectrometer. As only a small quantity of gas is required for the analysis, a bypass is used at the gas outlet on the thermobalance for the excess purge gas flow; i.e., for the flow not passing through the coupling interface, which can be used for a second gas analyzer such as FT-IR.

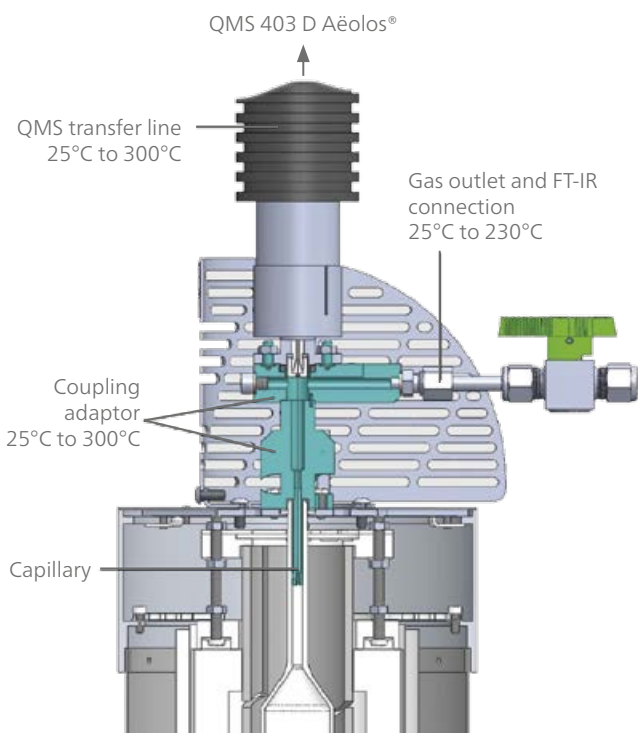

Capillary coupling

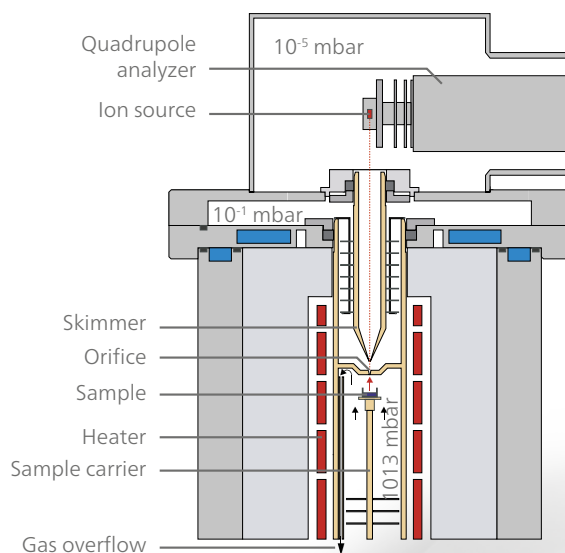

Double orifice SKIMMER coupling

Perfectly coupled for precise results.

Coupling TA-QMS 403 D *Aëolos*®

A fleshed-out design for capillary coupling to NETZSCH thermal analyzers (e.g., simultaneous TGA-DSC, STA) can be found in the QMS 403 D *Aëolos*® quadrupole mass spectrometer. Volatile sample materials under a controlled temperature treatment are directly transferred into the electron impact ion source of the MS via a fused silica capillary.

TOP-LINE
CAPILLARY
COUPLING

Overall Heating
and Single-Step
Pressure Reduction

The Capillary Coupling is Designed for Optimum Gas Flow Conditions and Flexibility

- Minimization of cold spots in the transfer path
- Minimized condensation losses due to overall temperature of 300°C across the entire gas transfer system from the furnace outlet to the capillary to the MS gas inlet.
- Flexible, allowing standard thermoanalytical measurements and also simultaneous TGA, MS (GC-MS) and MS-FT-IR measurements.
- Very robust and service-friendly while still maintaining high sensitivity (detectable mass loss in the µg-range).
- Allows TGA-MS measurements under humid atmospheres.
- Upgrade of existing thermal analyzers.

The QMS 403 D *Aëolos*® can also be independently employed for the analysis of other gas sources.

TGA-DSC/DTA Systems

STA 449 **F1** *Jupiter*®

- T-range: -150°C to 2000°C
- Weighing range: 5 g
- TGA resolution: 0.025 µg

STA 449 **F3** *Jupiter*®

- T-range: -150°C to 2400°C
- Weighing range: 35 g
- TGA resolution: 0.1 µg

STA 449 **F5** *Jupiter*®

- T-range: RT to 1600°C
- Weighing range: 35 g
- TGA resolution: 0.1 µg

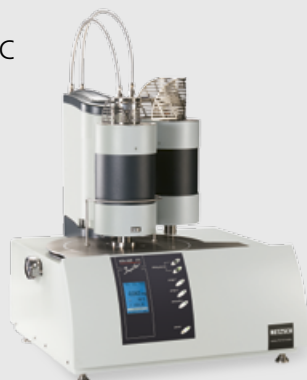

TGA Systems

TG 209 **F1** *Libra*®

- T-range: RT to 1100°C
- Weighing range: 2 g
- TGA resolution: 0.1 µg

Automatic sample changer for up to 192 sample pans





Natural vertical gas flow through the STA furnace to the heated adapter with capillary inlet and bypass



Insulated inert quartz glass capillary with controlled heating to 300°C for lossfree gas transfer to the QMS

Heated chamber for easy handling and precise adjustment of the capillary inlet to the QMS

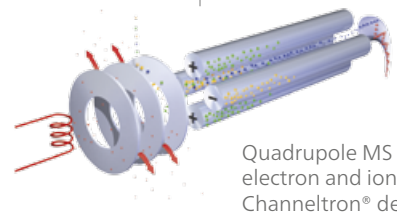

Quadrupole MS with cathode, electron and ion lenses, mass filter and Channeltron® detector

DSC/DTA Systems

DSC 404 **F1/F3** Pegasus®

- T-range: -150°C to 2000°C
- High-sensitivity and high-resolution sensors



Dilatometer/Thermomechanical Analyzer

DIL 402 **Supreme**

- T-range: -180°C to 2000°C
- Measuring range: 5000 µm
- Δl resolution: 0.1 nm

DIL 402 **Select**

- T-range: -180°C to 1600°C
- Measuring range: 2000 µm
- Δl resolution: 1 nm



TMA 402 **F1/F3** Hyperion®

- T-range: -150°C to 1550°C
- Measuring range: 500 µm/5000 µm
- Δl resolution: 0.125 nm/1.25 nm

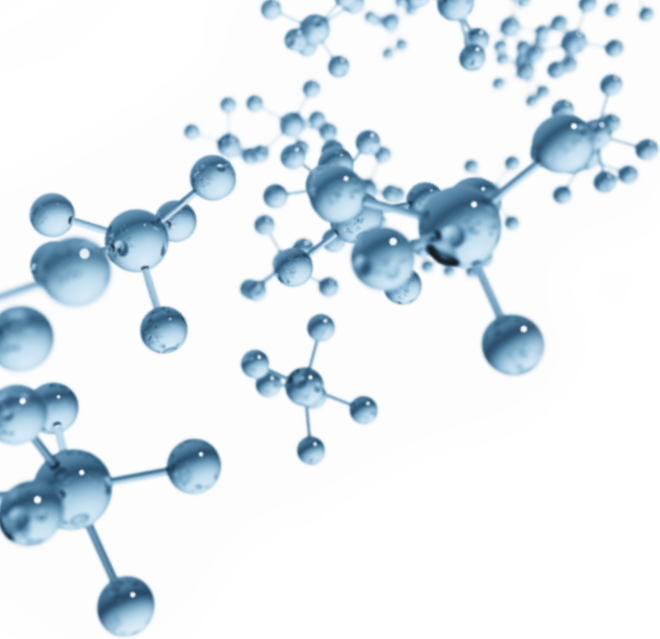

Continuous heating of the entire gas transfer line reduces the risk of condensation so that even larger molecules can be detected.

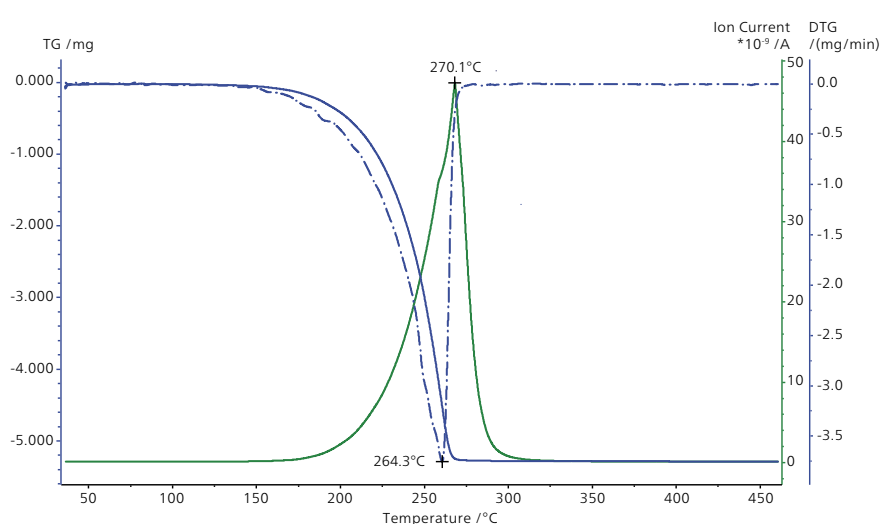

Optimized Transfer Path Allows for the Detection of Larger Molecules – Heptadecane Detection

This measurement was carried out with the STA 449 **F3 Jupiter**[®] coupled to the QMS **Aëolos**[®]. The temperature adapter, transfer line and MS inlet were set to 300°C.

Evaporation of this unbranched isomer ($\text{CH}_3(\text{CH}_2)_{15}\text{CH}_3$; bp. 302°C) starts at approx. 170°C (blue curve). The maximum decomposition rate is achieved at 264,3°C (DTG peak, dotted line) when using a heating rate of 20 K/min. After a short delay (0.4 min), the ion current achieves its maximum at 270,1°C (dark blue curve). After detection of heptadecane in the MS, the ion current immediately returns to the zero-level without any tailing effect.

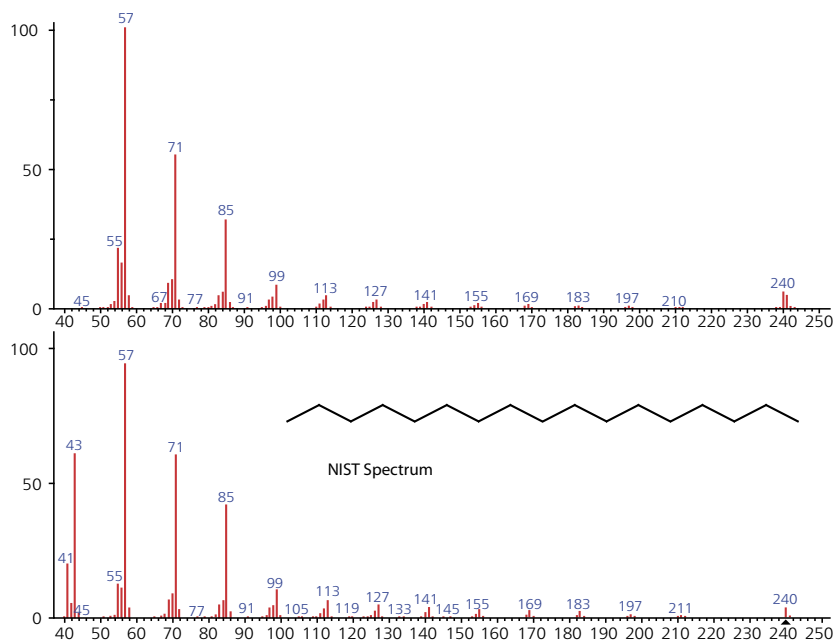

A comparison between the detected MS spectrum for heptadecane and the corresponding NIST library spectrum confirms that even larger molecules (e.g., m/z 240) pass the adapter, transfer line and MS inlet without condensation.

ACCESSORIES MAKE THE DIFFERENCE

Water-Vapor Furnace up to High Water-Vapor Concentrations

STA-MS Measurements under Water-Vapor Atmosphere

In addition to a variety of other furnaces for the STA systems, NETZSCH also offers a water-vapor furnace which allows for pure vapor atmospheres at the sample between room temperature and 1250°C. The water-vapor furnace can be connected with a humidity or a water-vapor generator. It provides protection against flooding and minimal dilution due to a special gas flow design.

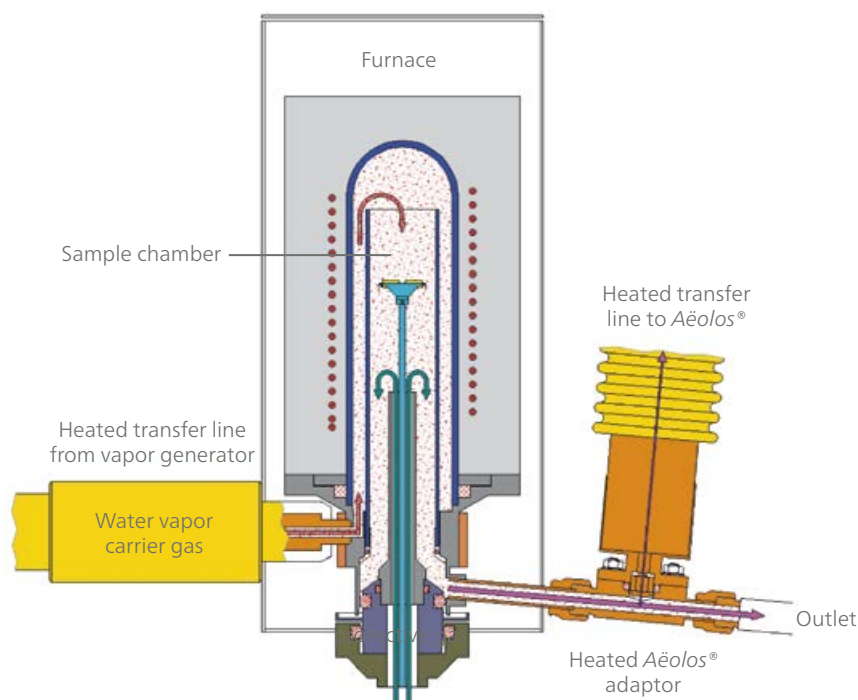

Monitoring Reaction Steps During the Carbon Gasification Process

This plot shows a typical example of the configuration with the water-vapor furnace: Here, the water vapor – present in relatively high concentrations (20% H₂O) – serves as a reactant for the transition from coal to hydrogen, and the STA with coupled gas analysis shows both the weight loss of the coal sample and the products resulting from the reaction.

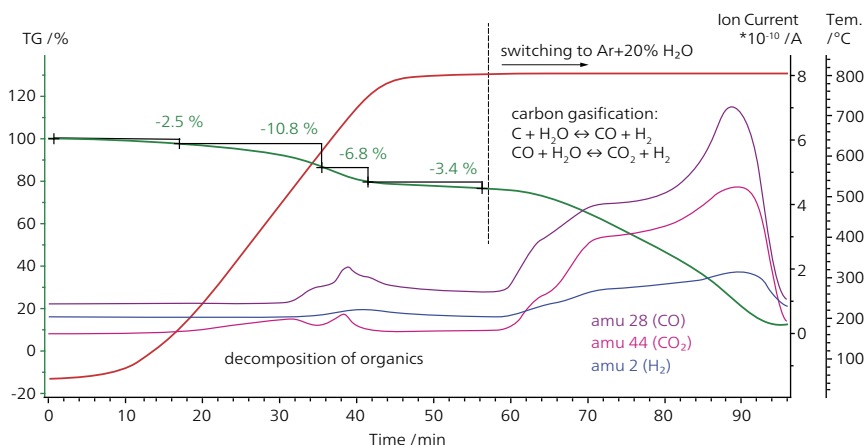

TA-QMS 403 D Aëolos® Application

Measurement of an Unknown Polymer

This TGA-MS measurement of an unknown polymer (7.52 mg) was carried out in the temperature range between room temperature and 250°C in a helium atmosphere. The 3-D plot above shows the TGA measurement together with the MS results. The plot on the right correlates the TGA curve with various MS traces of m/z 35, 47, 48, 51, 77, 83, and 105.

By exporting the 2-dimensional scan-bargraph directly into the NIST database (see image below as an example at 166°C), it becomes possible to interpret the individual mass-loss steps.

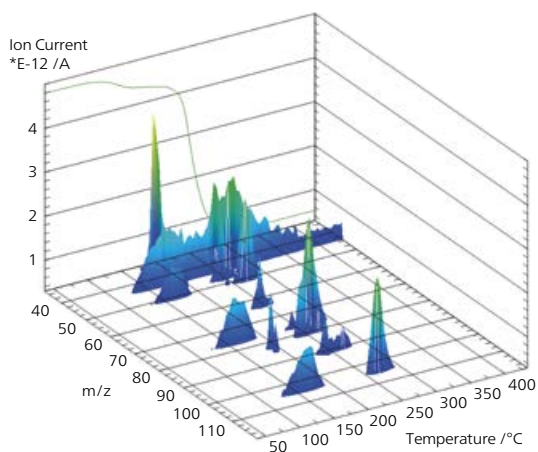

3-D plot of a TGA-MS measurement on an unknown polymer sample as a function of temperature

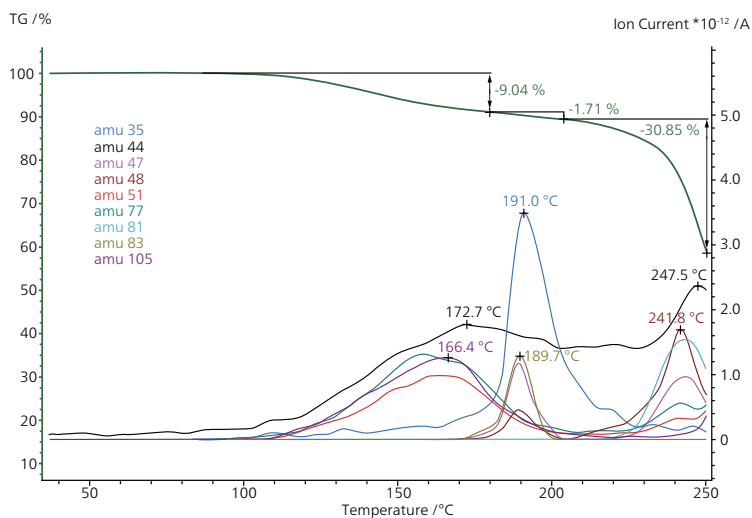

Correlation of mass-loss steps and different gases detected and identified in the MS; 35 amu most probably corresponds to HCl.

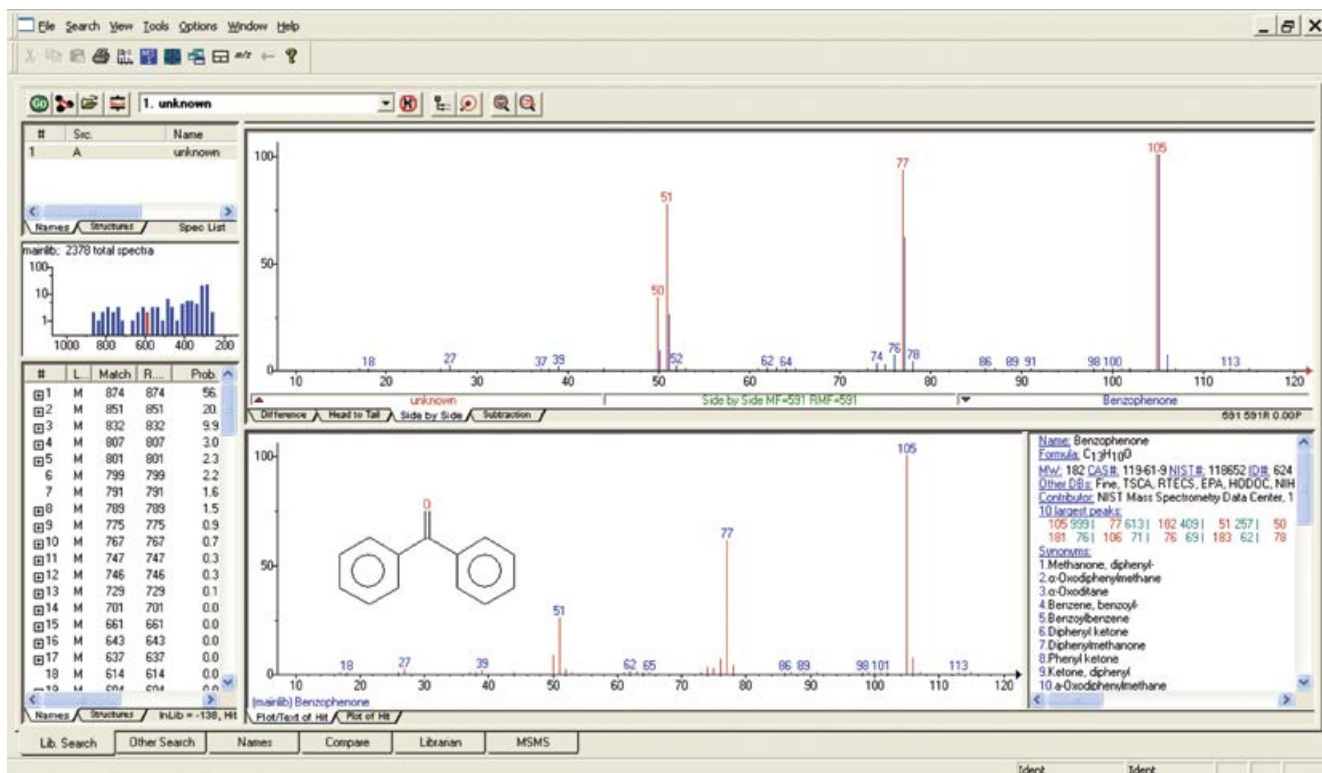

Direct export of the MS results at 166°C into the NIST database for identification of the evolved gases



SKIMMER

DOUBLE ORIFICE SOLUTION FOR HIGH-BOILING MATERIALS

DETECTION OF

- Large molecules
- Highly condensable (metal) vapors
- Permanent gases

Vertical – Top-Loading STA System and SKIMMER on Top of the Furnace

The SKIMMER coupling (realized with the STA 409 CD) actualizes the shortest possible route for gas transfer from the sample to the QMS. The SKIMMER collimates the molecules from the barrel-shaped jet expansion behind the divergent nozzle towards the QMS ion source.

The pressure reduction of the purge gas flow from atmospheric pressure down to the high vacuum behind the SKIMMER orifice is achieved in two steps along a distance of less than 20 mm. This drastically reduces the risk of condensation and thus achieves high detection sensitivity. Even metal vapors are detected by this unrivaled coupling system.

The nozzle and SKIMMER are precisely machined from either alumina or glassy carbon, allowing application temperatures of 1450°C or 2000°C in the corresponding furnaces. The molecular beams are analyzed by a quadrupole mass spectrometer up to high mass numbers of 512 u or optionally 1024 u.

Detection of Metal Vapors

Lead chloride (7.92 mg) in an argon flow of 150 ml/min exhibits evaporation starting in the melting range (487°C). The molecule ion (PbCl_2 m/z 278) and fragment ions caused by dissociation and ionization (PbCl m/z = 243, Pb m/z = 208, Cl m/z 37, Cl m/z = 35) are clearly detected far below the boiling temperature of the starting material.

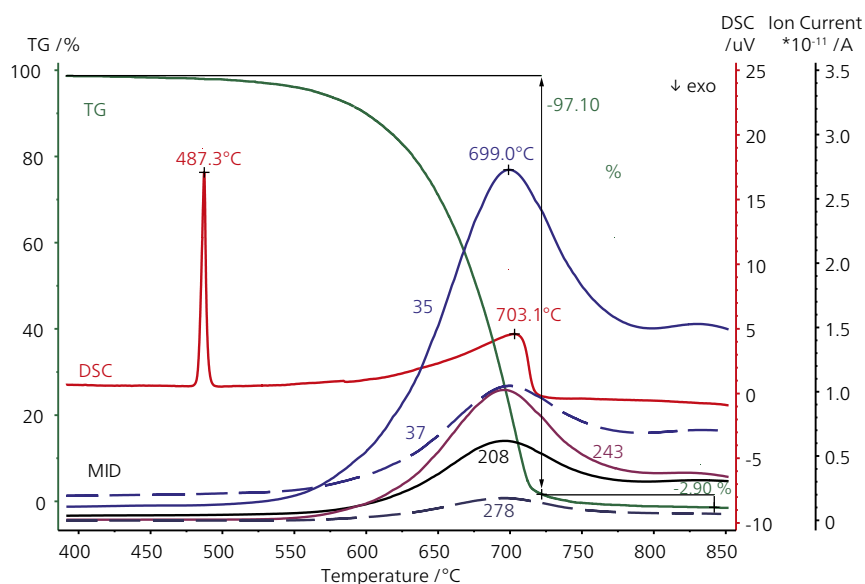

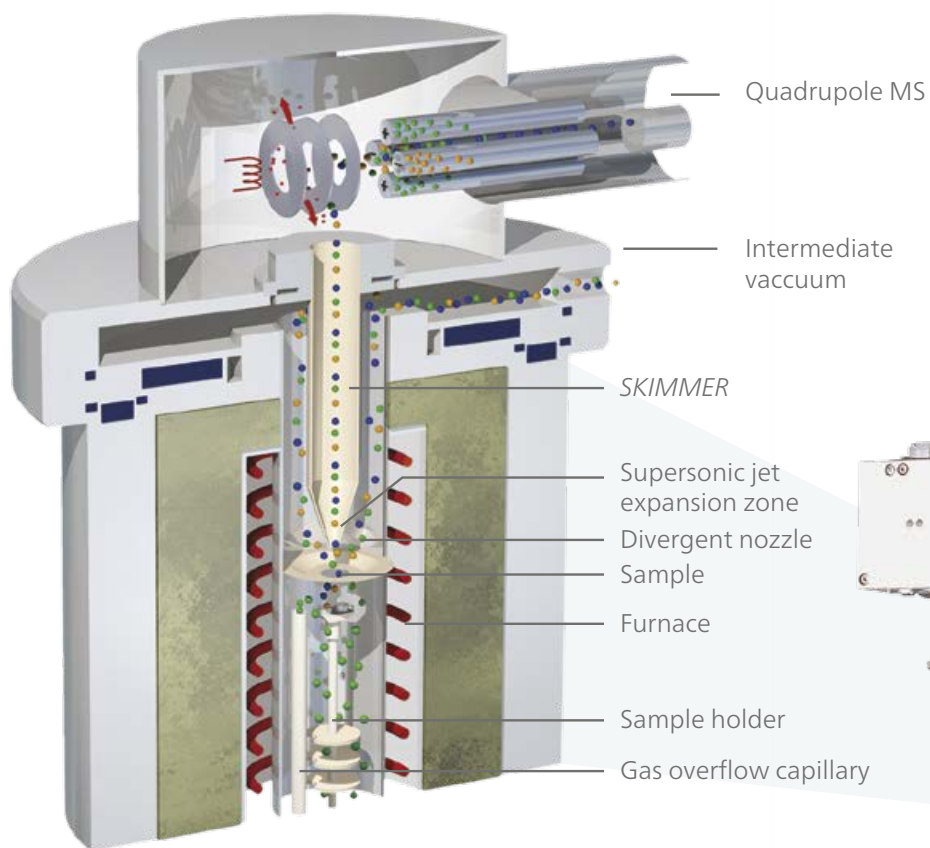

Shortest possible coupling solution via unique supersonic jet gas transfer

SKIMMER Applications

Thermal Stability of the Thermoelectric Material PbTe

Knowledge about thermal stability properties, such as phase change and evolving gases at elevated temperatures, is crucial for the development of thermoelectric materials. In this example, the thermal stability of PbTe was analyzed using the STA 409 CD coupled to a mass spectrometer via the *SKIMMER* system. The plots each show the TGA curve of the PbTe sample, but with different mass spectrometer results. PbTe starts decomposing at around 600°C. The plotted mass numbers represent the combination of the Pb and Te isotopes. The following gaseous products were detected:

PbTe Isotopes (m/z)	Pb und Te Isotopes	
332 u	$^{207}\text{Pb} + ^{125}\text{Te}$	$^{206}\text{Pb} + ^{126}\text{Te}$
333 u	$^{208}\text{Pb} + ^{125}\text{Te}$	$^{207}\text{Pb} + ^{126}\text{Te}$
334 u	$^{208}\text{Pb} + ^{126}\text{Te}$	$^{206}\text{Pb} + ^{128}\text{Te}$
335 u	$^{207}\text{Pb} + ^{128}\text{Te}$	
336 u	$^{208}\text{Pb} + ^{128}\text{Te}$	
337 u	$^{207}\text{Pb} + ^{130}\text{Te}$	
338 u	$^{208}\text{Pb} + ^{130}\text{Te}$	

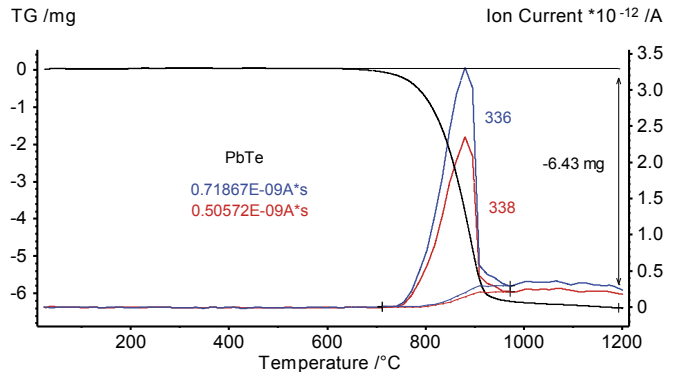
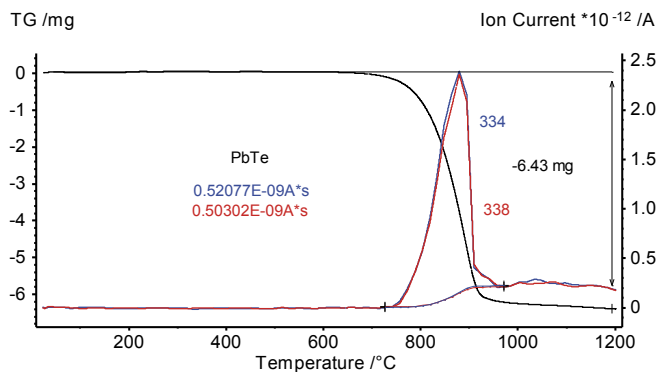
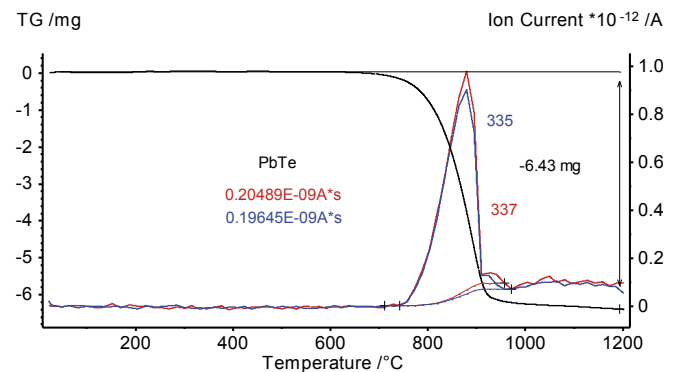
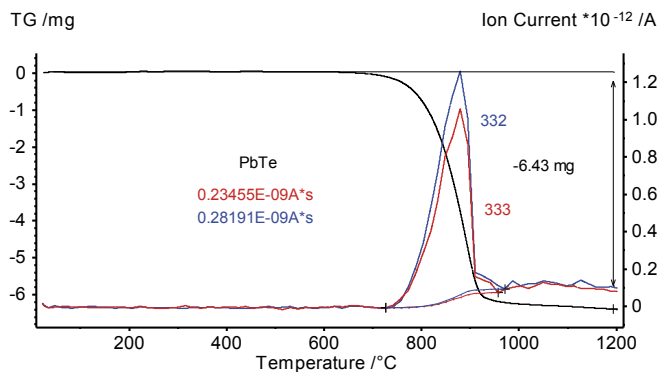

Sophisticated applications require ingenious analytical tools

Decomposition Products of Carbon Pitch

Carbon pitch is the primary product from the distillation of coal tar. It is used as a binding agent in the production of carbon anodes for aluminum smelters and graphite electrodes for electric arc furnace steel producers.

Carbon pitch powder (55.2 mg) decomposes in a nitrogen flow (50 ml/min) into aromatic compounds of high molecular weight, mainly below 600°C. Only a selection is shown here with MID curves for such substances as pyrenes ($m/z = 202$), triphenylenes ($m/z = 228$), benzo(a)pyrenes ($m/z = 252$), benzo(ghi)perylene ($m/z = 276$) and dibenzopyrenes ($m/z = 302$).

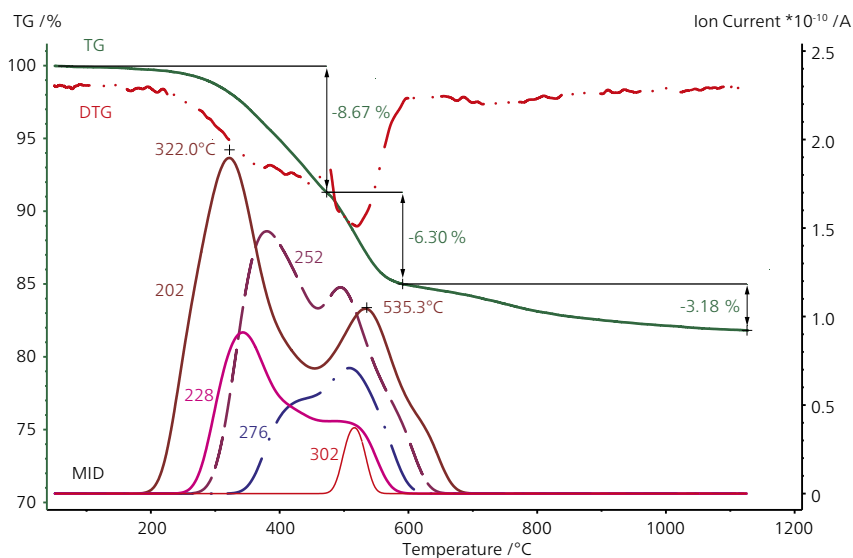

Detection of aromatic compounds of high molecular weight



PulseTA[®]

Calibration/Quantification

The quantification of MS signals requires calibration of the whole coupled system with a known type and amount of gas or solvent to control for the temperature-dependent flow properties. PulseTA[®] is a perfect tool for achieving quantitative gas detection in separate calibration runs or even online during a sample measurement. A known amount of gas is injected into the sample gas stream and the registered signal of the resulting pulse is integrated. The application of PulseTA[®] also allows for studying gas/solid reactions with stepwise control of the process via the injection of a reactive gas, and simplifies adsorption/desorption experiments.

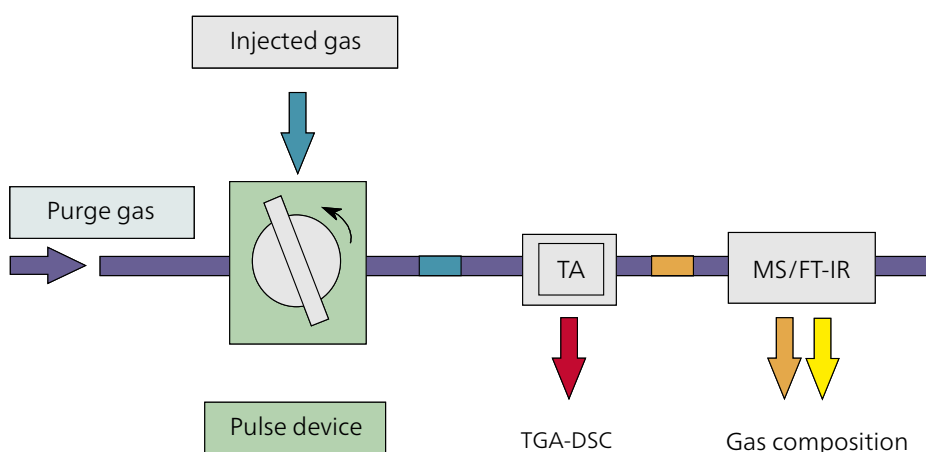

Inert gas

CO₂ pulses for calibration of a carbonate decomposition

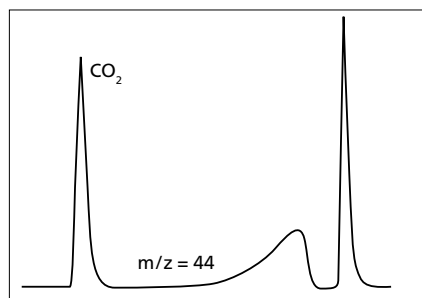

Reactive gas (gas-solid reaction)

Reduction of metal oxide by H₂ pulses

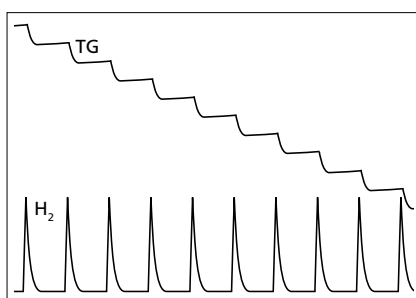

Reactive gas (adsorption)

NH₃ adsorption by a zeolithe sample

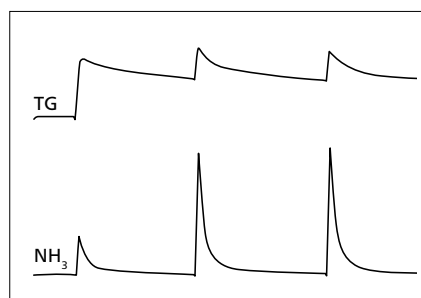

Quantification of Contaminations on an Mo Wire – Separation of Overlapping Oxidation and Carbon Burn-Up

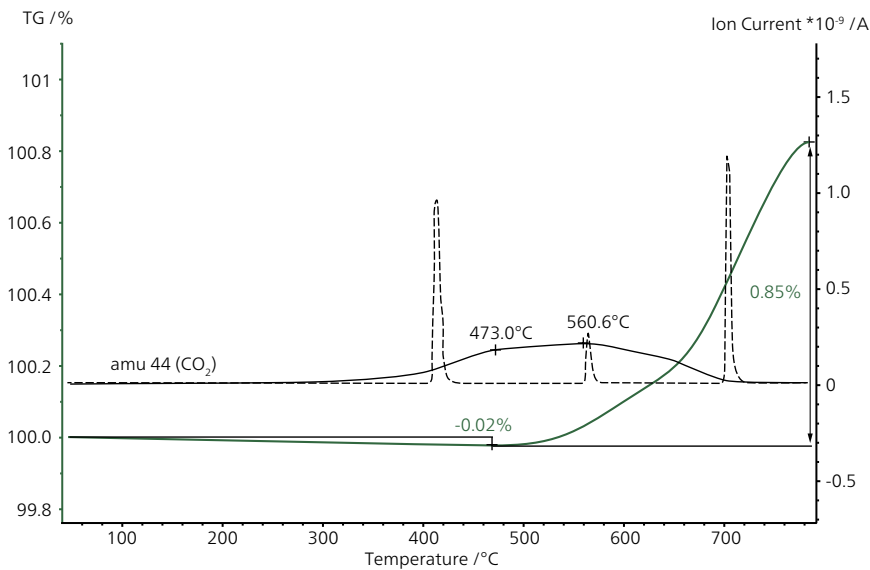

Heating of a molybdenum sample (4153.9 mg) in an Al₂O₃ beaker at a heating rate of 10 K/min in a synthetic air atmosphere. The sensitivity of the QMS 403 D *Aëolos*® is linear and temperature-independent.

In this analysis, a small mass loss of 0.02% occurred below ~500°C, followed by an increase in sample mass of 0.85% due to oxidation of the sample. At the same time, carbon impurities on the wire's surface were burnt, which can be seen from the MS signal for m/z 44 due to the CO₂ release (solid line). The carbon content was quantified at ~900 ppm by means of the NETZSCH *PulseTA*® device as follows:

During an empty run, several CO₂ pulses of defined volumes (0.25 ml and 1 ml) were injected into the STA and detected by the MS (dashed line). From the ratio of the ion current peak areas of the calibration pulses and the signal from the sample, the amount of CO₂ evolved from the sample can be calculated.



Proteus[®] Software

for TA-MS Coupling

The control of measurements with coupled TGA-QMS instruments is governed by the *Proteus*[®] software. The user gives the command for data acquisition once both the QMS and the *Proteus*[®] software are ready with parameter inputs as well as checked pressure and ion source conditions. The online data collection is simultaneous and synchronized through a triggered start to guarantee precise time and temperature correlation among all the signals from the two systems during evaluation. The user works with the two software packages on one computer and has access to the entire spectrum of possibilities for evaluating data and displaying results in the *Proteus*[®] software according to preference. The integration of the TA and QMS software based on effective data exchange from acquisition to evaluation is what makes the coupled TGA-QMS to a true functional unit.

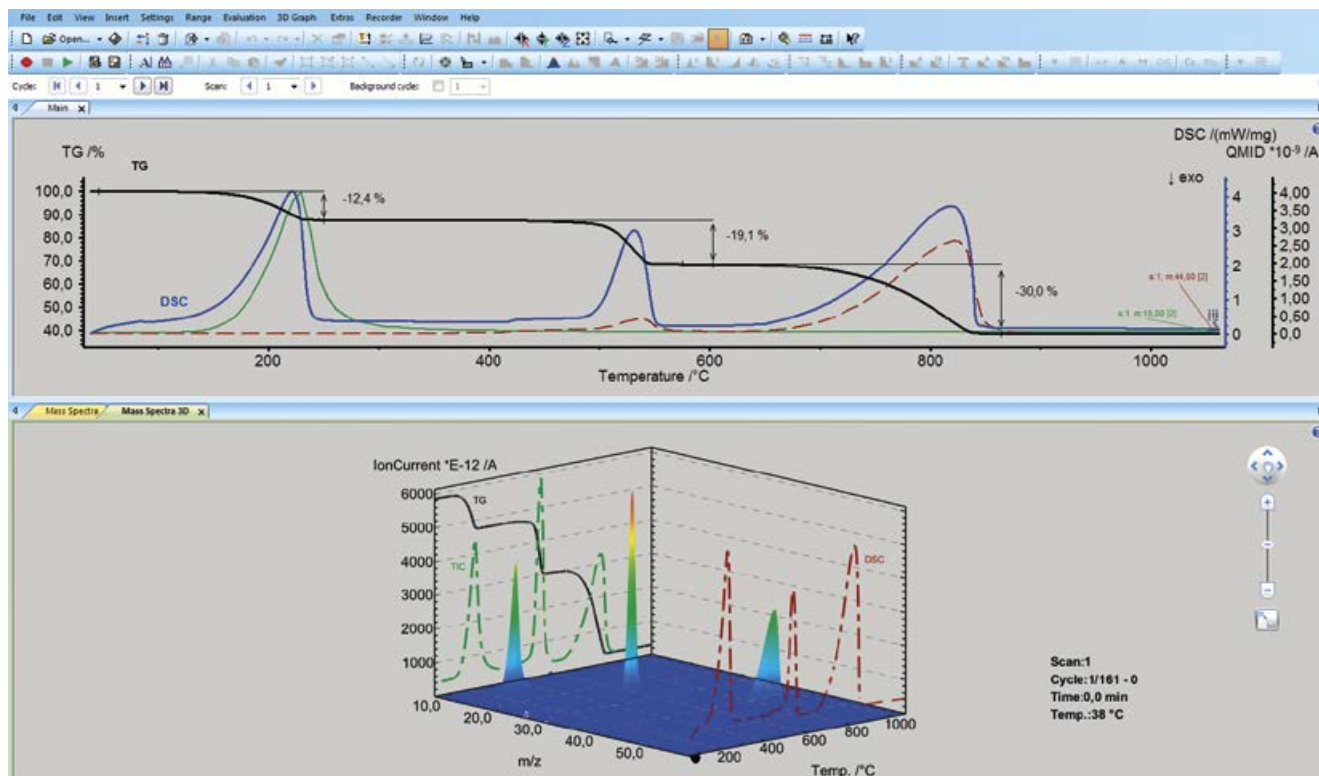

Key Software Features

- Direct import for MS data
- Evaluation of MS data within *Proteus*®
- Simultaneous start/stop of the coupled measurements (trigger system)
- Evaluation of results precisely correlated in terms of time and temperature
- Integration of MS peaks (MID and QMID peaks)
- Fast MID input of 8 mass numbers
- Several scan-bargraph ranges with fast mass range input
- Selection of up to 64 MID mass numbers
- Selection of analog scans in max. 64 channels
- Selection of scan-bargraphs or scan analog graphs with optimized rate and sensitivity in 4 different channels
- Spectra export in NIST format for identification in the NIST database
- TGA-DSC/DTA total ion current
- 3-D presentation of spectra data together with temperature, TGA and/or DSC curves, including peak determination (see plot on the left)
- Navigator to enlarge, reduce or rotate the 3-D plot (see plot on the left)
- Turbo pump and pressure displayed by software
- TGA-DSC/DTA-MID curves and scan-bargraph envelope curves: characteristic temperatures, peak areas





Various Ways of Presenting Test Results for Optimum Evaluation

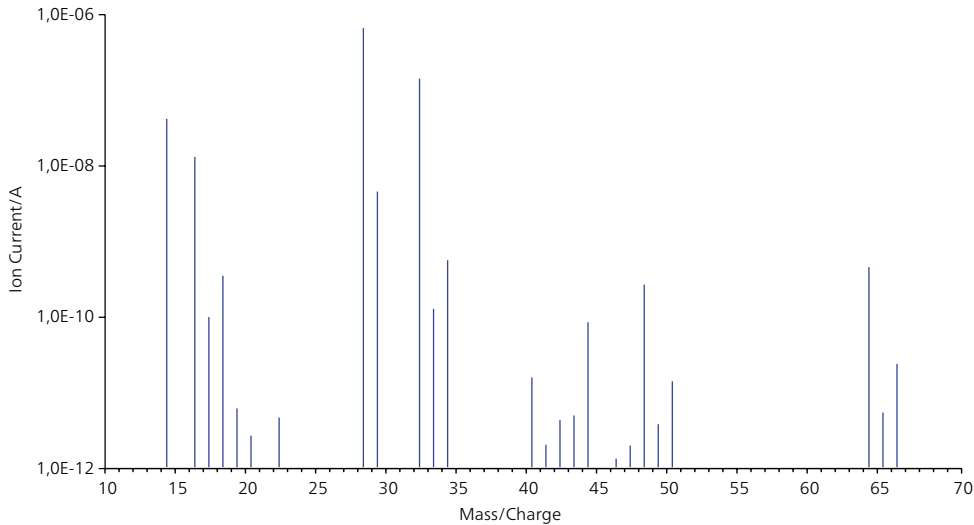

Comprehensive Information via Scan-Bargraph

A scan-bargraph is often the basis for depicting comprehensive information about all of a sample's evolved species; it allows for the selection of all mass numbers or just individual ones of interest for import into the *Proteus*[®] software as continuous MID curves. Here, one scan out of the repeated scans is shown for $\text{Nd}_2(\text{SO}_4)_3 \cdot 5 \text{H}_2\text{O}$ measured in air at 950°C.

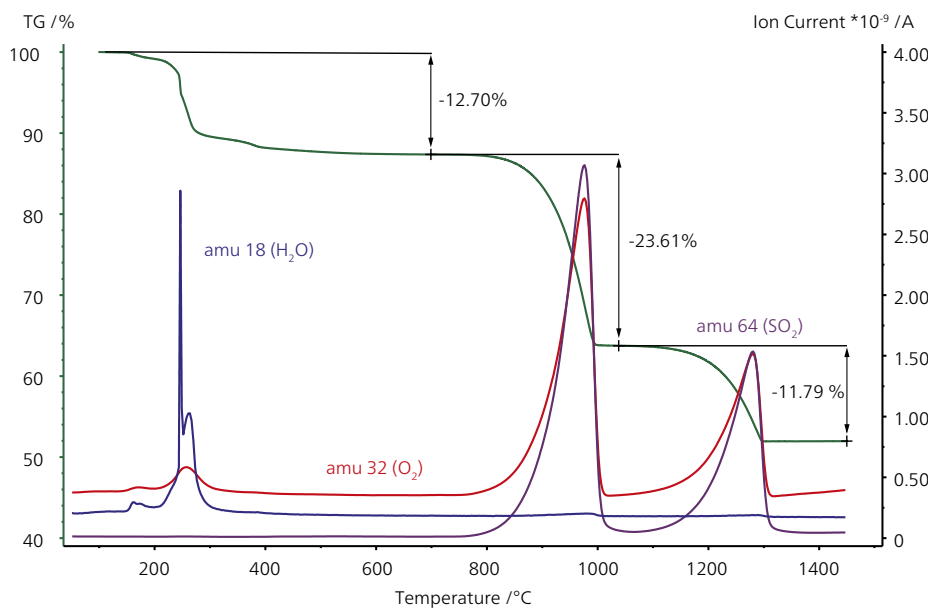

Direct Correlation Between Mass Loss and Evolved Gas via MID Curves

$\text{Nd}_2(\text{SO}_4)_3 \cdot 4.7 \text{H}_2\text{O}$ (29.53 mg) was heated at a rate of 10 K/min up to 1400°C in a nitrogen flow. The MID curves, directly imported from the coupled *Aëolos*[®], show the well separated gas evolution for water, oxygen and sulfur dioxide in perfect correlation with the TGA steps.

Key Technical Data

QMS 403 D <i>Aëolos</i> [®]		
QMS mass range 300 u*	Resolution >0.5 u*	Scan, Scan-Bargraph, MID
Electron impact ionization	Ionization energy: 25 eV to 100 eV	Two iridium cathodes, Y ₂ O ₃ -coated
Channeltron [®] SEM	Detection limit ≈ 1 ppm	
Single-step pressure reduction	10 ³ mbar to 10 ⁻⁵ mbar	Turbo molecular and membrane pump systems (oil-free)
Quartz glass capillary	Insulated; Ø 75 µm; length ≈ 2.5 m	Entire transfer heated at 300°C

* u: unified atomic mass

STA 409 CD with <i>SKIMMER</i>	
Temperature range	<ul style="list-style-type: none"> ▪ RT to 1450°C, SiC furnace ▪ RT to 2000°C, graphite furnace
Weighing range	15 g
TGA resolution	2 µg
Sensor types	TGA, DSC, DTA
<i>SKIMMER</i> systems	<ul style="list-style-type: none"> ▪ Alumina (up to 1450°C) ▪ Glassy carbon (up to 2000°C)

QMS	
QMS options	<ul style="list-style-type: none"> ▪ 1 to 512 u ▪ 1 to 1024 u
Measuring modes	Analog scan, scan-bargraph, MID
Ion source	Electron impact ionization: Energy up to 125 eV; adjustable in steps of 1 eV
Cathodes	Tungsten; others on request
Detection limit	< 10 ppb

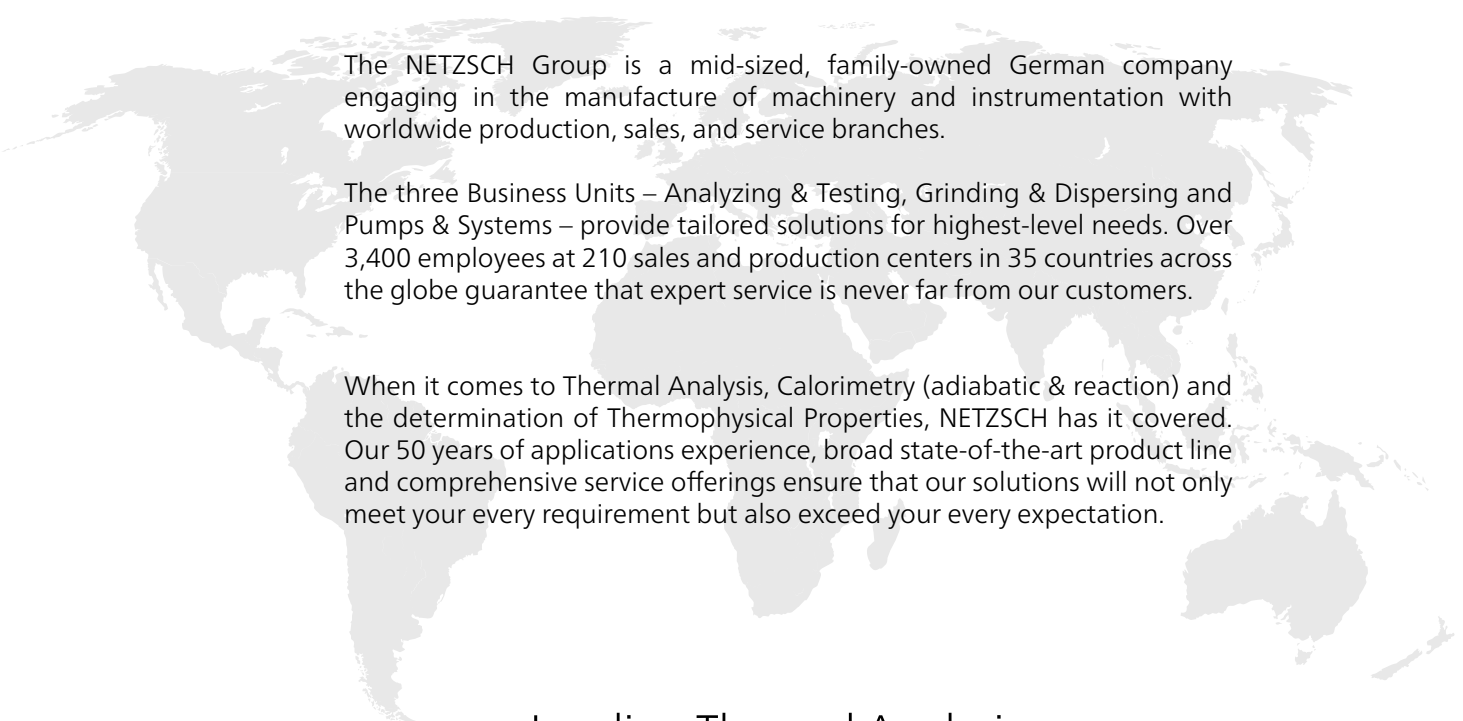

The NETZSCH Group is a mid-sized, family-owned German company engaging in the manufacture of machinery and instrumentation with worldwide production, sales, and service branches.

The three Business Units – Analyzing & Testing, Grinding & Dispersing and Pumps & Systems – provide tailored solutions for highest-level needs. Over 3,400 employees at 210 sales and production centers in 35 countries across the globe guarantee that expert service is never far from our customers.

When it comes to Thermal Analysis, Calorimetry (adiabatic & reaction) and the determination of Thermophysical Properties, NETZSCH has it covered. Our 50 years of applications experience, broad state-of-the-art product line and comprehensive service offerings ensure that our solutions will not only meet your every requirement but also exceed your every expectation.

Leading Thermal Analysis ■

NETZSCH-Gerätebau GmbH
Wittelsbacherstraße 42
95100 Selb
Germany
Tel.: +49 9287 881-0
Fax: +49 9287 881 505
at@netsch.com

NETZSCH[®]

www.netsch.com