

Tomorrow's **Systems**
for Today's **Challenges**



MultiView 4000™
MultiProbe AFM Systems



NANONICS IMAGING Ltd.

Tomorrow's Systems

MultiView 4000™

for Today's Challenges

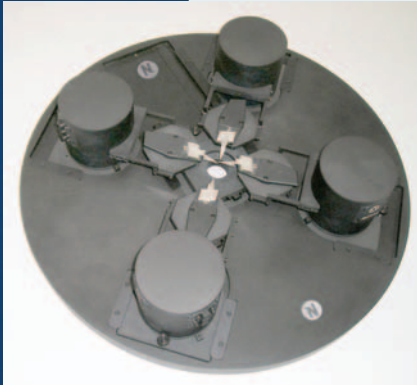

The integration of multiple probes in scanning probe microscopy (SPM) has been a dream since its earliest days of development. Nano-structure research using atomic force microscopy (AFM) has stimulated a desire to both investigate and manipulate samples in multiple contact scenarios. With the development of the MultiView 4000™, Nanonics Imaging is the first manufacturer to realize the dream of SPM multiprobe imaging. The MultiView 4000 enables the utilization of up to four probes for independent imaging and manipulation of a sample. As in all Nanonics' systems, the patented, award winning 3D FlatScan™ scanner technology is used in concert with cantilevered, optically and spatially friendly probes. This allows for maximum flexibility with the ultimate resolution achievable in scanning probe microscopy.



This flexibility is highlighted by the ability to transparently combine SPM with other optical and electron/ion optical systems. This includes combination with upright, inverted or dual microscopes as well as with Raman microprobes, SEM, FIB and SEM/FIB. This allows one to combine online, chemical and other complimentary information, which is often critical in materials characterization.

Benefits of the Multiprobe System

With multiple probes, previously unattainable measurements and analyses are now within reach. The MultiView 4000™ features independent imaging with separate probes that allow for:

- **Surface resistivity measurements** - using two, three and four point geometries.
- **Multiprobe thermal measurements and resistance measurements** - on device structures or polymeric materials.
- **Optical measurements with multiple NSOM probes for pump/probe measurements** - on optical devices and optically active materials such as semiconductors with femtosecond time and nanometric spatial resolution.
- **Optical or thermal desorption with multiple probes to excite and collect the desorbed species for chemical analysis** - on chemical structures where spatially selective desorption of such species can be directly collected into a mass spectrometer for chemical analysis, with a second cantilevered nanopipette probe.
- **Nanochemical writing with one probe while imaging with a second probe** - on a wide variety of substrates using chemicals in the gas or liquid phase
- **Nanoindentation with one probe, with simultaneous and accurate AFM and/or thermal mapping using a second probe** - on polymeric, semiconductor or other materials.

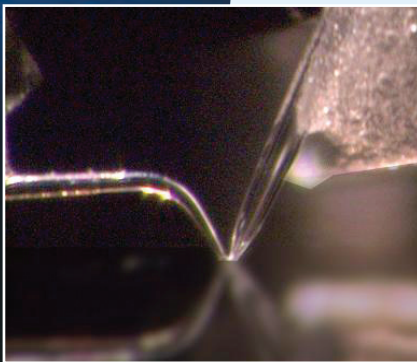

The dream, now a reality, is opening the gateway to rewarding and productive avenues of research, development and quality control. Such avenues depend upon scanning multiple probes and the sample independently, while investigating diverse and functionally important sample parameters.

The Challenges of Multiprobe Scanning

Prior to the development of the MultiView 4000™, the geometry of scanning mechanisms and probes thwarted the dream of multiple probe scanned probe microscopy. Bulky and awkward piezo scanners, which stood upright, kept the probes apart when placed side-by-side.

The probes themselves were not spatially friendly and did not allow the probe tips to approach one another.

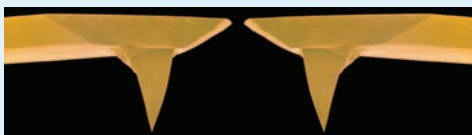
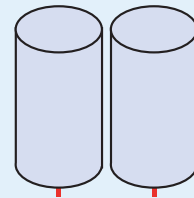

Nanonics' Solutions

The 3D Flatscan™ Scanner Technology

Unlike standard piezo scanners which keep probes separated, the 3D Flatscan™ is the perfect solution for multiprobe scanning. The design of the 3D Flatscan™ is a novel planar, folded-piezo, flexure scan design which provides the ultimate

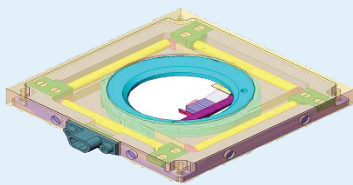

▲ 3D Flatscanner™

in AFM resolution (e.g. atomic steps in highly oriented pyrolytic graphite (HOPG)). The large vertical (axial) displacement of up to 100 microns allows for the use of multiple probes as well as the tracking of structures with very large topographical features and simultaneous lateral scanning over large areas. The ultra-thin architecture of the 3D Flatscan™ scanner provides the flexibility that is critical in developing a variety of different geometries of multiprobe systems.

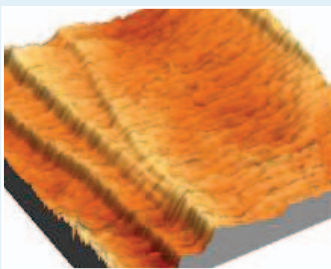

▲ Atomic Steps in HOPG

Furthermore, the 3D Flatscan™ Scanner can be incorporated into systems where conventional scan stages are too bulky and geometrically limiting. Its minimal height of 7 mm allows for easy access with high powered microscope objectives from either above or below the scanning stages.

Unique, Ultrastable, Spatially Friendly Glass Based Probes

While typical probes do not permit the probe tips to come within close proximity to one another, Nanonics has developed spatially and optically friendly glass based probes that allow for a close approach of the probe tips – a critical feature of multiprobe imaging systems. Such Nanonics' exposed probe technology permits the approach of two probes to within 10 nm, as well as independent scanning of each probe.

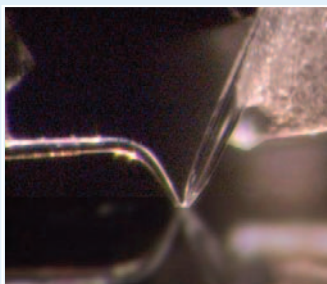

▲ Dual Probes in Contact with AFM Feedback

Not only do Nanonics' glass based probes offer excellent imaging in AFM modes - the probes have unparalleled aspect ratios and support deep trench imaging as well as side wall imaging. They also permit singular electrical imaging and thermal imaging with glass encased nanowires. Nanopipette probes further allow for gas and liquid chemical writing.

Normal Force Tuning Fork Feedback

The MultiView 4000™ employs the ultimate in SPM feedback technology. Normal force tuning fork technology with high Q factor phase feedback is used to permit unprecedented control of the probe tip/sample separation. Tuning forks in normal force mode with phase feedback not only permit the best AFM imaging available today but, in addition, there are no user adjustments needed with such a feedback mechanism. This allows for ease of operation with the ultimate in AFM resolution, better than any beam bounce technology. Furthermore, there is no feedback laser interference, for example, when working with semiconductor devices or fluorescent materials.

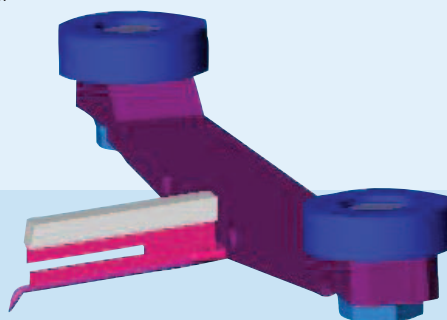

Modular Design Open Architecture

The unique, modular design of the MultiView 4000™ allows for the future upgrade of one probe to two, three or four probes. The MultiView 4000™ has a geometry that actually surpasses the open architecture of the Nanonics' MultiView Series, which established the uniquely open optical and electron/optical axes above the probe and below the sample scanner. The MultiView 4000™ continues in this tradition and offers a completely free optical axis from above the probe, below the sample and for 270° around the probe. The MultiView 4000™ boasts a 4.5 mm working distance from above the probe for ultrahigh resolution optical or electron/optical viewing probes on opaque samples.

› Start with one probe &

› Upgrade to two

› or Upgrade to four



MultiView 4000™

Applications of the MultiView 4000™

With multiple probes, the possibilities are only limited by the imagination. Numerous end-uses of the MultiView 4000™ can be applied to various research scenarios:

Dual Probe Electrical Measurements

Nanonics' ultrastable solid wire electrical probes allow for low contact resistance of a few tens of ohms and full insulation with glass up to the probe tip for high electro-potential resolution. Glass coating insulation can be overcoated with metal to emulate coax geometries for ultrahigh sensitivity electrical imaging. Finally, the probe with its high cantilever design minimizes cantilever electrical interference.

The properties of these electrical probes include:

- Ultrastable solid nanowires with exposed probe tips
- Low contact resistance and full insulation with glass up to the probe tip for high electro-potential resolution
- Glass coating insulation which can be overcoated with metal to emulate coax geometries for ultrahigh sensitivity electrical imaging
- High cantilever design that minimizes cantilever electrical interference

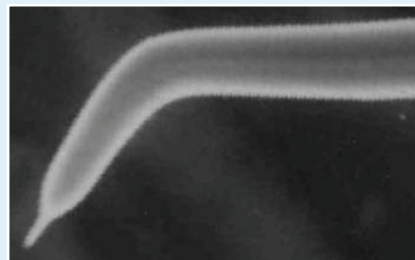
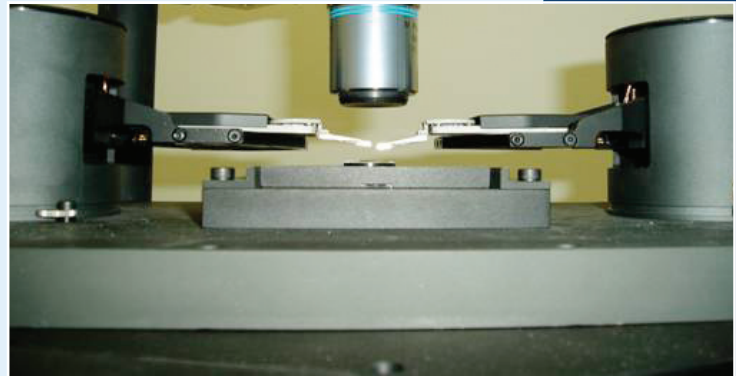

Dual Nano-Wire Thermal Conductivity Measurements

Nanonics has also developed Dual Wire Thermo-Resistance probes for use with the MultiView 4000™. In this specialized probe, two platinum wires are stretched through the nanopipette and are fused together at their tips. This fused junction has a resistance that is temperature-dependent. The unique probe allows for simultaneous measurement of surface topography and thermal conductivity even in intermittent contact mode. With multiple probes, heat can be introduced at specific locations and detected at other locations. The probes can also be used for resistance measurements. Only the MultiView 4000™ utilizing Dual Wire Thermo-Resistance probes with their exposed probe tip is capable of these functions.

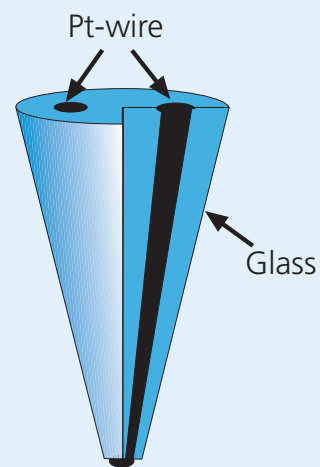

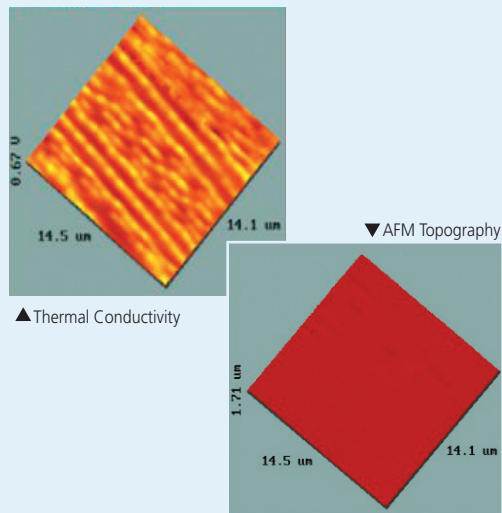

A thermal conductivity image of a static random access memory (SRAM) device is compared with the AFM topography. As contact is made in different regions of the SRAM with the thermal conductivity probe, the probe tip cools to different levels depending on the thermal conductivity of the material that is sitting under the chemically mechanically polished flat surface. The resulting image is obtained by determining the current alterations that had to be affected in order to keep the current flowing past the point resistance at a constant value.

Dual Probe Optical Measurement

With two cantilevered, near-field optical probes with exposed tips, optical pump/probe experiments can now be performed. In this example light is injected through one probe and is guided through the sample which is a fiber. With the second probe in place, this injected light can be collected and analyzed both spatially and temporally.

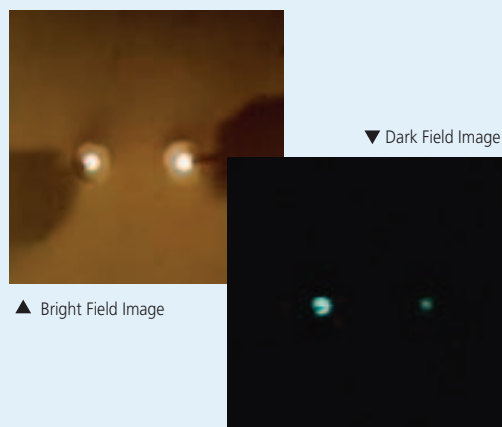
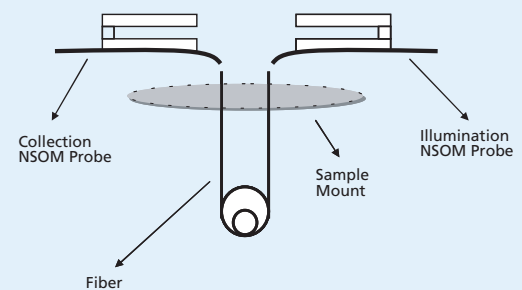

A diagrammatic illustration is displayed above with a bright field optical microscopic image shown to the left. In this image two NSOM probes are seen in AFM contact with the input and output of the fiber waveguide. In the dark field image, the injected light from the illuminating 100nm near-field optical probe on the right is seen as a small spot of reflected light from the waveguide. This injected light is then guided through the fiber, and the intense spot on the left in the dark field image is collected and analyzed, both spatially and temporally, at the output of the waveguide with a second probe whose silhouette is clearly seen.

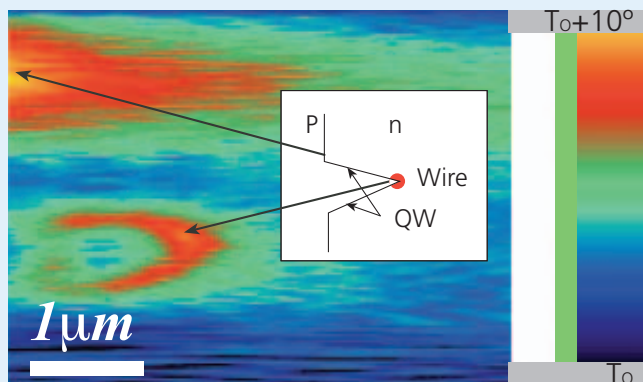
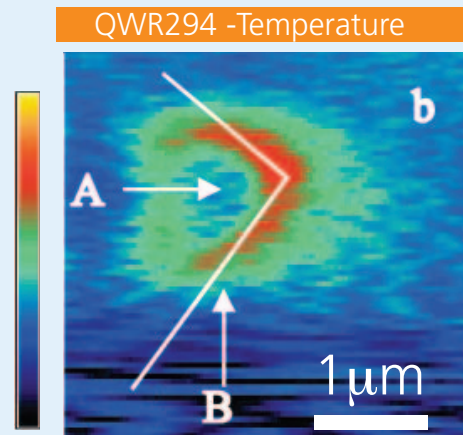
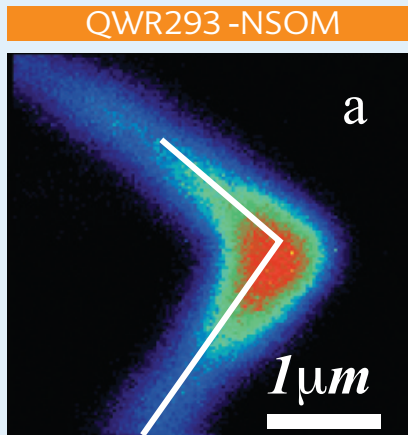

The MultiView 4000™ System simplifies the task of optically and thermally profiling on-line an optoelectronic device. Seen in these images (above) are the optical distribution of light in a quantum wire laser (NSOM) and the thermal distribution around the laser. The image below includes the p contact region in the thermal image. As can be seen, the thermal and light distribution bear no correlation to one another, but rather the thermal distribution is bowed towards the p contact where electrical charge is injected.

MultiView 4000™

Tomorrow's Systems for Today's Challenges

Dual Probe Nanoindentation with On-line Ultra-Resolution AFM Profiling

The MultiView 4000™ head can be integrated with a Raman microscope to create on-line a chemical map of a nanoindentation with one probe while profiling with ultrahigh resolution using a second AFM probe.

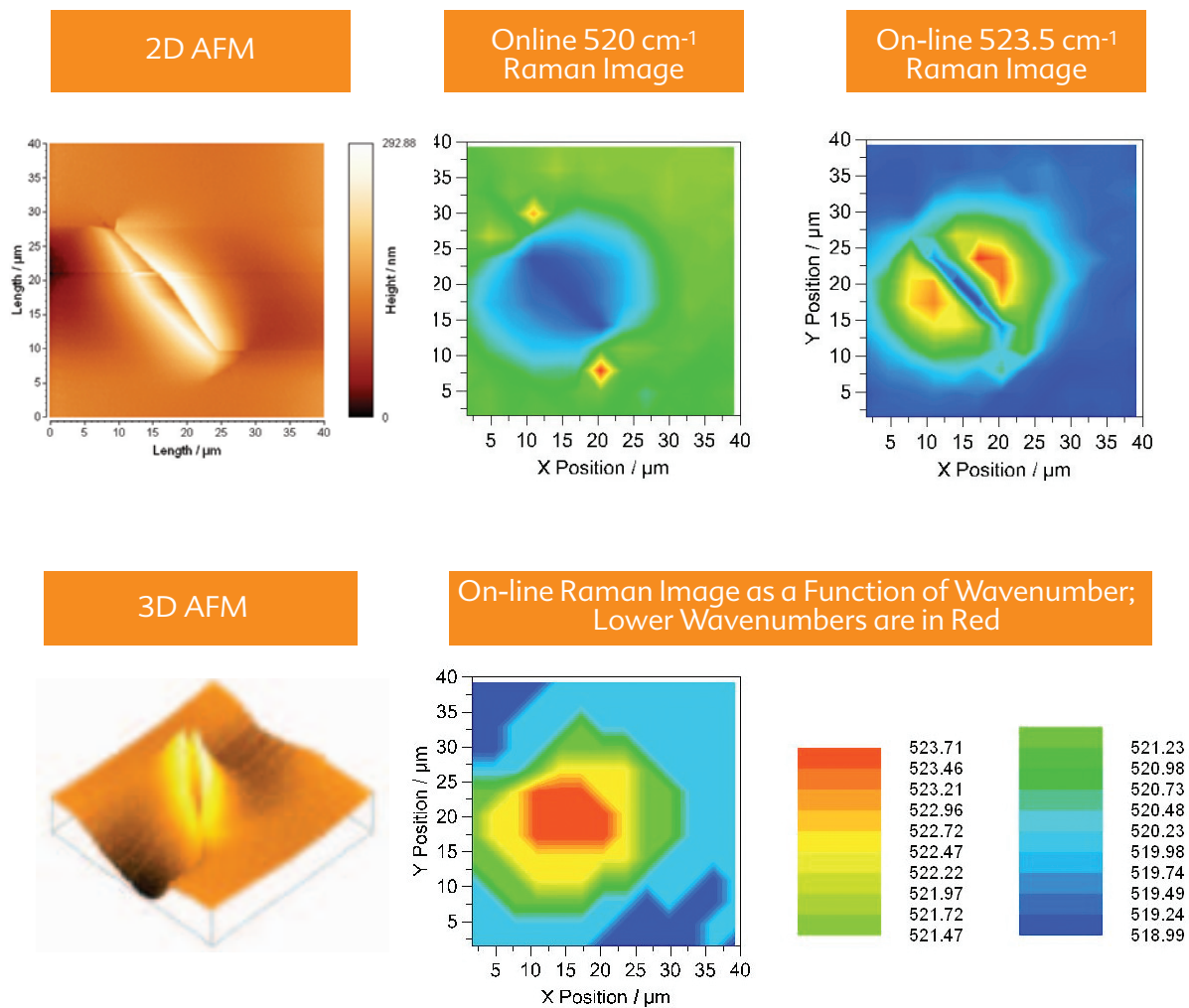

The images above show the utility of two probes on-line in nanoindentation experiments. With the nanoindentation shown here it would be impossible to perform the imaging task with only the indenting probe. It also shows the great utility of the optically friendly nature of the multi probe system which in this case permits an on-line Raman map for chemically characterizing the nanoindentation. All Nanonics MultiView Systems can be integrated with any optical or electron/ion optical microscope system.

System Specifications

Available Modes of Operation

AFM	AC Mode Contact Mode (Optional) All AFM Modes of Operation with probe or sample scanning
Near-field Optical Imaging & Illumination	Transmission, Reflection, Collection, Illumination
Differential Interference Contrast	Reflection and Transmission
Refractive-Index Profiling	Reflection and Transmission
Thermal Conductivity and Spreading Resistance Profiling	Contact or AC mode No Feedback Laser Induced Extraneous Carriers in Semiconductors with tuning fork feedback option
On-line Far-field Confocal with Raman and Fluorescence Spectral Imaging	Reflection and Transmission Tip Enhanced Raman Scattering for Selective Raman Scattering of Ultrathin Layers such as Strained Silicon
NanoLithography	NanoFountainPen delivery of chemicals and gases; Near-field photolithography; and Other conventional means of nanolithography such electrical oxidation etc; with on-line analysis with an additional probe
NanoIndentation	Application of MegaPascals of force, allowing exact positioning and controlled application of force with on-line analysis with an additional probe
	All the above modes of operation are provided fully integrated with on-line AFM imaging.

SPM Scan Head Specifications

Sample Scanner	Piezoelectric Based Flat Scanner (3D Flat Scanner™) Height 7mm
Probe Scanner	Up to 4 independently controlled piezoelectric Flat Scanners (3D Flat Scanner™) modules Height 7mm
SPM Scan Range	30 microns (XYZ) for each probe scanning module 100 microns (XYZ) sample scanning only 130 microns (XYZ) with sample and probe scanning 160 microns (XY) with sample and two probe scanning
Scanner Resolution	< 0.05 nm (Z) < 0.15 nm (XY) < 0.02 nm (XY) low voltage mode
Rough Positioning	<i>Sample rough positioning:</i> XY motorized stage – range 5mm – resolution 0.25 micron <i>Tip rough positioning:</i> XY motorized stage – range 5mm – resolution 0.25 micron Z motorized stage – range 10mm – resolution 0.065 micron
Feedback Mechanism	Tuning fork (Standard) Beam bounce Attachment (Optional)
Sample Geometries	<i>Sample size:</i> Up to 16 mm standard Up to 34mm for upright microscope operation Up to 55mm without sample scanning Custom sample sizes up to 200mm also available Unconventional Geometries: Hanging samples for edge profiling and other unconventional geometries possible
Probes	Specialized glass probes with exposed tip geometry & all forms of silicon cantilever probes can be used

Imaging Resolution

Far-field	Diffraction Limited
Optical	Optics providing 500 nm diffraction limited non-confocal operation
Confocal	200 nm
NSOM	100 nm on installation; 50 nm probes available
Topographic	Z noise 0.05 nm rms. X.Y lateral resolution: convolution of tip diameter & sample
Thermal	From 100 nm
Resistance	From 25 nm

Thermal & Resistance Imaging

Temperature	300 °C or greater, depending on sample to be investigated
Thermal	Unique exposed tip dual platinum nanowire probes fully insulated with glass coating: Thermal Sensitivity 0.01°C Measured Resistance Change per degree; 0.38 Ω/°C
Resistance	Unique exposed tip platinum nanowire probes fully insulated with glass coating and allowing for coax geometry structures: Ultra high electro potential resolution Few tens of ohms contact resistance for probes <100nm Electrically stable & free from oxidation

Electronics & Software

Control System	<p>Integra Controller</p> <p><i>Specifications:</i> Supports various imaging modes including AFM (contact and non-contact), phase, error signal and NSOM</p> <p>Up to 8 data channels can be read and imaged simultaneously All ADCs are 16 bit and DACs have 16-bit resolution Image size continuously variable from 2x2 to 1024x1024 Inbuilt lock-in amplifier</p> <p>There are two alternative software packages available:</p> <p>Quartz Software Package Specifications: User friendly 32-bit Windows application available for Windows 95/98, NT and XP Intuitive scan parameter setup. Image and line profiles displayed in real time. 2-D and 3-D image rendering. Extensive image processing options. Comprehensive image analysis features including: cross section, particle analysis, fractal analysis and z-data histogram. Import data as Windows bitmaps and ACSII. Export data as TIFF and Windows bitmaps and ACSII</p> <p>LabView Software Package Specifications User Friendly LabVIEW SPM based software for PCI-7344 with the following specifications: AUX Data acquisition. Image and line profiles displayed in real time. Intuitive scan parameter setup. Open Design enabling Customization by User and interfacing to other LabVIEW modules</p>
----------------	--

	Nanonics Controller and software package based on Windows XP and Windows XP LabView based software package. Real time image display, image acquisition up to 8 channels. Full access to all signals and readily integrated with external signals from other sources. Analysis software including all standard image processing routines and 3D rendering including collages of multiple signals. Software modules available for spectral acquisition and analysis including Raman and fluorescence spectra, nanoindentation, nanolithography including NanoChemwrite™ Fountain Pen NanoChemistry™ software suite
Data Acquisition	From 2x2 to 1024x1024 and multiple Z acquisition
Analog Lock-in	Provides quadrature output. Information is readily available on R/Θ and I/Q in output bandwidths of 15kHz (depending on DT card in use; the controller can give up to 100 kHz)
Frequency Synthesizer	Direct Digital Synthesizer (DDS) system for frequency and phase adjustment with 32-bit frequency determination and 20-bit phase determination. This system uses three independent generators. Two of these generators provide quadrature for lock-in processing and the third generator is used for exciting with an autophase algorithm. The system uses a clock frequency of 20 MHz with a stability of 5 ppm and provides frequency resolution of <5 mHz
Amplitude	0 to 5 V p-p and maximum resolution of up to 0.2 mV Amplitude, Phase and Frequency of the oscillator can be controlled with 100 kHz updates
X, Y and Z High Voltage Outputs	-145V to +145V

On-line Optical and Electron/Ion Optical Integration

Type	Far-field, Confocal Optics , Near-field, micro-Raman; Scanning Electron Microscope (SEM) or Focused Ion Bean (FIB)
Integration	<p>Free optical axis from above and below the sample for on-line optical or electron/ion optical characterization</p> <p>Integration with all forms of optical microscopes including upright microscopes and upright microscope probe stations</p> <p>Integration with all standard microRaman 180 degree backscattering geometry configurations, inverted microscopes and state of the art dual (4Pi) microscopes such as Nanonics unique dual microscope</p> <p>All conventional far-field optical modes of operation are available, including phase imaging and differential interference contrast</p> <p>NSOM with any optical microscope including; upright, inverted and dual</p> <p>The completely free optical axis from above and below in all Nanonics MultiView Systems also allows for integration with (4Pi) dual microscopes for non-linear optical techniques including second harmonic and sum frequency generation microscopes, third harmonic imaging, coherent anti-Stokes Raman microscopes and stimulated emission depletion microscopy</p> <p>All Nanonics Systems and all Nanonics Multiple Probe Systems are unique scanned probe microscopes with a completely free axis above the sample and thus can be integrated transparently into scanning electron microscopes including field emission SEM's or focused ion beam systems</p>
Minimum Working Distance (WD) with High Numerical Aperture (NA) Optical Microscope Lenses	<p><i>Upright Microscope or SEM or FIB:</i> Optical Objective: 100 x 0.75NA Objective WD: 4.8mm</p> <p><i>Inverted Microscope:</i> All available objectives including oil immersion optical objectives</p>
Detectors	Photomultiplier Tube, Avalanche Photo Diode or InGaAs Detectors
Lasers	Variety of lasers can be used from deep UV to near-IR
Video system	On Line CCD video imaging



NANONICS IMAGING Ltd.

Manhat Technology Park,
Jerusalem 91487, Israel
Tel: +972-2-678-9573
Fax: +972-2-648-0827
US Toll-free: 1-866-220-6828
www.nanonics.co.il
email: info@nanonics.co.il