

BACTRON® 110 – 120 Volts

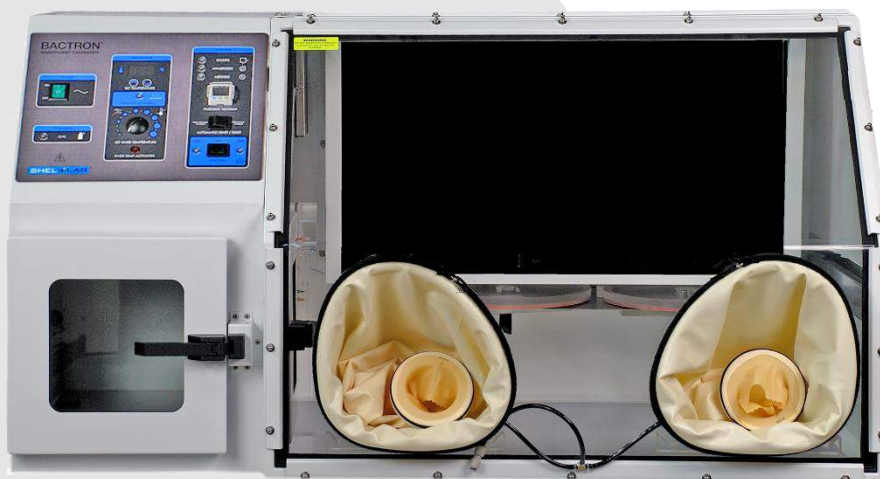

Installation and Operation Manual

BACTRONEZ

BACTRONEZ Anaerobic Workstation 110 - 120 Volts

Installation and Operation Manual

Part number (Manual): 4861701

Revision: August 27, 2014

The BACTRONEZ does not come with all of the accessories required for operation. Please see the [Required and Useful Accessories](#) section on page 8 for required items and ordering information.

These units are TÜV CUE listed as Climactic Chambers (Anaerobic Chambers) for professional, industrial, or educational use where the preparation or testing of materials is done at approximately atmospheric pressure and no flammable, volatile, or combustible materials are being heated.

These units have been tested to the following requirements:

CAN/CSA C22.2 No. 61010-1:2012

CAN/CSA C22.2 No. 61010-2-010 + R:2009

UL 61010A-2-010:2002

UL 61010-1:2012

EN 61010-1:2010

EN 61010-2-010:2003

TABLE OF CONTENTS

INTRODUCTION	5
<i>General Safety Considerations</i>	5
<i>Engineering Improvements</i>	6
<i>Contacting Assistance</i>	6
RECEIVING YOUR BACTRONEZ	7
<i>Inspecting the Shipment</i>	7
<i>Required and Useful Accessories</i>	8
<i>Returning the Shipment</i>	8
<i>Recording Data Plate Information</i>	9
GRAPHIC SYMBOLS	10
INSTALLATION	12
<i>Ambient Conditions</i>	12
<i>Location</i>	12
<i>UV Lighting</i>	12
<i>High Altitude Locations</i>	13
<i>Power Source</i>	13
<i>Lifting and Handling</i>	14
<i>Leveling</i>	14
<i>Gas Source</i>	15
<i>BACTRONEZ Orientation</i>	15
<i>Workspace Chamber Orientation</i>	16
<i>Pass Box Orientation</i>	16
<i>Cleaning</i>	17
CONTROL PANEL OVERVIEW	18
OPERATION	22
<i>Theory of Operation and Major Component Functions</i>	22
<i>Setting up the BACTRONEZ</i>	25
<i>Set up the Gas Supply</i>	27
<i>Single Gas Connection</i>	28
<i>Dual Gas Connection</i>	28
<i>Connecting To an In-House Vacuum System</i>	29
<i>Connecting the Vacuum Pump</i>	29
<i>Filling the Manometer</i>	29
<i>Installing the Arm Port Doors</i>	29
<i>Connecting the Foot Pedal Assembly</i>	30
<i>Shelving Installation</i>	31
<i>Power the BACTRONEZ</i>	31
<i>Establishing an Anaerobic environment</i>	32
<i>Installing the Sleeve Assemblies</i>	34
<i>Chamber Entry</i>	35
<i>Moving In The Pressurized Chamber</i>	35
<i>Verifying an Anaerobic Atmosphere</i>	36
<i>Troubleshooting The Presence of Oxygen</i>	37
<i>Exiting the Chamber</i>	38
<i>Setting the Incubator Temperature</i>	39
<i>Setting the Over Temperature Limit</i>	39
<i>Operating the Pass Box</i>	40
<i>Loading the Workstation</i>	42
<i>Reactivating the Catalyst Cartridge</i>	42

<i>Calibrate the Incubator Temperature display</i>	43
<i>Gas Conservation Methods</i>	44
<i>Activated Charcoal Scrubber and Rejuvenation Cycle</i>	45
<i>Attaching Equipment to the Chamber Accessory Outlets</i>	45
<i>Deionized and Distilled Water</i>	46
<i>Humidifying the Incubator</i>	46
<i>Pressure Unit Conversion</i>	46
USER MAINTENANCE	47
<i>Daily Maintenance</i>	48
<i>Normal Gas Consumption</i>	48
<i>Leak Diagnosis – Unit Full</i>	49
<i>Leak Check – Empty Unit</i>	50
<i>Door Gasket Maintenance and Usage</i>	51
<i>Sleeves Maintenance and Usage</i>	51
<i>Replacing the Sleeve Cuffs</i>	52
<i>Cleaning</i>	53
<i>Disinfecting</i>	54
<i>Vacuum Pump Maintenance</i>	54
<i>Maintaining the Acrylic Glass Panels</i>	55
<i>Electrical Components</i>	55
<i>Condensation and the Dew Point</i>	56
UNIT SPECIFICATIONS	57
<i>Weight</i>	57
<i>Work Station Dimensions</i>	57
<i>Stand Dimensions</i>	58
<i>Incubator Dimensions</i>	58
<i>Pass Box Interior Dimensions</i>	58
<i>Pass Box Plate Capacity</i>	58
<i>Pass Box Volume</i>	58
<i>Chamber Capacity</i>	59
<i>Total Plate Capacity</i>	59
<i>Temperature</i>	59
<i>Power</i>	59
PARTS LIST	60
<i>Ordering Parts and Consumables</i>	61
ACCESORIES	62

INTRODUCTION

Thank you for purchasing a Shel Lab BACTRONEZ Anaerobic Chamber Workstation. We know that in today's competitive marketplace, customers have many choices when it comes to constant temperature equipment. We appreciate you choosing ours. Our continued reputation as a leading laboratory product manufacturer rests with your satisfaction. Sheldon Manufacturing, Inc. stands behind our products, and we will be there if you need us.

BACTRONEZ workstations are intended for professional, industrial, and educational applications as anaerobic workstations suitable for the cultivation of clinical bacteria. These workstations are not intended for use at hazardous or household locations. Only use this equipment for its intended spectrum of applications; any alterations or modifications void the warranty.

Before using the BACTRONEZ read this entire manual carefully to understand how to install, operate, and maintain the workstation in a safe manner. Keep this manual available for use by all workstation operators. Ensure that all operators are given appropriate training prior to using the BACTRON.

GENERAL SAFETY CONSIDERATIONS

Note: Failure to follow the guidelines and instructions in this manual may create a protection impairment by disabling or interfering with the unit's safety features. This can result in injury or death.

Your BACTRONEZ and its recommended accessories are designed and tested to meet strict safety requirements. The workstation is built to connect to a wall power source using the specific power cord type shipped with the unit.

For continued safe operation of your BACTRONEZ, always follow basic safety precautions including:

- Follow all local or regional ordinances in your area regarding the use of this unit. If you have any questions about local regulations, please contact the appropriate agency.
- Use only approved accessories. Do not modify system components. Any alterations or modifications to your BACTRONEZ can be dangerous and void your warranty.
- Always plug the BACTRONEZ power cord into an earth grounded electrical outlet that conforms to national and local electrical codes. If the workstation is not grounded properly, parts such as knobs and controls can conduct electricity and cause serious injury.
- Avoid damaging the power cord. Do not bend it excessively, step on it, or place heavy objects on it. A damaged cord can be a shock or fire hazard. Never use a power cord if it is damaged.
- Do not position the workstation in such a manner as to make it difficult to unplug the unit in the event of an emergency.
- Ensure that the vacuum line from the vacuum pump to the workstation is not kinked, and that the pump is placed in a location with adequate ventilation to avoid overheating.
- Do not attempt to move the workstation while in operation.

INTRODUCTION (CONTINUED)

ENGINEERING IMPROVEMENTS

Sheldon Manufacturing continually improves all of its products. As a result, engineering changes and improvements are made from time to time. Therefore, some changes, modifications, and improvements may not be covered in this manual. If your unit's operating characteristics or appearance differs from those described in this manual, please contact your Shel Lab dealer or distributor for assistance.

CONTACTING ASSISTANCE

If you are unable to resolve a technical issue with the BACTRON, please contact Sheldon Technical Support. Phone hours for Sheldon Technical Support are 6am – 4:30pm Pacific Coast Time (west coast of the United States, UTC -8).

Please have the following information ready when calling or emailing Technical Support: the **model number** and the **serial number**. These will be found on the unit's data plate, which is located in the workspace chamber next to the inner pass box door. See page 9.

EMAIL: tech@shellab.com PHONE: 1-800-322-4897 extension 2 or (503) 640-3000 FAX: (503) 640-1366

Sheldon Manufacturing INC.
P.O. Box 627
Cornelius, OR 97113

RECEIVING YOUR BACTRONEZ

INSPECTING THE SHIPMENT

Before leaving our factory, all BACTRONEZs are packaged in high-quality shipping materials to provide protection from transportation-related damage. When the unit departs the factory, safe delivery becomes the responsibility of the carrier. Damage sustained during transit is not covered by the BACTRONEZ's warranty.

This makes it important that you inspect your BACTRONEZ for concealed loss or damage to its interior and exterior when receiving it. If you find any damage to the workstation, follow the carrier's procedure for claiming damage or loss. If the carton is not damaged, open the carton and remove the contents. The unit should come with an Installation and Operation Manual, warranty card, and a Certificate of Compliance.

Verify that the correct number of components are included with the unit:

Anaerobic Indicator Strips (5 packets)



2 Arm Port Doors, Left and Right



PN 9900699 / PN 9900698

Shelf Spacers (3)



5680502

Sleeve Cuff Assemblies
2 (Size 8 Medium)



9990738M

Catalyst Cartridge (1)



9990759

Power Cord 5-15 NEMA (1)



1800540

Carefully check all packaging before discarding. Save the shipping carton until you are certain that the unit and its accessories function properly.

RECEIVING (CONTINUED)

REQUIRED AND USEFUL ACCESSORIES

The BACTRONEZ Does not include a vacuum pump, foot pedal assembly, an additional catalyst for use when the factory installed catalyst needs to be regenerated, or an AMG gas regulator. It also does not come with an LED viewing light or Petri plate racks.

A vacuum source, foot pedal assembly, AMG gas regulator, and second catalyst are necessary for the operation of the BACTRONEZ.

Catalyst Cartridge



9990759

Foot Pedal Unit



9990735

Gas Regulator, AMG



7150511

LED Lamp Unit



9730514

Petrie Dish Rack
(2 X 11 inches)



5110729

Vacuum Pump 120V



9740502

Order part number 917-995-0005 to purchase all these items as a package. Items may also be purchased individually. [Please see the Shel Lab website for pricing.](#)

RETURNING THE SHIPMENT

If you must return the BACTRONEZ for any reason, contact your Shel Lab service representative for a return of material authorization (RMA). You must provide the unit's data plate information for an RMA. See Recording Data Plate Information on the next page.

Returns without RMAs will not be accepted. BACTRONEZs that have been exposed to contaminants such as, pathogenic microorganisms or toxic substances, are required to undergo a decontamination procedure prior to the issuance of an RMA and shipping. Contact your service representative for details.

RECEIVING (CONTINUED)

RECORDING DATA PLATE INFORMATION









Locate the data plate in the workspace chamber above the inner pass box door. The data plate contains the BACTRONEZ's model number and serial number. Enter this information below for future reference.

Date Plate Information



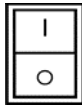



Model Number	
Serial Number	

GRAPHIC SYMBOLS

The BACTRONEZ is provided with multiple graphic symbols located on its exterior and interior surfaces. The symbols identify hazards and the functions of the adjustable components, as well as important notes found in the user manual.

Symbol	Definition
	Indicates that you should consult your service manual for further instructions. Indique que l'opérateur doit consulter le manuel d'utilisation pour y trouver les instructions complémentaires.
	Indicates Temperature Repère température
	Indicates the Over Temperature Limit system Indique le système de dépassement de température
	Indicates AC Power Repère le courant alternatif
	Indicates I/ON and O/OFF I repère de la position MARCHÉ de l'interrupteur d'alimentation O repère de la position ARRÊT de l'interrupteur d'alimentation
	Indicates protective earth ground Repère terre électrique
	Indicates UP and DOWN respectively Touches de déplacements respectifs vers le HAUT et le BA
	Indicates Manually Adjustable Indique un bouton réglable manuellement
	Indicates Potential Shock Hazard Signale danger électrique

GRAPHIC SYMBOLS (CONTINUED)

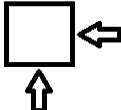
Symbol	Definition
	WEEE Directive compliant logo Indicates the unit should be recycled (Not disposed of in land-fill) Indique l'appareil doit être recyclé (Ne pas jeter dans une décharge)
	Indicates an anaerobic environment in the pass box Indique un environnement anaérobie dans le sas
	Indicates an aerobic environment in the pass box Indique un environnement aérobie dans le sas
	Indicates a injection of gas Indique un flux de gazeux
	Indicates the vacuum pump is evacuating the pass box Indique la pompe à vide se vide dans le sas
	Indicates the incubator heater is active L'élément chauffant est la production de chaleur
	Indicates the pass box doors are closed Indique les portes du sas sont fermés

INSTALLATION

AMBIENT CONDITIONS

This workstation is intended for use indoors, at room temperatures between **15°C and 30°C (59°F and 86°F)**, at no greater than **80% Relative Humidity** (at 25°C / 77°F). Allow a minimum of 4 inches (10cm) between the workstation and walls or partitions, and 2 inches (5cm) of clearance above the top of the workstation for unobstructed airflow.

Operating the unit outside of these conditions may adversely affect the unit's temperature range and stability.

For conditions outside of those listed above, please contact your distributor or Sheldon Sales to explore other unit options suited to your laboratory or production environment.

LOCATION

When selecting a location to install your BACTRONEZ, consider environmental conditions that can affect the workstation's temperature and atmospheric integrity:

- Ovens, autoclaves, and any device that produces significant radiant heat
- Heating and cooling ducts, or other sources of fast moving air currents
- High-traffic areas
- Direct sunlight

Note: Direct exposure to air conditioning vents or other sources of cold air can result in condensation or fogging on the workstation's acrylic glass panels, depending on humidity and other ambient conditions. Prolonged exposure to cold air flows may adversely affect the temperature performance of the incubator.

UV LIGHTING

Check if your laboratory or workspace contains sources of UV lighting. Sustained exposure to direct sunlight, UVC or UV germicidal lighting around 254nm, will cause a rapid aging of BACTRONEZ acrylic glass panels and arm port sleeves. Periodic use of long-wave (365nm) UV hand lamps for bacterial identification should not damage the acrylic glass. See the [Maintaining the Acrylic Glass Panels](#) entry on page 55 for more details.

INSTALLATION (CONTINUED)

HIGH ALTITUDE LOCATIONS

BACTRONEZ anaerobic workstations are equipped with two (2) digital vacuum controller - display units that control the atmospheric cycling operations of the pass box and the vacuum pump line pressure. These units are calibrated at the factory at an altitude of 179 feet (54.5m) above sea level, and read gauge pressure rather than absolute pressure. Altitudes around 6500 feet (2000m) or higher may affect the operation of the vacuum system, depending on ambient conditions. If the vacuum pump runs continuously or near continuously when installed at a high altitude location, contact [Sheldon Technical Support](#) (see page 6) for assistance in adjusting the vacuum gauge settings.

POWER SOURCE

Always position the workstation so that the users have access to the power cord and can quickly unplug it in the event of an emergency.

When choosing a location for the BACTRONEZ check that the voltage and ampere requirements on the workstation's data plate match those of your wall source. The source must be an earth grounded outlet **The supplied voltage must not vary more than 10% from the data plate rating. Damage to the workstation may result if supplied voltage varies more than 10%. Each** BACTRONEZ workstation is provided with a 110 – 120VAC 8ft (2.5m) 5-15 NEMA power cord.

These incubators are intended for a 50/60 Hz, 110 - 120 volt applications at the 9 Amps

Use a separate circuit to prevent loss of the unit due to overloading or circuit failure.

Note: Electrical supply to the BACTRONEZ must conform to all national and local electrical codes.

INSTALLATION (CONTINUED)

LIFTING AND HANDLING

The BACTRONEZ is heavy, and care should be taken to use appropriate lifting devices that are sufficiently rated for these loads. Follow these guidelines when lifting and handling the BACTRONEZ workstation:

- Lift the BACTRONEZ only from its bottom surface.
- Doors, handles, and knobs are not adequate for lifting or stabilization.
- Restrain the BACTRONEZ completely while lifting or transporting so it cannot tip.
- Remove all moving parts, such as shelf spacers and trays, and secure all doors in the closed position during transfer to prevent shifting and damage.

Note: To prevent damage when moving the BACTRONEZ, turn each of the four leveling feet completely clockwise.

LEVELING

The BACTRONEZ must be level and stable for safe operation. Each BACTRONEZ ships with four leveling feet. Insert one leveling foot into each of the four holes in the bottom corners of the workstation. Adjust each foot at each corner until the workstation stands level and solid without rocking. To raise a foot, turn it in a counterclockwise direction; to lower a foot, turn it in a clockwise direction.

INSTALLATION (CONTINUED)

GAS SOURCE



Warning: Never exceed a 5% hydrogen concentration inside the unit's chamber.

Avertissement: La concentration d'hydrogène ne doit pas dépasser 5% dans la chambre anaérobie.

The BACTRONEZ requires an anaerobic gas mixture with 5% hydrogen to drive the oxygen-capturing catalytic process in the workspace chamber. To reduce anaerobic gas consumption during pass box auto cycles, the BACTRONEZ may also be connected to a second compressed gas cylinder containing an inert gas such as, nitrogen (N₂), for use in the first two stages of the three-stage auto cycle. **Manual cycles of the pass box will only draw from the anaerobic mixed gas cylinder attached to the GAS 1 In port.**

- For a single cylinder of anaerobic mixed gas (AMG), Sheldon Manufacturing recommends 5% hydrogen (H₂), 5% Carbon Dioxide (CO₂), and 90% Nitrogen (N₂).
- If you are using a two gas anaerobic application, Sheldon recommends one cylinder of AMG gas at the above ratios, and a second cylinder of 100% Nitrogen (N₂).
- Gas regulators for BACTRONEZ applications will need to be set at 15 - 20 psi. Please see [the Pressure Unit Conversion table](#) on page 46 in the Operation Section for working with units other than Pounds per Square Inch.

Anaerobic Mixed Gas is often sold by gas suppliers under the category of **Anaerobic Incubation Mixtures** or **Biological Atmospheres**. Contact your site safety officer and review your institutional safety protocols for handling, storing, and using compressed gasses. Follow all local ordinances and national regulations regarding compressed gases in research, clinical, or production environments.

BACTRONEZ ORIENTATION

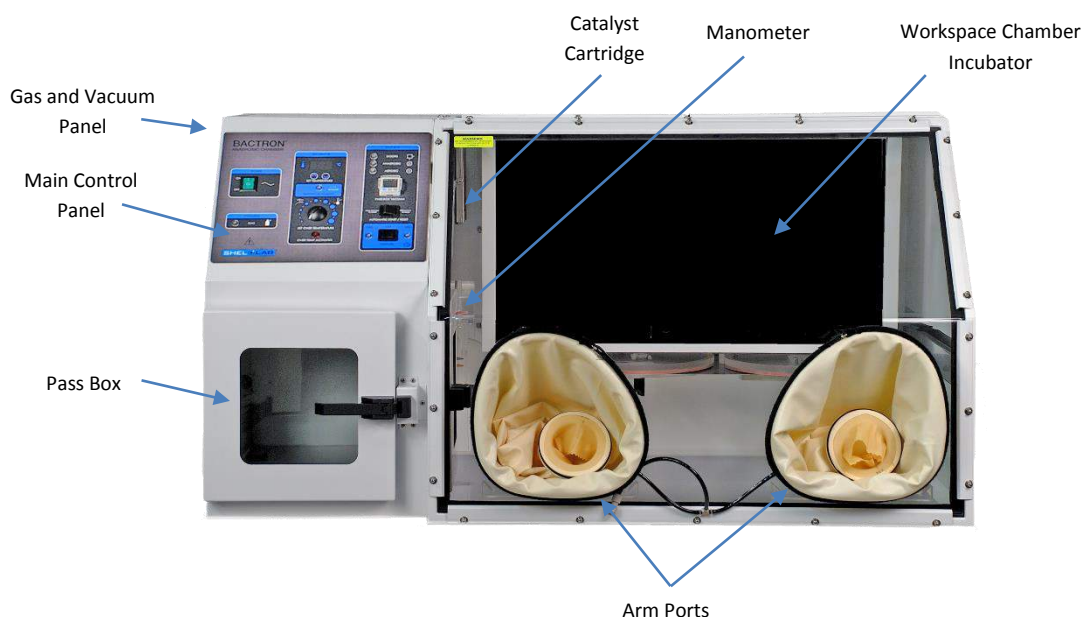

INSTALLATION (CONTINUED)

WORKSPACE CHAMBER ORIENTATION



Figure 1: Workspace Chamber Layout

PASS BOX ORIENTATION



Figure 2: Pass Box Inner Door and Sliding Shelf

The pass box is provided with an integral sliding shelf to facilitate material transfers. Small items may be introduced into the chamber via the Arm Port Doors and Sleeve Assemblies using proper sleeve technique.

INSTALLATION (CONTINUED)

CLEANING

The BACTRONEZ interior was cleaned and disinfected at the factory, but not sterilized. See the [Cleaning](#) procedure in the User Maintenance section for more information.

CONTROL PANEL OVERVIEW



Figure3: Main Control Panel

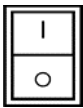

Power Switch

The main power switch on the control panel controls all power to the workstation and must be in the on (I) position before any of the BACTRONEZ's systems are powered. The switch will illuminate when on.



Chamber Gas Light

This light indicates that anaerobic mixed gas is being injected into the workspace chamber.



Main Temperature Control and Green Digital Display

This control is marked SET TEMPERATURE and consists of up and down arrow buttons for inputting a set point temperature and switching to calibration mode. The green digital display shows the incubator's temperature in its default display, accurate to within $\pm 0.1^{\circ}\text{C}$, as well as the temperature set point when the arrow keys are being used to make set point adjustments. In calibration mode, the control and display are used to enter temperature offsets to match the BACTRONEZ's displayed temperature to the temperature detected by an independent calibration (reference) thermometer.



CONTROL PANEL OVERVIEW (CONTINUED)



Heating Activated Light

The clear pilot light located beneath the label HEATING ACTIVATED illuminates whenever the heating elements are powered and warming the incubator.



Set Over Temperature

This graduated dial sets the incubator's temperature limit for the Over Temperature Limit backup system. The OTL System operates independently of the Main Temperature Control, and prevents uncontrolled heating of the incubator in the event of a failure of the Main Controller while in its heating mode. For more details, please see the explanation of the [Over Temperature Limit System](#) in the Operation section's Theory of Operation.



OTL Light

This pilot light is marked OVERTEMPERATURE ACTIVATED and is directly below the Over Temperature Limit control. The light will turn on when the OTL System has taken control of the incubator, and will be accompanied by a buzzer alarm. Under normal operating conditions this light should not illuminate.

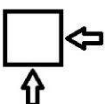

Pass Box Doors Light

The clear Doors pilot light indicates that both pass box doors are closed. This light must be on in order to cycle the pass box.



Anaerobic Light

This light activates after the completion of a full auto cycle of the pass box Interior.



Aerobic Light

This light activates when the outer pass box door has been opened, exposing the pass box to aerobic atmosphere. It remains on until the next completion of a full auto cycle.

CONTROL PANEL OVERVIEW (CONTINUED)



Pass Box Vacuum Controller and Digital Display

The main control panel vacuum gauge-controller displays the level of vacuum in inches of mercury in the pass box interior. It controls the application of vacuum to the pass box during the pass box auto cycle.

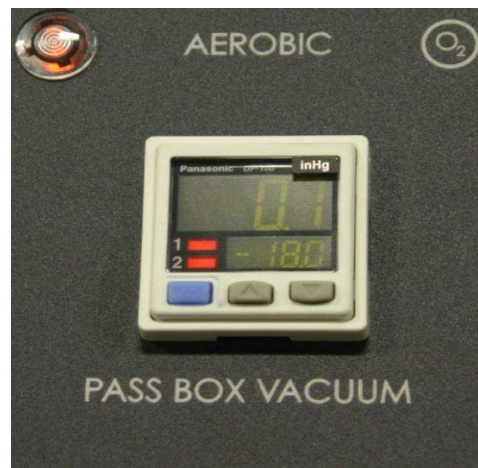

Figure 4: Pass Box Vacuum Controller and Display



Automatic Start / Reset Switch

The all black Automatic Start / Reset switch initiates or aborts the pass box's auto vacuum-and-gas-recharge cycle used to remove aerobic atmosphere from the pass box. Pressing then releasing on the left (Start) will initiate the auto cycle. Pressing and holding on the right (Reset) for three seconds will abort and then restore the pass box to a near standard atmospheric pressure sufficient that the pass box doors can be easily opened.

Pass Box Gas Light

This light indicates that the anaerobic mixed gas is being injected into the pass box during the auto cycle. The pass box Gas light **does not illuminate** during manually gas injections.

CONTROL PANEL OVERVIEW (CONTINUED)



VAC Light

The clear VAC pilot light indicates that the vacuum pump is in operation when the auto cycle is vacuuming down the pass box chamber. The Vac Light **does not turn on** during manual vacuuming.



Manual GAS / OFF / VAC Switch

The all black GAS / OFF / VAC switch allows the user to manually initiate a flow of AMG from the GAS 1 IN port into the pass box by depressing the switch to the left. Pressing the switch to the right activates the vacuum pump, lowering the atmospheric pressure inside pass box. A combination of vacuum followed by injections of anaerobic mixed gasses can be used to manually cycle the pass box.

Fuse

Located on the top back of the unit inside the cord inlet, the fuse protects against over current conditions. If the fuse blows, the unit will shut down. For your safety and the safety of laboratory personnel, the cause of a blown fuse should be determined prior to replacing it.

OPERATION

THEORY OF OPERATION AND MAJOR COMPONENT FUNCTIONS

Achieving Anaerobic Conditions

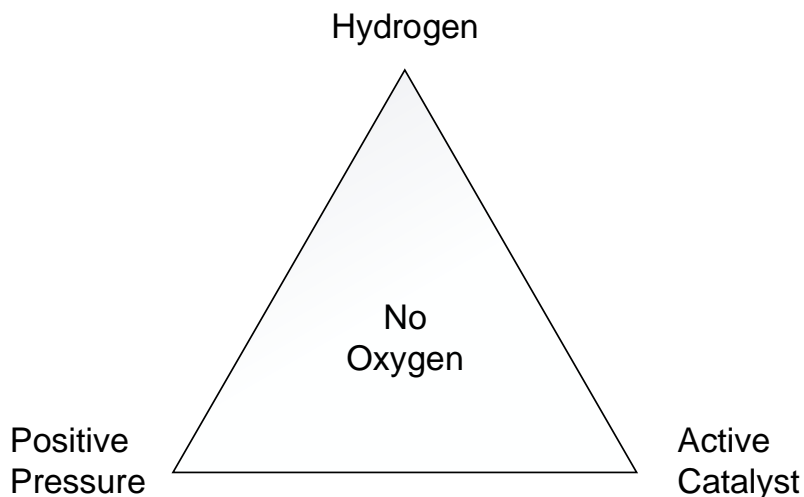

Figure 6: Atmosphere Control Measures

The BACTRONEZ workstation is designed to establish and maintain a strict anaerobic environment suitable for the cultivation of clinical anaerobic bacteria. This is achieved through injections of an anaerobic mixed gas (AMG) with a 5% hydrogen concentration, and a subsequent catalytic reaction between the hydrogen, free oxygen in the air, and the activated palladium of the workstation's catalyst scrubber. This results in the oxygen being captured in the formation of water vapor.

A palladium catalyst must be kept clean and active by baking the catalyst cartridge at 200°C after each 24 hours of usage.

A mild chamber overpressure is maintained using a workspace pressure switch sensor, AMG, and a gas injection solenoid to help prevent infiltration by outside atmosphere.

The presence of oxygen in the workstation can be detected through the use of color-changing Oxoid brand indicator strips. Microbiological controls such as, *Clostridium novyi* or *Pseudomonas aeruginosa*, may also be used to indicate anaerobic or aerobic conditions. Use of an activated charcoal scrubber in the chamber can help absorb volatile fatty acids and hydrogen sulfides generated by cultivation processes or applications.

Condensation Management

Sample media evaporation from petri dishes and water vapor from the oxygen-capturing catalytic reaction is trapped on the cold plate of a Peltier-effect condensate chiller located behind catalyst cartridge. Condensed moisture is then channeled into a drain tube that empties into a receptacle placed in the workspace chamber by the end-user. The receptacle must be drained regularly. The Peltier condensate chiller eliminates the need to use chemical desiccants to control humidity levels inside the chamber, which can retain condensate and dry out culture media.

OPERATION (CONTINUED)

Accessing the Workstation

Items such as media containers and laboratory equipment can be introduced to or removed from the BACTRONEZ's anaerobic environment through the pass box. The pass box creates a near anaerobic environment through three cyclic applications of the BACTRONEZ's vacuum pump to reduce air volume in the pass box, followed by gas replenishment injections. The pass box operates in one of two modes: A user-initiated three stage auto-cycle, or through the use of the manual control switch to lower and then recharge the atmosphere of the pass box space with anaerobic mixed gas three times. The option to manually cycle the pass box is primarily intended as a backup for the auto cycle system.

Users can access and work glove-free in the workspace chamber by donning the sleeve assemblies attached to the front panel arm ports. The sleeve assemblies are also compatible with exam gloves for handling pathogenic samples inside the workspace. After being donned – but prior to opening the arm port doors – the sleeve assemblies are cycled by using the foot pedal assembly to apply reduced pressure to the sleeves with the vacuum pump, then to charge the sleeves with AMG.

Purging, sealing, and effective use of the sleeve assemblies requires bare skin contact between the widest part of the user's forearms and the cuff ring of the sleeve assembly. Smooth, small items held in hand may be introduced into the workspace chamber through the sleeve assemblies.

Incubators

The BACTRONEZ is provided with a cabinet style incubator in the workspace chamber. The incubator's temperature is controlled by a digital controller board using a solid state temperature sensor probe attached to the incubator body and a heating element. When heating the incubator, the controller uses Proportional – Integral – Derivative (PID) analytic functions to slow the rate of heating as it approaches the user-selected set point. This is done to avoid overshooting, and to correct for naturally occurring measurement errors.

The digital controller also uses PID learning functions to optimize its warming rates for hotter or cooler environments. If the BACTRONEZ is moved to a new location with a significant temperature difference from its previous surroundings, it may require 24 hours of incubator run time for the controller to fully adapt to the new thermal environment and obtain its previous high level of temperature stability. This is why the incubator should be run at its application set point for 24 hours prior to calibration. Additionally, the heat loss from leaving the incubator doors open for long periods of time (an hour or more) can trick the controller into thinking it is operating in a cool environment. This can result in a period of temperature overshooting.

OPERATION (CONTINUED)

The Over Temperature Limit System

The OTL is a mechanical heating control backup system included with the incubator, and operates independently of the incubator's digital temperature controller board. The OTL is intended to be set to approximately 1°C above the user-selected temperature set point stored in digital controller board. The OTL prevents runaway heating in the event that the main controller fails while in its heating mode.

If the incubator's temperature exceeds to the OTL limit setting, a red pilot light indicator will illuminate and an audible alarm will buzz. The OTL System will depower the incubator's heating element, and continue to do so as long as the temperature remains higher than the OTL setting.

Manometer Pressure Gauge and Check Valve

The water-filled manometer in the workspace chamber serves as a visual pressure gauge, as well as a venting check valve during instances of excess overpressures.

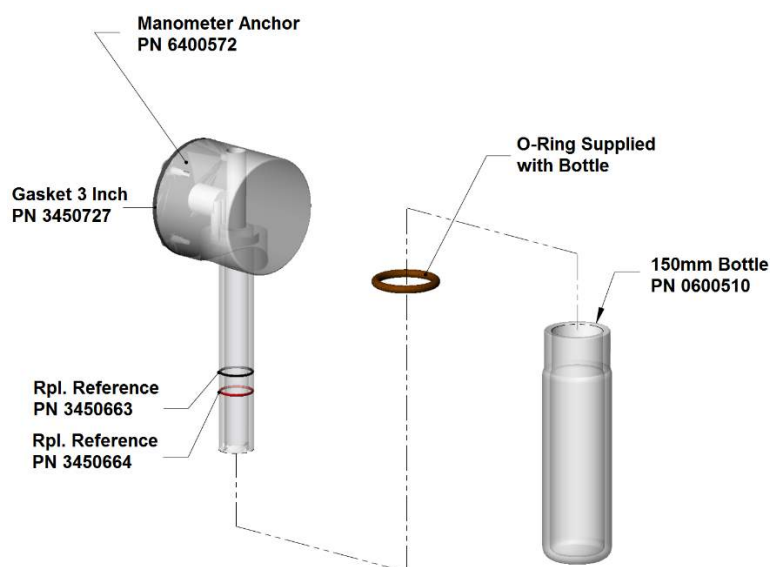

Figure 7: Manometer Components

An increase in atmospheric pressure inside the workstation drives down water within the Manometer relative to a pair of reference and refill rings. Under normal operating conditions the workstation's overpressure displaces a-half inch of water (0.5cm). Excessive pressure will cause the water to bubble as chamber atmosphere is vented through the manometer and out of the workstation. This helps prevent damage to workstation gaskets. The manometer exhaust vent is a port consisting of a transparent tube and black O-ring located on the back, right side of the BACTRONEZ.

OPERATION (CONTINUED)

SETTING UP THE BACTRONEZ

Perform the following steps to set up the BACTRONEZ workstation for use:

1. Remove all protective wrappings from accessories and the workstation.
2. Disinfect the workstation to the standards of your laboratory, clinical, or production environment protocol. The BACTRONEZ was disinfected at the factory prior to shipment. However, Sheldon Manufacturing cannot guarantee that the BACTRONEZ was not exposed to contaminants en route, or that the factory procedure matches the standards of your institutional protocols. See the **Cleaning** procedure in the User Maintenance section on page 53 for more information about cleaning and disinfecting the BACTRONEZ. Also, see step 3 of this procedure.
3. Clean, disinfect, and place the following items in the workspace chamber:
 - a. Arm port doors
 - b. The incubator bottom shelf spacers. Remove the protective shipping wrappings prior to placing the spacers in the chamber.
 - c. Any petri dish racks. These can be placed on the top shelf of the workspace chamber incubator during the setup.
 - d. At least five unopened Oxoid brand anaerobic indicator strips.
 - e. A glass flask or beaker placed under the plastic condensation tube on the left side of the chamber.
 - f. One or two 500ml beakers of purified water.
 - g. Any equipment and other aerobic-tolerant items that you plan on introducing into the workspace chamber. This saves time and AMG usage by eliminating future pass box cycles.
4. Verify that the wall power supply and incubator electrical requirements match (See the Installation Section, page 13).
5. **Do not place a catalyst cartridge in the chamber at this time!**
6. Partly open both doors of the workspace chamber incubator. **Only open the doors by approximately 1 cm (0.5 inches).** Failure to open the doors during the setup will leave reservoirs of aerobic atmosphere after the workstation's chamber space has been purged of oxygen. Opening the doors all the way at the start of the BACTRONEZ setup will cause an incubator heater to significantly overshoot its set point when the doors are finally closed.

Procedure continued on the following page



PN 9900699 / PN 9900698

Figure 8: Arm Port Doors



Figure 9: Incubator Shelf Spacers



Figure 10: Petri Dish Racks



Figure 11: Oxoid Anaerobic Indicator Strips

OPERATION (CONTINUED)

7. Perform the following procedures to setup the BACTRONEZ workstation for use.

[Setup the Gas Supply](#) page 27

[Single Gas Connection](#) or [Dual Gas Connection procedure](#) page 28

[Connecting to an In-House Vacuum System](#) or [Connect the Vacuum Pump](#) page 29

[Filling the Manometer](#) page 29

[Installing the Arm Port Doors](#) page 29

[Connecting the Foot Pedal Assembly](#) page 30

[Power the BACTRONEZ](#) page 31

[Establishing an Anaerobic Atmosphere](#) page 32

[Installing the Sleeve Assemblies](#) page 34

[Chamber Entry](#) page 35

[Verifying Anaerobic Atmosphere](#) page 35

[Exiting the Chamber](#) page 37

[Setting the Incubator Temperature](#) page 39

[Setting the Over Temperature Limit](#) page 39

OPERATION (CONTINUED)



Figure 12: Gas and Vacuum Ports

SET UP THE GAS SUPPLY

See [the Gas Source entry](#) in the Installation section on page 15 for Sheldon Manufacturing's recommended gas applications.

1. Install the gas regulator or regulators on the compressed gas cylinders you will be using.
2. The regulators should be set to 15 to 20 psi. Please see [the Pressure Unit Conversion table](#) in the Operation Section for working with units other than Pounds per Square Inch (page 46).



Figure 14: Hydrogen Warning Label



Warning: Never exceed a 5% hydrogen concentration inside the unit's chamber.

Avertissement: La concentration d'hydrogène ne doit pas dépasser 5% dans la chambre anaérobie.

Figure 13: Hose Connections

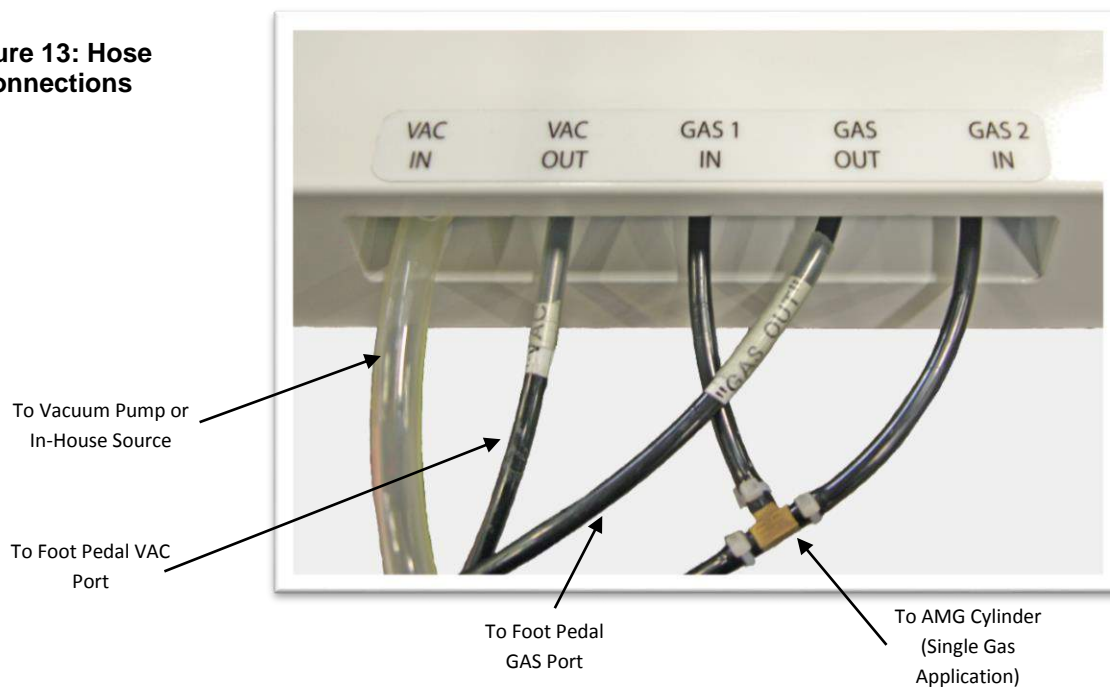

OPERATION (CONTINUED)

SINGLE GAS CONNECTION

Follow these steps to connect a single cylinder of anaerobic mixed gas.

1. Procure a T-shaped brass fitting.



Figure 14: T-Fitting AMG

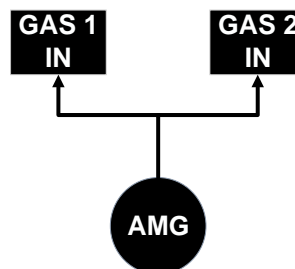

Figure 15: Single Gas Connections

2. Using attached short lengths of black OD tubing, connect the fitting to the **GAS 1 IN** and **GAS 2 IN ports** on the top left side of the BACTRONEZ. See figure 13 on the previous page.
3. Connect a barb adaptor on the T-fitting to the AMG gas regulator using the length of black OD included with the regulator.

Note: Failure to connect the T-fitting to **both** the GAS 1 and 2 ports will prevent the pass box auto cycle from purging the pass box.

DUAL GAS CONNECTION

To connect AMG and an inert recharging gas such as, nitrogen (N₂), complete the following steps:

1. Connect the AMG regulator's tubing to the BACTRONEZ's **GAS 1 IN** port.
2. Connect the inert purging gas cylinder regulator line to the BACTRONEZ's **GAS 2 IN** port.

Figure 16: Dual Gas Connections

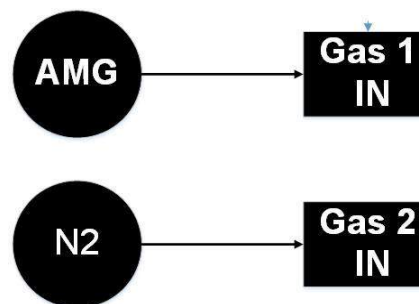

Note: When plumbed in this configuration, the BACTRONEZ will draw twice from the GAS 2 IN port, and once from the GAS 1 IN port during pass box auto cycles. This is intended to reduce pass box AMG consumption. The BACTRONEZ **will not draw** from the GAS2 IN port during manual gas injections, sleeve assembly purges, or other operations.

OPERATION (CONTINUED)

CONNECTING TO AN IN-HOUSE VACUUM SYSTEM

Carry out this procedure to connect the BACTRONEZ to an in-house vacuum system. An in-house system must be capable of evacuating a minimum of 25 inches (63.5 cm) of mercury.

1. Connect a 3/8 inch hose from the in-house system to the VAC IN port on the back, right side of the BACTRONEZ.

CONNECTING THE VACUUM PUMP

Use this procedure to connect a vacuum pump to the BACTRONEZ.

1. Connect the 3/8 inch hose from the vacuum pump to the BACTRONEZ's VAC IN port.

Note: Plug the vacuum pump into the circular grey power outlet located on the back of the BACTRONEZ at the top right. **Do not plug into a wall outlet!** Plugging the pump into a wall outlet will run the pump non-stop, rather than only when needed by the BACTRONEZ.

2. Ensure that the vacuum pump is placed in a ventilated location to prevent overheating. An overheated vacuum pump can become a fire hazard.
3. Make sure there are no kinks in the vacuum line running from the pump to the BACTRONEZ.

FILLING THE MANOMETER

1. Fill the manometer with distilled water to the refill ring (the top of the two reference rings). This can be done by unscrewing and removing the manometer bottle, or pouring water in through the hole on the top of the manometer assembly.
2. Distilled water is preferable to tap water to avoid scaling deposits from waterborne minerals.

INSTALLING THE ARM PORT DOORS

The arm port doors should already be inside the workspace chamber.



1. Turn the silver locking bar to a roughly 45° position. 
2. Install each door bottom first, inserting the tabs into the slots on the arm ports.
3. Tilt the door cover up so that it fits securely within the arm port.
4. Turn the locking bar to the horizontal position: 
5. Secure the door by turning the black arm port door knob clockwise, using wrist strength only, until the knob grabs and feels snug. Tightening too much may compromise the integrity of the door by pulling the post that the knob and locking bar are mounted on out of position.



Figure 17: Vacuum Pump



Figure 18: Manometer



PN 9900699 / PN 9900698

Figure 19: Arm Port Door

OPERATION (CONTINUED)

CONNECTING THE FOOT PEDAL ASSEMBLY

A foot pedal assembly is required to evacuate and purge the sleeve assemblies before entering the workspace chamber. Failure to cycle the sleeves prior to entry will introduce significant amounts of oxygen into the chamber. Part number 9990735

1. Place the foot pedal assembly on the floor below the arm port doors.
2. Locate the center line on the back of the foot pedal assembly.
3. Connect the branching lines from the center line's T-fitting to the two brass barb adaptor fittings on the inner sides of the arm port door assemblies. See figure below.

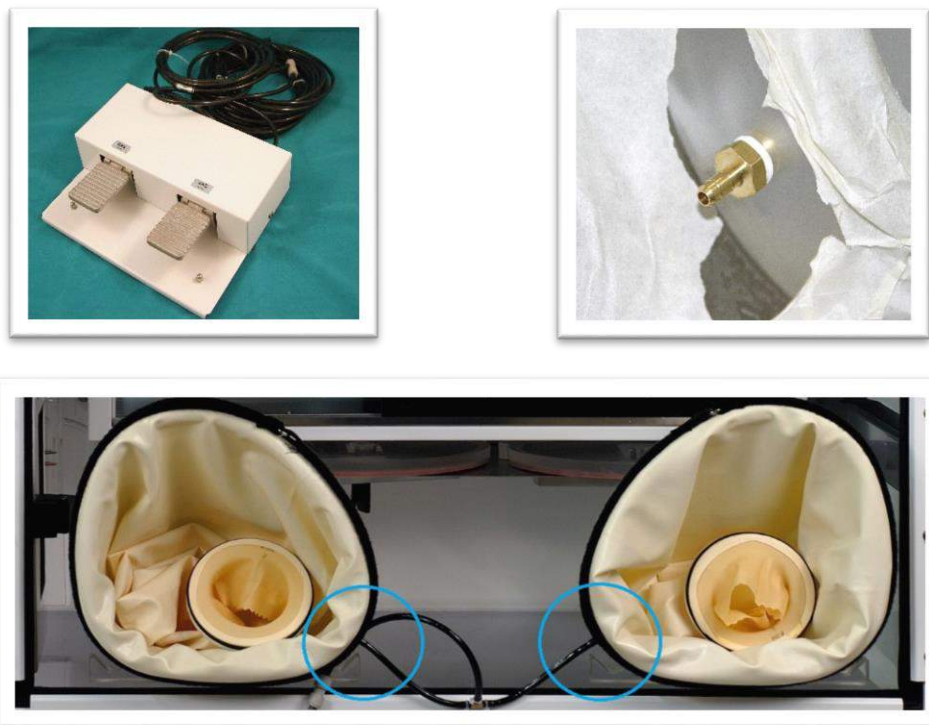

Figure 20: Foot Pedal Line Connection with the Arm Port Door Assemblies

4. Connect the line labeled VAC on the right side of the pedal assembly to the VAC OUT port on the BACTRONEZ. This supplies vacuum for reducing atmosphere in the sleeve assemblies prior to charging with AMG.

VAC → VAC OUT

5. Connect the line labeled GAS on the left side of the pedal assembly to the GAS OUT port on the BACTRONEZ. This supplies AMG for charging the sleeve assemblies.

GAS → GAS OUT

OPERATION (CONTINUED)

SHELVING INSTALLATION

Install the three (3) metal bottom shelf spacers included with the BACTRONEZ on the bottom shelf of the workspace chamber incubator. These spacers shield sample containers from direct contact with the warm surface of the incubator and ensure heat dissipation and uniformity.

1. Set the spacers on the bottom shelf of the workspace chamber incubator, side by side, with the "SPACER" label facing outwards toward you.
2. Make sure to leave the incubator doors only partly open (1cm / 0.5 inches) after installing the shelf spacers.



Figure 21: Incubator Shelf Spacer

POWER THE BACTRONEZ

1. Plug the power cord from the workstation into a suitable outlet (page 13).
2. Turn the power switch ON to verify that the workstation will power up.
3. The vacuum pump should turn on for a few seconds, and then turn off. If the pump does not run, consult Sheldon Technical Support. If the vacuum pump runs for a long period of time at higher altitudes it will require adjustment.
4. The following lights and displays should illuminate. If the lights do not illuminate, contact Sheldon Technical Support:
 - a. The Green power switch.
 - b. The Chamber Gassing pilot light will illuminate for a few seconds, if all doors are closed and the gas supply is turned on.
 - c. The Pass Box Doors sealed pilot light if the doors are closed.
 - d. The Auto Cycle Aerobic pilot light.
 - e. The green LED Set Temperature display on the main control panel.

OPERATION (CONTINUED)

ESTABLISHING AN ANAEROBIC ENVIRONMENT

Carry out the following steps to purge the aerobic atmosphere from the workstation and establish an anaerobic environment. If the BACTRONEZ has previously been in use, remove the right arm port sleeve prior to starting the procedure.

This procedure requires approximately 1 to 4 hours to complete.

1. Verify the following:
 - a. The interior and exterior pass box doors are closed and secured.
 - b. The manometer is filled to the fill line (upper ring) with water.
 - c. The foot pedal assembly center line is securely connected to the brass barb adaptors on both arm port door assemblies.
 - d. The foot pedal assembly GAS and VAC lines are connected to the GAS OUT and VAC OUT ports on the BACTRONEZ.
 - e. Gas input lines are attached to the BACTRONEZ's GAS IN 1 and GAS IN 2 ports.
2. Note the reading on the AMG gas regulator.
 - a. The BACTRONEZ workstation will require approximately 200 psi of AMG for a setup purge.
3. Make sure the AMG cylinder regulator is set to 15 to 20 psi. Open the valve all the way to start a flow of gas to the BACTRON
 - a. Nitrogen and other inert gasses **should not be used** to purge the workstation.
4. Turn on the workstation, if it is not already powered up.
5. Open the right arm port door.
6. Verify that all incubator doors are slightly open to avoid leaving reservoirs of aerobic atmosphere.
7. Unwrap and install the catalyst cartridge on the left wall inside the workspace chamber. See Figure 22 to the right.
 - a. Catalyst cartridges come ready for use from the factory. However, if you have stored the cartridge for longer than six months, it is strongly recommended that you reactivate it prior to its first use. Please see [Reactivating the Catalyst Cartridge section](#) on page 42.
 - b. The catalyst cartridge will grow warm in the presence of oxygen and AMG.



Figure 22: Catalyst Cartridge Installed

Procedure continued on next page

OPERATION (CONTINUED)

Establishing an Anaerobic Environment Continued

Note: If you have opened the left armor port door to install the catalyst, reinstall and secure the door now. Leaving the left arm port unsecured may cause AMG to “stream” through the chamber directly to the door, rather than building up and pushing out aerobic atmosphere, from the left side of the chamber to the right.

8. Reinstall the right arm port door and secure it. From the snugly tightened positioned, loosen the knob on the on the right arm port door by about half a turn. This should create a small leak that aerobic atmosphere can be pushed out through.
 - a. AMG should pulse rather than flow continually into the chamber. The Chamber Gas light should activate for 1 to 2 seconds before deactivating for 1 to 2 seconds. This will be accompanied by a clicking sound that is the gas solenoid opening and closing.
 - b. If the interval between pulses are longer than 1 to 2 seconds, or if there is no pulsing, slowly loosen the arm port knob until the interval decreases.
 - c. If gas continually pulses into the chamber, tighten right arm port door knob until an injection interval of 1 to 2 seconds is established. Continual streaming means that gas is likely streaming through the chamber directly to a door rather than accumulating and creating the turbulence necessary to purge the chamber atmosphere.
-

Note: Depending on ambient conditions (temperature of the room and humidity) there may be mild or heavy condensation on the inside of the chamber during the gas purge. This is due to the formation of water vapor during the catalytic reaction. Condensation should dissipate by the end of the purge as oxygen decreases and the condensate controller removes water vapor from the chamber atmosphere.

9. End state: When the purge process has gone through 200 psi of AMG **or** gone on for 2 hours (whichever happens first), tighten and secure the right arm port door. Then carry out the [Installing the Sleeve Assemblies](#), [Chamber Entry](#), and [Verifying Anaerobic Atmosphere](#) procedures on the following pages.

OPERATION (CONTINUED)

INSTALLING THE SLEEVE ASSEMBLIES

Prior to verifying the achievement of an anaerobic atmosphere, install the arm sleeve assemblies in order to access the chamber without introducing oxygen.

The order of the doors and the sides do not matter.

1. Unroll the large opening of a sleeve over the plastic lips of the arm port door opening. The sleeve should at least stretch to the base of the barb adaptor.
2. Secure the sleeve to the arm port using the 48 inch (121cm) self-gripping strap included with the sleeve assembly. Place the strap between the outside lip and the brass gas-and-vacuum line barb adaptor.
3. Repeat the process for the 2nd sleeve assembly and arm port.

Note: Sleeve assemblies can be left attached to the BACTRONEZ when not in use. No stowing procedure is required.



Figure 23: Mounted Sleeve Assemblies

OPERATION (CONTINUED)

CHAMBER ENTRY

Perform these steps to access and work in the workspace chamber without drawing in aerobic atmosphere. See the [Exiting the Chamber procedure](#) on page 37 for how to withdraw your arms from the chamber and sleeve assembly without compromising the anaerobic atmosphere.

1. Remove watches, bracelets, large rings, and any sharp objects that might damage the cuffs or sleeves.
2. Place your hands in the sleeve assemblies so that the cuff rings are secure around the bare skin of the widest part of your forearms.
 - a. The BACTRONEZ comes with mid-size size 8 cuff. Size 6 cuffs are available for users with smaller forearms; size 9 for larger users. Please see the Parts List on page 60.
3. Keep your hands approximately 4 – 6 inches (10 cm – 15 cm) away from the arm port doors, and slightly to either side. This helps prevent the collapsing sleeves from pulling your hands into the arm port doors during the next step.
4. Depress the VAC foot pedal (right). Both sleeves will deflate simultaneously. Continue deflating until can see the definition of your fingernails through the sleeves.
5. Flush the sleeves with AMG mixture by depressing the gas foot pedal (left). Stop as soon as you can no longer see the definition of your fingers through the sleeve, and the sleeve material does not cling to your forearms. Do not overfill the sleeves. “Ballooning” the sleeves wastes gas, and risks compromising the sleeves’ seals at the cuff rings and arm ports.
6. Repeat steps 4 and 5 for a minimum of three (3) complete evacuation and replacement cycles.
7. Loosen both arm port door knobs by two or three turns.
8. Rotate the locking bars to a roughly 45° diagonal: 
9. Slowly push one door in to the chamber, then the second. The Arm port doors can be hung in the arm port door holders on the bottom of the workspace chamber incubator.

MOVING IN THE PRESSURIZED CHAMBER

There is a minor, but noticeable feeling of resistance while working in the overpressure environment of the workspace chamber. Moving in the chamber will temporarily increase the chamber pressure. Large and fast movements can cause the manometer to bubble as anaerobic atmosphere is forced out of the BACTRONEZ. Move deliberately and steadily. Withdrawing one sleeved arm partly into the arm port while reaching in with the other (a movement combination that looks something like swimming) can help reduce pressure and gas consumption. Additionally, use of the vacuum foot pedal can help reduce any ballooning of the sleeves while working in the chamber.

OPERATION (CONTINUED)

VERIFYING AN ANAEROBIC ATMOSPHERE

This procedure verifies that an anaerobic atmosphere has been established prior to placing anaerobe samples in the workstation.

1. After entering the workspace chamber, open one (1) of the Oxoid brand anaerobic indicator strip packages.
 - a. Do not touch the indicator strip. Doing so risks contaminating the strip and creating a false positive.
 - b. For the best accuracy, and to lengthen the amount of usable time, the strip should be left in the packet, partly exposed, to avoid contamination from surfaces, and to wick oxygen detecting fluid from bottom of the packet.
 - c. Bending the edges or partly folding the packet will allow it to stand upright.
 - d. Once an indicator strip has dried out, it can no longer indicate the presence of oxygen.
 - e. There should be one, opened, moist anaerobic indicator strip in the workspace chamber at all times while maintaining anaerobic conditions. Place the strip where it will be clearly visible.
2. If the strip remains white, the chamber atmosphere is free of oxygen and ready to use. Exit the chamber using the steps described in the [Exiting the Chamber procedure](#) on page 37.
3. If the strip turns partly or completely pink, exit the chamber using the [Exiting the Chamber procedure](#) steps to avoid introducing more oxygen into the chamber.
 - a. Loosen the right arm port door to create a slight leak that aerobic atmosphere can be expelled through. See Step 11 of the [Establish an Anaerobic Environment procedure](#) on page 33.
 - b. Flush an additional 50 psi or 30 minutes worth of AMG through the chamber.

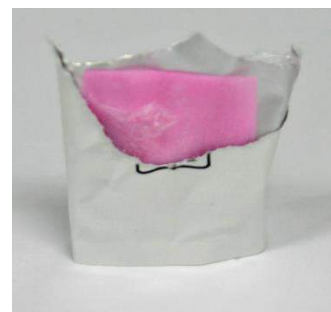

Figure 23: Pink indicating the presence of oxygen in an office environment

Note: The sleeve assemblies can be left on the BACTRONEZ during this second purge.

- c. When 30 minutes has elapsed **or** 50 psi of AMG have been flushed through the chamber (whichever comes first), re-enter the chamber using correct entry procedures, and open a second anaerobic indicator strip.
- d. If the second anaerobic indicator strip shows less pink than before, repeat steps b and c to finish purging the chamber.
- e. If the second strip turns completely pink or shows the same degree of coloring as the first, contact [Sheldon Technical Support](#) for assistance. See page 6. Also, see the optional troubleshooting procedure on the next page for steps to identify possible sources of oxygen in the work station.

OPERATION (CONTINUED)

TROUBLESHOOTING THE PRESENCE OF OXYGEN

1. Verify that proper sleeve donning, entry, and exiting procedures have been used.
2. Check if closed containers are being introduced through the pass box. Closed containers can hold significant volumes of oxygen.
3. Seek to reduce amount of daily pass box usage.
4. Make sure that the arm port doors and sleeve assemblies are correctly installed.
5. Verify that the manometer is filled to the fill line with water.
6. Verify that gas input lines are attached to the BACTRONEZ's GAS IN 1 and GAS IN 2 ports.
7. Make sure the foot pedal assembly center GAS / VAC line is securely connected to the brass barb adaptors on both arm ports.
8. Check that the foot pedal assembly GAS and VAC lines are connected to the GAS OUT and VAC OUT ports on the BACTRONEZ.
9. Turn the AMG cylinder regulator to 20 psi.
10. Uninstall the catalyst cartridge. If the cartridge is not warm, it may not be active, or it has not been exposed to AMG and oxygen. Replace it with a second catalyst cartridge (Part Number 9990759). Reactivate the first cartridge. Please see the [Reactivating the Catalyst](#) procedure on page 42.

Note: Use caution when uninstalling the catalyst cartridge. The catalyst may have grown hot during the purge procedure.

11. Make sure that the anaerobic indicator strip packets have not been opened prior to being placed in the oxygen-free atmosphere of the chamber.

OPERATION (CONTINUED)

EXITING THE CHAMBER

The following steps are used to exit the chamber without pulling in aerobic atmosphere.

1. Check that the exterior and interior pass box doors are both closed and secured, to avoid drawing aerobic atmosphere through the pass box.
2. Depress the GAS foot pedal (left) for one or two seconds. Charging the sleeves with gas will help prevent them from constricting while withdrawing from the chamber.
3. Grasp the arm port doors by the silver locking bars, and slowly withdraw one arm, then the other. Inset the tabs on the doors into the slots of the arm port assembly. Then tilt the doors toward you so that they sit securely in the ports. Rotate both locking bars from the diagonal to horizontal position.
4. Tighten the arm port door knobs until the knobs start to grab, using wrist strength only.
5. Withdraw both hands from the cuffs. Exit the sleeves.

Door Check

6. Grasp both sleeves tightly, approximately three (3) to four (4) inches (7 – 10cm) behind the cuffs.
7. Gently and slowly push both sleeves towards the doors. This will cause the sleeves to balloon up.
8. This creates pressure in the sleeves. If the manometer bubbles in response, the doors are not sealed.

Note: Never physically press on the arm port doors to test the seal! Doing so, especially doing so repeatedly, may warp front panel or damage the doors.

9. If the manometer bubbles, reenter the sleeves, and re-secure both arm port doors.
10. When the arm port doors are sealed, slowly withdraw both arms from the sleeves.



Figure 24: Securing the Arm Port Doors

OPERATION (CONTINUED)

SETTING THE INCUBATOR TEMPERATURE

1. Using a coin or other flat metal implement, turn the **Over Temperature Limit** control dial clockwise to the maximum position indicated by the largest dot. This prevents the Over Temperature Limit System from interfering with setting a new temperature for the incubator.
2. Press either the **Up** or **Down** key one time on the Temperature Control sub-panel to activate the temperature set point mode.
3. The Set Temperature digital display will briefly display the letters “SP” for Set Point. The display will then go from bright to dim, and start to blink. The display will now show an adjustable temperature set point.
4. Use the **Up** or the **Down Arrow keys** to adjust the set point to the temperature you want the incubator to run at.
5. If neither key is pressed within 5 seconds, the Set Temperature display stops blinking and returns to displaying the current temperature of the incubator.
6. After selecting your set point, wait 5 seconds. The display will stop flashing, and the set point is now saved in the temperature controller. The incubator will now adjust to match your set point.
7. Set the Over Temperature Limit System, using the procedure below.

Note: Sheldon Manufacturing recommends waiting for 24 hours for the incubator temperature to stabilize prior to loading samples.

SETTING THE OVER TEMPERATURE LIMIT

Perform the following steps to set up the Over Temperature Limit system for use.

1. If you have not done so already, turn the Set Over Temperature Limit control dial clockwise to the maximum position. This allows the Set Temperature control to stabilize.
2. Turn the Over Temperature Limit control dial counterclockwise until the Over Temp Limit Activated light illuminates and the audible alarm buzzes.
3. Slowly turn the Over Temperature Limit control dial clockwise until the light and audible alarm turn off.
4. This adjusts the Over Temperature Limit control to approximately 1°C above the temperature configured by the Set Temperature control.

Note: The Over Temperature Limit System will activate if the incubator temperature exceeds the temperature setting of the OTL System. If the main temperature controller system has failed, or the OTL is set below your chosen temperature set point, the OTL alarm will buzz and continue to turn on and off indefinitely. Contact [Sheldon Technical Support](#). See page 6.

OPERATION (CONTINUED)

OPERATING THE PASS BOX

The pass box is used to introduce items into or remove items from the workspace chamber.

Automatic Cycle

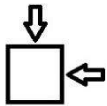

1. Make sure the inner pass box door is closed and secured.
2. Open the outer pass box door. If not already on, the Pass Box Aerobic light will illuminate, indicating that the pass box has been exposed to the aerobic atmosphere of the room.
3. Load the pass box slider shelf with items to be introduced in the workspace chamber.
4. Close and secure the outer door. The Pass Box Doors light will then illuminate. The light will only do so when both the inner and outer doors are closed. **The Doors light must be on for the auto cycle to initiate.**

Note: Contact Sheldon Technical support if the Air Lock Doors light will not illuminate when both doors are closed and secured.

5. Briefly depress the Auto Cycle Start / Reset Switch to the left to initiate the auto cycle.
6. The Aerobic and Anaerobic indicator lights will alternately flash on and off, indicating that a cycle is in process. The vacuum pump will cycle the air pressure inside the pass box three times (from -18 inHg to -4 inHg), refilling twice from the GAS2 IN port, and on the final cycle from the GAS1 IN port.
7. The anaerobic light will illuminate once the cycle has finished. The inner pass box door may now be opened, and items introduced into the workspace chamber.
8. Do not open the outer pass box door while the inner pass box door is opened!
9. After removing items from the slider shelf, return it to the pass box chamber. Close the inner pass box door. This safeguards against inadvertently introducing oxygen into the workspace chamber if someone opens the outer door later on.



Vacuum Interruption: The Chamber Gas light illuminates when the BACTRONEZ is injecting AMG into the workspace chamber. Chamber injections are made in response to the workspace atmospheric pressure falling below a factory-set threshold. If the light illuminates while the vacuum pump is active, the BACTRONEZ will briefly depower the vacuum pump. If the Chamber Gas light illuminates frequently during auto cycle, abort the cycle (see below). There may be a leak along the inner pass box door, which is allowing the pass box to pull atmosphere out of the workspace chamber and into the vacuum lines. Contact Sheldon Technical support.



Aborting: To abort the automatic cycle, depress and hold the Auto Cycle Start / Reset switch to the right for **three (3) seconds**. The BACTRONEZ will cease vacuuming and automatically restore pressure to the pass box. The vacuum gauge must rise to at least -2 inHg (near room pressure) before the Pass Box Aerobic and Anaerobic lights will stop flashing, and the inner pass box door can be opened.

OPERATION (CONTINUED)

Manual Cycle

The manual cycle is intended as a backup for use in the event the auto cycle is not functioning.



1. Verify that the inner pass box door is closed and secured.
2. Open the outer pass box door. The Pass Box Aerobic Light will illuminate, indicating that the pass box chamber has been exposed to the aerobic atmosphere of the room.
3. Load the pass box slider shelf with items to be introduced into the workspace chamber.
4. Close and secure the outer door. The Pass Box Doors light will illuminate when both doors are closed. **Do not manually cycle the pass box if the Pass Box Doors light is not illuminated!**

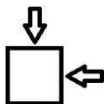

Note: Contact Sheldon Technical support if the Air Lock Doors light will not illuminate when both doors are closed and secured.



5. Depress the Manual Gas – OFF – VAC switch to the right (VAC). Hold the switch down until the vacuum gauge display shows -17 inHG to -20 inHg of air pressure in the pass box.

Note: If the Chamber Gas light illuminates frequently and disrupts operation of the vacuum pump while vacuuming down the chamber, release the Manual Gas – Off – Vac switch. Immediately cease vacuuming if the water in the manometer gauge begins to bubble. In both cases there may be a leak along the inner pass box door. Continuing to vacuum may seriously damage the BACTRON. Contact Sheldon Technical Support for assistance.



6. Depress the Manual Gas – OFF – VAC switch to the left (GAS) to inject AMG into the pass box. Hold the switch until the vacuum gauge display reads approximately -4 inHg. This completes one sub-cycle. Note that manual injections only draw from the GAS 1 IN port.
7. Repeat step 5 twice more. On the third and final cycle, hold the Manual – Gas – Off switch to the left until the vacuum gauge display reads 0. The pass box has now been restored to the room's atmospheric pressure, and the pass box interior door can now be opened.
8. The Anaerobic indicator light **will not** illuminate following the completion of a manual cycle. It only illuminates after an auto cycle is fully completed.
9. Do not open the outer pass box door while the inner pass box door is opened!
10. After removing items from the slider shelf, return it to the pass box chamber. Close the inner pass box door. This safeguards against inadvertently introducing oxygen into the workspace chamber if someone opens the outer door later on.

Note: Failure to cycle the pass box three times to the standards described above risks allowing aerobic atmosphere into the workspace chamber.

OPERATION (CONTINUED)

LOADING THE WORKSTATION

Sheldon Manufacturing recommends waiting 24 hours after establishing an anaerobic atmosphere before loading samples into the unit.

Airtight containers can introduce significant amounts of oxygen into the anaerobic environment of the BACTRONEZ. Whenever possible, closed containers placed in the pass box should be loose-capped or ventilated to allow the pass box cycles to draw oxygen from the containers. Syringes should be loosened and sealed containers partly opened, if permitted by your laboratory or production protocol.

The pass box sliding shelf can hold and transport up to 90 plates. Place samples and other media containers on the shelves inside each incubator as evenly spaced as possible. Good spacing allows for atmosphere circulation and a higher degree of temperature uniformity. If the anaerobes sensitive to heat are being cultivated, it may be necessary to place an empty petri dish or plate at the bottom of each stack.

This concludes the Setting up the BACTRONEZ portion of the Operation Section.

REACTIVATING THE CATALYST CARTRIDGE

An active catalyst cartridge must be installed to maintain anaerobic conditions. A spare cartridge should be purchased so that cartridges can be swapped out for reactivation. For optimum performance, reactivate a catalyst cartridge after every 24 hours of use. To reactivate a cartridge, perform the following:

1. Heat the catalyst cartridge at 200°C overnight prior to installing in the BACTRONEZ.
 - a. The handle of the cartridge can be removed prior to heating, and reinstalled afterwards. Use appropriate Personal Protective Equipment (PPE) to prevent burns.
2. A quality control test should be performed on each cartridge once per month.

Note: A flow of AMG for testing can be obtained by disconnecting the foot pedal gas / vacuum line from an arm port while the door is closed, and then depressing the Gas pedal.

- a. Flow anaerobic mixed gas with hydrogen over a reactivated catalyst cartridge in a normal aerobic atmosphere. Or place the reactivated catalyst cartridge in the pass box and run a full auto cycle.
- b. The palladium coated pellets inside the catalyst cartridge should grow warm in the presence of oxygen and hydrogen, indicating that cartridge is ready for use.
- c. If the cartridge does not heat up when exposed to AMG and oxygen, reheat to 200°C. While the cartridge is still hot, flow AMG over the cartridge in an oxygen environment. This should help remove any buildup of hydrogen sulfides or other contaminants that might interfere with the cartridge's effectiveness.
- d. Test the room temperature reactivated cartridge again with another flow of AMG in an aerobic environment.

OPERATION (CONTINUED)

CALIBRATE THE INCUBATOR TEMPERATURE DISPLAY

Temperature calibrations are performed to ensure that the control panel temperature display matches the actual temperature inside a BACTRONEZ incubator. Each BACTRONEZ incubator is calibrated at the factory to 37°C. Calibrate as often as required by your laboratory or production protocols, or regulatory requirements.

Allow the incubator at least 24 hours to stabilize heated at its operational set point, with the incubator doors closed, before performing a calibration. Always use a certified temperature sensing reference device that is regularly calibrated to 0.1°C by an independent party to conduct temperature verifications or calibrations. For best results use a remote sensing device.

1. Place the temperature sensor of a calibrated reference device inside the incubator as close as possible to the chamber's geometric center. Check that the sensor is not in direct contact with the shelving.

Note: A thermocouple sensor probe's sleeve may be taped to the shelving, as long as the exposed copper end is 2 inches (5cm) above the shelf. An exposed sensor probe in direct contact with the shelving may experience heat sinking, which can result in an inaccurate temperature reading.

2. Allow the temperature to re-stabilize after closing the door.
 - a. The reference device's temperature measurement should not change for at least one (1) hour after a significant disruption for the chamber to be considered stabilized.
3. If the reference device's and the incubator's temperature readings are the same, or the difference between the two falls within the acceptable range of your laboratory protocol after one (1) hour of stability, **the incubator is calibrated**.
4. If there is a difference between the two (2) readings, and that offset falls outside your laboratory protocol's acceptable range, adjust the incubator's temperature display to match the reference device's reading. **See the next step**.
 - a. If the door was **briefly** opened for a few seconds to take a reading, wait fifteen minutes for the temperature to stabilize before correcting for the offset. If the opening was longer, wait one (1) hour for the temperature to stabilize.
5. Press and hold both the **UP** and **DOWN** arrows simultaneously. The Temperature Display of most models will flash the letters "CO" when the controller enters calibration mode.
6. The display will continue flashing and display the **current temperature value**. Adjust the **current value** until it matches the reference device's temperature reading.
7. After matching the unit's current value to that of the reference device, wait five seconds. The incubator's Temperature Display will cease flashing, and the incubator will begin adjusting to compensate for the entered temperature offset.

Procedure continued on next page

OPERATION (CONTINUED)

8. Allow the incubator a minimum of four (4) hour to stabilize after reaching the new temperature.
9. Compare the reference device's reading with the incubator's. If the reference device's and the incubator's temperature readings are the same or fall within the range of your laboratory protocol, the incubator is now calibrated.
10. If the two readings still fall outside your laboratory protocol, repeat steps 5 – 8.
11. If the temperature readings of the incubator and the reference device fall outside your laboratory protocol after three calibration attempts, contact [Sheldon Technical Support](#) for assistance.

GAS CONSERVATION METHODS

1. Minimize the number of times per day the pass box is cycled.
2. Introduce small individual items such as, sealed micro plates or transport tubes, into the workspace chamber through the sleeve assemblies.
3. Moving a large number of items through the pass box in one transport will reduce the volume of AMG used in an auto or manual cycle.
4. When transporting a small number of items through the pass box, placing a large solid object in the pass box can also help to reduce the volume of gas utilized.
5. Employ proper sleeve techniques when entering and exiting the workspace chamber.
6. Avoid making fast or large movements while working in the chamber. Use a swimming motion, withdrawing one arm partly into the arm port while reaching in with the other.

OPERATION (CONTINUED)

ACTIVATED CHARCOAL SCRUBBER AND REJUVENATION CYCLE

An activated charcoal scrubber can be placed in the workspace chamber to absorb volatile fatty acids (VFAs) or volatile sulfur compounds (VSCs) produced by sample cultivation. This helps keep the workstation interior clean and maintain catalyst endurance when running cultivation processes or applications that produce large amounts of VFAs or VSCs. See the [Accessories section](#) on page 62 for Sheldon Manufacturing's recommended charcoal scrubber and Anatox fan scrubber unit.

1. Recommended use is 250 grams (one packet) placed in a 500ml beaker inside the chamber. Place another 250 grams into a second 500ml beaker.
2. On day 2 replace the first beaker of charcoal scrubber with the second.
3. On day 3 rejuvenate the first beaker of charcoal scrubber by heating at a minimum of 160°C for at least two (2) hours). Place the rejuvenated scrubber in the chamber. Remove and rejuvenate the second scrubber. For best effect, rejuvenate the scrubber overnight.
4. Repeat this cycle for six (6) months. Discard the old scrubbers after six months and replace.

ATTACHING EQUIPMENT TO THE CHAMBER ACCESSORY OUTLETS

BACTRONEZ workstations are provided with two 1 amp accessory outlets located inside the workspace chamber, on the left internal wall. The power switch on the main control panel controls power to the accessory outlets. The outlets can power equipment such as magnetic stirrers, an Anatox activated charcoal scrubber fan, etc. Do not attach equipment drawing more than one (1) amp.

Accessory equipment may produce additional heat in the workspace chamber. This can affect the temperature range of the incubator. Monitor the chamber pressure and incubator performance when using powered accessories inside the workspace chamber.

OPERATION (CONTINUED)

DEIONIZED AND DISTILLED WATER

Note: Do not use deionized water for cleaning or humidifying your workstation.

Use of deionized water may corrode metal surfaces and will void your warranty. Sheldon Manufacturing recommends the use of distilled water in the resistance range of 50K Ohm/cm to 1M Ohm/cm, or a conductivity range of 20.0 uS/cm to 1.0 uS/cm, for cleaning and humidifying applications.

HUMIDIFYING THE INCUBATOR

Placing a small number of petri dishes or open media containers in the BACTRONEZ for several weeks may lead to excessive drying of sample media. A small open container such as, a flask, of 500ml of distilled water, set on each shelf can help to slow sample drying.

PRESSURE UNIT CONVERSION

Conversion table for pressure units								
	kPa	MPa	kgf/cm ²	bar	psi	mmHg (Torr)	inHg	atm
1 kPa	1	1×10^{-3}	1.01972×10^{-2}	1×10^{-2}	1.45038×10^{-1}	7.50062	0.2953	9.86923×10^{-3}
1 MPa	1×10^3	1	1.01972×10	1×10	1.45038×10^2	7.50062×10^3	0.2953×10^3	9.86923
1 kgf/cm ²	9.80665×10	9.80665×10^{-2}	1	9.80665×10^{-1}	1.42234×10	7.35559×10^2	2.8959×10	9.67841×10^{-1}
1 bar	1×10^2	1×10^{-1}	1.01972	1	1.45038×10	7.50062×10^2	2.953×10	9.86923×10^{-1}
1 psi	6.89473	6.89473×10^{-3}	7.03065×10^{-2}	6.89473×10^{-2}	1	5.17147×10	2.036	6.80457×10^{-2}
1 mmHg (1 Torr)	1.33322×10^{-1}	1.33322×10^{-4}	1.35951×10^{-3}	1.33322×10^{-3}	1.93368×10^{-2}	1	3.9370×10^{-2}	1.31579×10^{-3}
1 inHg	3.3864	3.3864×10^{-3}	3.4531×10^{-2}	3.3864×10^{-2}	0.4912	2.5400×10	1	3.342×10^{-2}
1 atm	1.01325×10^2	1.01325×10^{-1}	1.03323	1.01325	1.46960×10	7.60000×10^2	2.9921×10	1

Figure 25: Pressure Measurement Unit Conversions

USER MAINTENANCE

Chamber Quality Control Check Sheet

Month:	Temperature	Catalyst Changed	Condensate Drained	Cylinder Pressure Reading	Indicator Strip Changed
Date:					
1					
2					
3					
4					
5					
6					
7					
8					
9					
10					
11					
12					
13					
14					
15					
16					
17					
18					
19					
20					
21					
22					
23					
24					
25					
26					
27					
28					
29					
30					
31					

You may copy this sheet for institutional use

USER MAINTENANCE (CONTINUED)

DAILY MAINTENANCE

1. Exchange the catalyst cartridge with a reactivated one.
2. Remove and empty the condensate collection container as needed.
3. Change the anaerobic indicator strip at least once per 24 hours, or as often as necessary so that the indicating strip in the workspace chamber remains moist.
4. Visually inspect that the pass box gaskets are properly seated.
5. Check the cuffs on the sleeve system for holes, tears, and other signs of wear that may compromise integrity. Replace if necessary.
6. Check the incubator temperature to ensure that the setting is correct.
7. Record the gas cylinder reading(s).
8. Change or rejuvenate the charcoal scrubber, if installed. Please see the [Activated Charcoal Scrubber and Rejuvenation Cycle](#) on page 45 in the Operation section.
9. Clean and disinfect the workspace chamber after each use, or in accordance with your laboratory or production protocols, or regulatory requirements.

NORMAL GAS CONSUMPTION

A sealed BACTRONEZ workstation will typically go for more than 30 minutes between gas injections into the workspace chamber. When injecting, the Chamber Gas pilot light will illuminate, accompanied by a pair of audible clicks from the activated gas solenoid.

The manometer water column should be depressed by approximately half an inch (1 cm) under normal operating conditions.

Injections taking place every thirty minutes or less **may** indicate a small leak. Injections every 10 – 30 seconds are indicative of a large leak.

Note: Pass box cycles, entering or exiting the arm port doors, or working within the workspace chamber may temporarily increase the frequency of gas injections.

USER MAINTENANCE (CONTINUED)

LEAK DIAGNOSIS – UNIT FULL

Perform this leak check procedure for a unit that is in use and that cannot be powered off or otherwise taken out of operation.

1. Read the **Normal Gas Consumption** section on the previous page prior to performing a leak diagnosis.
2. Record the gas cylinder gauge level at the end of the workday. Note the gauge level next morning. This is done to help establish a loss level for while the BACTRONEZ is undisturbed. In other words, when no one is working in it.
3. Review the gas level entry in the BACTRONEZ's maintenance log. For periods of high gas consumption, check if lab personnel are accessing the unit through the pass box and arm port doors with greater frequency. Accessing increases gas usage.
4. Make sure the inner pass box door is being closed after all sample transfers are complete.
5. The pass box Doors light should illuminate when both doors are closed. If the light does not activate, check that both doors are sealed. The pass box doors should sit flush against the door gaskets.
6. Check the integrity of the door gaskets. There should be no brittleness or dryness, and no cracks. Check that both gaskets are evenly and securely seated on the mounting frames. If sticky sample media has been spilled on the interior surfaces of a pass box door, the door may be pulling off the gasket whenever it is opened.
7. Verify that manometer is filled up to the refill (top) ring with water.
8. Check that the arm port doors are secure when not in use. The locking bars should be in the horizontal position, and the knobs tightened clockwise using wrist strength. Check the door ring seals for signs of damage or excessive wear.
9. Check that the water level of the manometer is pushed down by approximately half an inch (1 cm). If the manometer is filled and the water level is not depressed, the system is either not injecting gas or there is a significant leak.
10. If there is a gas leak, the Chamber Gas light will turn on and off frequently. This will be accompanied by a "clicking" sound that is the chamber gas solenoid injecting gas into the chamber.
11. A gas leak detector capable of detecting hydrogen (Part Number 4600501) can be used to find leaks along the edges of acrylic glass front panel, arm port doors, outer airlock door, and back panel.



Note: Some hydrogen gas will naturally diffuse through the water-filled manometer. If you are using a handheld hydrogen gas detector, the manometer exhaust port on the back of the BACTRONEZ will register as a leak under normal operating conditions. **Do not seal or otherwise obstruct the manometer exhaust port.** Doing so will compromise the unit's pressure management and gas regulation systems, and void your warranty.

12. Contact your institutional maintenance department or Sheldon Technical Support for assistance if a leak is confirmed, or if heightened gas consumption is not restricted to periods of increased access and use.

USER MAINTENANCE (CONTINUED)

LEAK CHECK – EMPTY UNIT

Use this procedure to verify the atmospheric integrity of a BACTRONEZ that is not in use, or that can be taken out of operation. Read the **Normal Gas Consumption** section on page 48 prior to performing a leak check.

1. Remove the catalyst cartridge from the BACTRONEZ. The catalytic production of water vapor reduces the volume of atmosphere in the chamber, and will interfere with performing an accurate leak check.
2. Make sure the BACTRONEZ's incubator is either off and at room temperature, or heated at and stabilized at the its application set point. An incubator that is actively heating from ambient temperature to reach a set point creates increased air pressure in the workstation from atmospheric thermal expansion.

Note: The workstation should be at a steady temperature and atmospheric pressure state when performing a leak check.

3. Close and secure the outer and inner pass box doors.
4. Verify that manometer is filled up to the refill (top) ring with water.
5. Check that the arm port doors are secure, with the locking bars in the horizontal position, and the knobs tightened clockwise using wrist strength. Check the door ring seals for signs of damage or wear.
6. Check that the gas regulator is set to 15 to 20 psi. Open the gas cylinder valve all the way on if not already opened. Turn the power switch on if the workstation is turned off. Check that the Chamber Gas light illuminates.
7. The pass box doors light should illuminate, indicating that both doors are closed. If the light does not activate, check that both doors are sealed.
 - a. The pass box doors should sit flush against the surrounding body of the workstation.
 - b. Check the integrity of the door gaskets. There should be no brittleness or dryness, and no cracks.
8. Check that the water level of the manometer is pushed down by approximately half an inch (1 cm). If the manometer is filled, the BACTRONEZ is powered and injecting, and the water level is not depressed, the system is either not injecting gas or there is a significant leak.
9. If there is a gas leak, the Chamber Gas light will turn on and off frequently. This will be accompanied by a "clicking" sound that is the gas solenoid injecting gas into the chamber. Record the frequency of injections.
10. If there are no leaks in the system, the Chamber Gas light will remain OFF, and the water level in the manometer will remain stable at approximately 05. Inches (1 cm) of displacement.

Procedure continued on next page

USER MAINTENANCE (CONTINUED)

11. A gas leak detector capable of detecting hydrogen (Part Number 4600501) can be used to find leaks along the edges of acrylic glass front panel, arm port doors, outer airlock door, and back panel.



Note: Some hydrogen gas will naturally diffuse through the water-filled manometer. If you are using a handheld hydrogen gas detector, the manometer exhaust port on the back of the BACTRONEZ will register as a leak under normal operating conditions. **Do not seal or otherwise obstruct the manometer exhaust port.** Doing so will compromise the unit's pressure management and gas regulation systems, and void your warranty.

12. If the arm port doors and pass box doors are secure, and the leak persists contact your institutional maintenance or Sheldon Technical Support for assistance.

DOOR GASKET MAINTENANCE AND USAGE

BACTRONEZ door gaskets are subject to significant compression during pass box cycles. Users cycling the pass box more than fifteen times per day will need to replace the door gaskets every three (3) to six (6) months. Heavy institutional users may wish to keep a pair of spare door gaskets on hand (Part Number 3450506).

Spilling sample media on door gaskets or the interior surfaces of pass box doors may cause the gaskets to stick to the doors. This can compromise the atmospheric integrity of the pass box. The gaskets can be cleaned with dish soap and warm water, if your laboratory or production protocol permits.

SLEEVES MAINTENANCE AND USAGE

Sleeves may be washed with dish soap and warm water between uses. Disinfection should be carried out per lab or production protocols. Institutions with several users for each BACTRONEZ may wish to keep a pair of sleeves in small, medium, and large sizes on hand. Or keep a pair of sleeves for each user.

USER MAINTENANCE (CONTINUED)

REPLACING THE SLEEVE CUFFS

A sleeve cuff should be replaced if it shows signs of brittleness or dryness, or if cracks are visible.

Standard Sleeve Cuff (4 Inches / 10cm)

1. Remove the sleeve cuff by performing the following.
 - a. Remove the black O-ring located on the outside of the sleeve assembly, around the cuff. Gently roll the ring off to avoid damaging it or the sleeve.
 - b. Slowly and gently remove the sleeve-cuff and its sleeve cuff-ring from the sleeve.
 - c. Remove the second (2nd) black O-ring, which holds the sleeve-cuff to the cuff-ring.
 - d. Remove the old sleeve-cuff from the cuff-ring and discard. Inspect the cuff-ring. Replace the cuff-ring if there are cracks, dryness, brittleness, or a loss of flexibility.
 - e. Inspect the black O-rings. Replace if cracks, dryness, brittleness, or a loss of flexibility are present.
 - f. Inspect the sleeve. Replace if cracks, dryness, or brittleness are present.

2. Replace the sleeve-cuff.

- a. Pull a new sleeve-cuff on over the cuff-ring.
- b. Pull an O-ring onto the cuff-ring, over the sleeve-cuff. Fit the ring into the groove opposite the cuff's fringed side.
- c. Pull the lip of the sleeve over the sleeve-cuff and cuff-ring. The cuff's fringed end should be left outside the sleeve.
- d. Pull on the second O-ring. Fit the O-ring into the groove on the outside of the sleeve and sleeve cuff. This is the unoccupied cuff-ring groove.

End of procedure

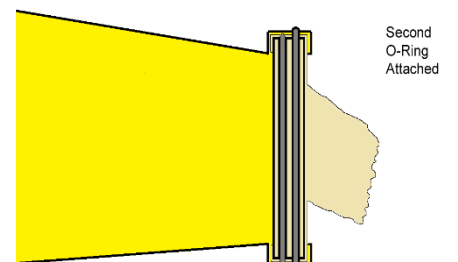
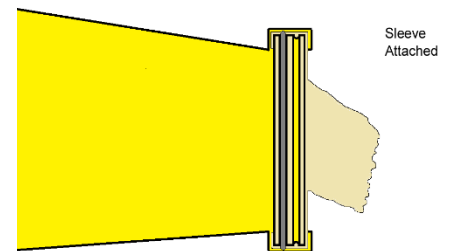
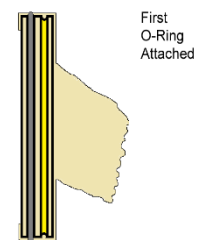
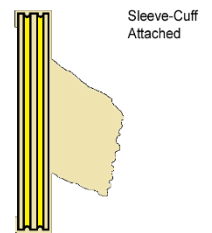
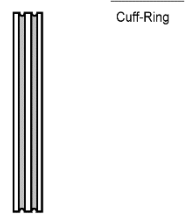

USER MAINTENANCE (CONTINUED)



Warning: Disconnect the power cord from the wall power supply prior to cleaning or disinfecting the BACTRON.

Avertissement: Avant d'effectuer toute entretien de cet appareil, débrancher le cordon secteur de la source d'alimentation.

If a hazardous material/substance has spilled in the BACTRONEZ, immediately initiate your site's Hazardous Material Spill Containment protocol. Contact your local Site Safety Officer and follow instructions per the site policy and procedures.

Periodic cleaning and the disinfection are required to prevent microbiological contamination.



Warning: Never clean or disinfect the BACTRONEZ with alcohol or flammable cleaners.

Avertissement: Ne jamais nettoyer l'appareil à l'alcool ou avec des nettoyeurs inflammables.

Note: Do not use spray cleaners or disinfectants that might leak through openings and cracks and get on electrical components, or that contain solvents that will harm coatings. Do not use chlorine-based bleaches or abrasives; these will damage the interior surfaces.

CLEANING

Note: The BACTRONEZ's chamber and incubator should be cleaned and disinfected prior to first use.

1. Remove all items (shelves, racks, and any additional items) from the incubator(s).
2. Clean the workstation's interior with a mild soap and water solution, including all corners.
3. Clean all removable accessories including arm port doors, gaskets, and sleeve assemblies with a mild soap and water solution.
4. Rinse with distilled water and wipe dry with a soft cloth. **Do not use deionized water.** See the [Distilled and Deionized Water](#) paragraph in the Operation section.
5. Take special care when cleaning around the pass box door alarm sensors and chamber power outlets to prevent damage.
6. **Do not use chloride-based cleaners** except Zephiran benzalkonium chloride solution. Other types may have adverse effects on microbiological samples.
7. Wipe down the interior surfaces with Zephiran. Do not wipe up, allow the Zephiran to evaporate.

USER MAINTENANCE (CONTINUED)

DISINFECTING

Disinfect the BACTRONEZ on a regular basis. Perform the following steps to disinfect the workstation:

1. Turn the unit off. Open all doors and carryout your laboratory or production space disinfection protocol.
2. After completion of your institutional protocol, allow all disinfectants to evaporate completely. Wipe down all surfaces, except the acrylic glass panels, with distilled water and Zephiran until the unit no longer has a volatile odor. Use nonabrasive wipes.
3. Remove all of the interior parts (shelves, racks, and any additional items) from the incubators. Disinfect the workstation, including all corners, the incubator interiors, and the pass box, using a suitable disinfectant. Take special care when cleaning around the pass box door and arm port door gaskets so as not to impair the positive seal.
4. Disinfect the BACTRONEZ using commercially available disinfectants that are non-corrosive, non-abrasive, and suitable for use on stainless steel surfaces. Contact your local Site Safety Officer for detailed information on the proper disinfectants suitable for your applications.
5. Do not use overtly volatile disinfecting agents. Chlorines, amphyls, and quaternary ammonias will evaporate into the chamber environment. Over time the concentration in the chamber atmosphere will continue to increase, potentially leading to inhibited growth, reproduction, or metabolic symptoms in sample populations.

VACUUM PUMP MAINTENANCE

Refer to the operation manual supplied with your vacuum pump for recommended maintenance routines.

USER MAINTENANCE (CONTINUED)

MAINTAINING THE ACRYLIC GLASS PANELS

Sheldon Manufacturing recommends using Novus brand acrylic glass cleaner and scratch remover for cleaning and maintaining the BACTRON's acrylic glass surfaces. Please see the [Accessories section](#) on page 61. Alcohol or alcohol-based solvents and other aggressive solvents should never be used to clean the BACTRONEZ, and may damage the acrylic glass panels

Never expose the BACTRONEZ to sustained UV light. Prolonged exposure to UV will result in rapid aging of the acrylic glass, leaving it vulnerable to compression forces, and generating cracks across all exposed areas. UV light will also quickly age sleeve assemblies, turning the sleeves yellow and result in a quick loss of elasticity.

Disable or redirect laboratory UV lighting away from the BACTRONEZ. The BACTRONEZ should not be exposed to direct sunlight. Verify that your laboratory or workspace environment does not use UV lighting at night. This type of light is usually referred to as short wave UVC or germicidal UV light, and operates at roughly 254nm.

Damage from prolonged or high intensity UV exposure is not covered under the warranty. Periodic use of long-wave (365nm) UV hand lamps used for bacterial identification should not damage the acrylic glass.

ELECTRICAL COMPONENTS

Electrical components do not require maintenance. If the BACTRONEZ's electrical systems fail to operate as specified, please contact your Shel Lab dealer, distributor, or Technical Support for assistance.

USER MAINTENANCE (CONTINUED)

CONDENSATION AND THE DEW POINT

Relative humidity inside the BACTRONEZ should never exceed 80% at 25°C. Exceeding this threshold will likely result in condensation on incubator and workspace surfaces.

Condensation will appear wherever the humidity level in the chamber reaches the dew point. The dew point is the level of humidity at which the air cannot hold more water vapor. The warmer the air, the more water vapor it can hold.

As the level of humidity rises in the chamber, condensation will first appear on surfaces that are cooler than the air temperature. Near the dew point, condensation will form on any item or exposed surface that is even slightly cooler than the air. When the dew point is reached, condensation forms on nearly all exposed surfaces.

Mild condensation can be present in BACTRONEZ units fully loaded or loaded to near capacity with open media plates, depending on ambient temperature and humidity. Cold air blowing on the exterior of the BACTRONEZ may help to cause condensation in the chamber by chilling the acrylic glass panels or metal bulkheads.

Managing excessive condensation primarily depends on either lowering the humidity level in the chamber or increasing the air temperature.

Note: Note: Rising or falling air pressure from weather will adjust the dew point up and down in small increments. If the relative humidity in the BACTRONEZ is already near the dew point, barometric fluctuations may push it across the dew point threshold.

If excessive condensation is forming in the BACTRONEZ chamber, check the following:

- Is the BACTRONEZ exposed to an external flow of cold air such as, an air-conditioning vent or a door to a cooler hallway or adjacent room? Block or divert the air, or move the incubator.
- Does the ambient humidity in the room exceed the BACTRON's stated operating range of 80% relative humidity? If so, lower the room's humidity.
- Does the number of media containers in the BACTRONEZ exceed its rating? The BACTRONEZ can hold 300 plates.
- Remove or cap open containers of water or media. Drain the condensate controller catch vessel. **Do not drain the manometer.**

UNIT SPECIFICATIONS

The BACTRONEZs is a 110 - 120 workstation. Please refer to your workstation's data plate for individual electrical specifications.

Technical data specified applies to units with standard equipment at an ambient temperature of 25°C (77°F) and a voltage fluctuation of ±10%. The temperatures specified are determined in accordance to factory standard following DIN 12880 respecting the recommended wall clearances of 10% of the height, width, and depth of the inner chamber. All indications are average values, typical for units produced in the series. We reserve the right to alter technical specifications at all times.

WEIGHT

Model	Shipping Weight
BACTRONEZ	480bs / 217kg

WORK STATION DIMENSIONS

By inches

Model	Exterior W × D × H	Workspace Chamber W × D × H
BACTRONEZ	48.7 x 31.3 x 26.5 inches	33 x 28.5 x 25.2 inches

By centimeters

Model	Exterior W × D × H	Interior Chamber W × D × H
BACTRONEZ	124 x 79.5 x 67.3 cm	83.8 x 72.4 x 64 cm

UNIT SPECIFICATIONS (CONTINUED)

STAND DIMENSIONS

Model	Inches W × D × H	Centimeters W × D × H
BACTRONEZ	49 x 30 x 30 inches	124 x 76.2 x 76.2cm

INCUBATOR DIMENSIONS

Workspace Chamber Incubator

Model	Inches W × D × H	Centimeters W × D × H
BACTRONEZ	27.5 x 8 x 13.5	70 x 20 x 34

PASS BOX INTERIOR DIMENSIONS

Model	Inches W × D × H	Centimeters W × D × H
BACTRONEZ	9 x 10.7 x 9	23 x 27.2 x 23

PASS BOX PLATE CAPACITY

Model	Plates
BACTRONEZ	90

PASS BOX VOLUME

Model	Cubic Feet	Cubic Liters
BACTRONEZ	1.1	31

UNIT SPECIFICATIONS (CONTINUED)

CHAMBER CAPACITY

Workspace Chamber Volume

Model	Cubic Feet	Cubic Liters
BACTRONEZ	13.7	388

Workspace Incubator Volume

Model	Cubic Feet	Cubic Liters
BACTRONEZ	1.4	39.6

TOTAL PLATE CAPACITY

Model	Plates
BACTRONEZ	300

TEMPERATURE

Model	Range	Incubator Uniformity
BACTRONEZ	Ambient +5°C to 70°C	±0.5°C @ 37°C

POWER

Model	AC Voltage	Amperage	Frequency
BACTRONEZ	110-120	9	50/60 Hz

PARTS LIST

Description	Parts Number
Anaerobic Indicator Strips (A box of 100 packets)	9900706
Pass Box Door Gasket 9 x 9, Burgundy (inner and outer door)	3450506
Arm Port Door Left	9900699
Arm Port Door Right	9900698
Arm Port Door O-Ring	6000509
Catalyst Holder Assembly (Includes Catalyst Cartridge)	9990759
Foot Pedal Assembly	9990735
Gas Regulator Assembly, Anaerobic Mixed Gas	9740501
Leveling Foot	2700506
Petrie Dish Rack 2 x 11 inches (5 X 28cm)	5110729
Petrie Dish Rack 2 x 13 inches (5 X 33cm)	5110730
Power Cord 5-15 NEMA	1800540
Shelf Spacer	5680502
Sleeve Assembly Size 7 Small (2 cuffs, 2 cuff-rings, 4 O-rings, 2 sleeves, 2 straps)	9990738S
Sleeve Assembly Size 8 Medium (2 cuffs, 2 cuff-rings, 4 O-rings, 2 sleeves, 2 straps)	9990738M
Sleeve Assembly) Size 9 Large (2 cuffs, 2 cuff-rings, 4 O-rings, 2 sleeves, 2 straps)	9990738L
Sleeve Assembly) Size 6.5 Extra Small (2 cuffs, 2 cuff-rings, 4 O-rings, 2 sleeves, 2 straps)	9990738XS
Sleeve Cuff-Ring 4 Inches (interior diameter)	6400590
Sleeve Cuff-Ring O-ring	6000504
Sleeve Cuff-Ring 3.5 Inches (interior diameter) Small	6400619
Sleeve Cuff-Ring Red O-ring	6000503
Sleeve Cuffs Latex (for sleeve assembly) size 8	3600501
Sleeve Cuffs Latex (for sleeve assembly) size 9	3600502
Sleeve Cuffs Nitrile (for sleeve assembly) size 7	3600513
Sleeve Cuffs Nitrile (for sleeve assembly) size 8	3600514
Sleeve Cuffs Nitrile (for sleeve assembly) size 9	3600515
Sleeve 10 inches (25 cm)	3600521
Vacuum Pump 110-120 Volt	9740502

PARTS (CONTINUED)

ORDERING PARTS AND CONSUMABLES

If you have the Part Number for an item, you may order it directly from Sheldon Manufacturing by calling 1-800-322-4897 extension 1. If you are uncertain that you have the correct Part Number, or if you need that specific item, please contact Sheldon Technical Support for help at 1-800-322-4897 extension 2 or (503) 640-3000. Please have the **model number** and **serial number** of the BACTRONEZ ready, as Tech Support will need this information to match your workstation with its correct part.

ACCESSORIES

Shel Lab offers the following BACTRONEZ accessories and kits for sale. Please see our website for prices.

The BACTRONEZ Essentials Kit



Includes an exterior LED light, vacuum pump, AMG regulator, foot pedal assembly, ergonomic grip catalyst, and 7 petri plate racks (2 x 11 inches / 5.1 x 27.94 cm).

Part Number 917-995-0005

Acrylic Glass Cleaner (8 oz)

Novus brand acrylic / plastic glass cleaner.

Part Number 1060503



Acrylic Glass Scratch Remover (2 oz)

Helps remove visible scratches and nicks from acrylic glass.

Part Number 1060504



Anatox Activated Charcoal (2 lbs / 0.9 kgs)

For scrubbing hydrogen sulfides, fatty acids, and some toxic or corrosive compounds from the workstation's atmosphere.

Part Number 1060500.



ACCESSORIES (CONTINUED)

Anatox Fan

Holds Anatox charcoal filters and significantly speeds the removal of sulfides, fatty acids, and toxic or corrosive compounds.

Part Number 9490578



Anaerobic Indicator Strips

A box of 100 Oxoid anaerobic indicator strips.

Part Number 9900706



CAT 180 Bake Catalyst Oven

A small, slide-loading desktop oven designed specifically for baking out BACTRON catalysts. Features automatic baking and cooling cycles.

Part Number CAT180



Compressed Gas Cylinder Switcher, Automatic

Allows two gas cylinders to be connected to one gas port, and automatically switches from the first to the second cylinder when the first is empty.

Part Number 2002-B



Bacloop Metal Inoculation Loop Sterilizer

A small resistance based heater for microbiology applications.

Part Number 9490505



BACTRONEZ: Stand BAC1

A rolling stand with cabinet for the BACTRONEZ.

49 x 30 x 30 inches

(124.5 X 76.2 x 76.2 cm)

Part Number 9000510

ACCESSORIES (CONTINUED)

Leak Detector for BACTRONEZ Anaerobic Chambers

A handheld gas detector for locating leaks. Recommended for units that have been in service for four (4) or more years.

Part Number 4600501



Lukas Fiber Optic Micro Lite Illumination System

A fiber optic, adjustable brightness, halogen light box and guide. Provides a stable, long lasting light for use with BACTRONEZ workstations and stereo microscopes.

Part Number 4650503



Nitrogen Regulator Assembly

Delivery gauge range of 2 – 40 PSIG. Includes barbed adaptor fitting and 10 feet (3 meters) of flexible tubing.

Part Number 9740546



UV Viewing Lamp

A handheld UV lamp for use with BACTRONEZ workstations.

Parts Number 9490507



Zephiran Benzalkonium Chloride Chamber Cleaner

1 Gallon, 0.133%.

Part Number 1060501

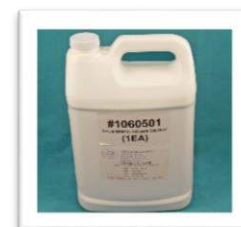

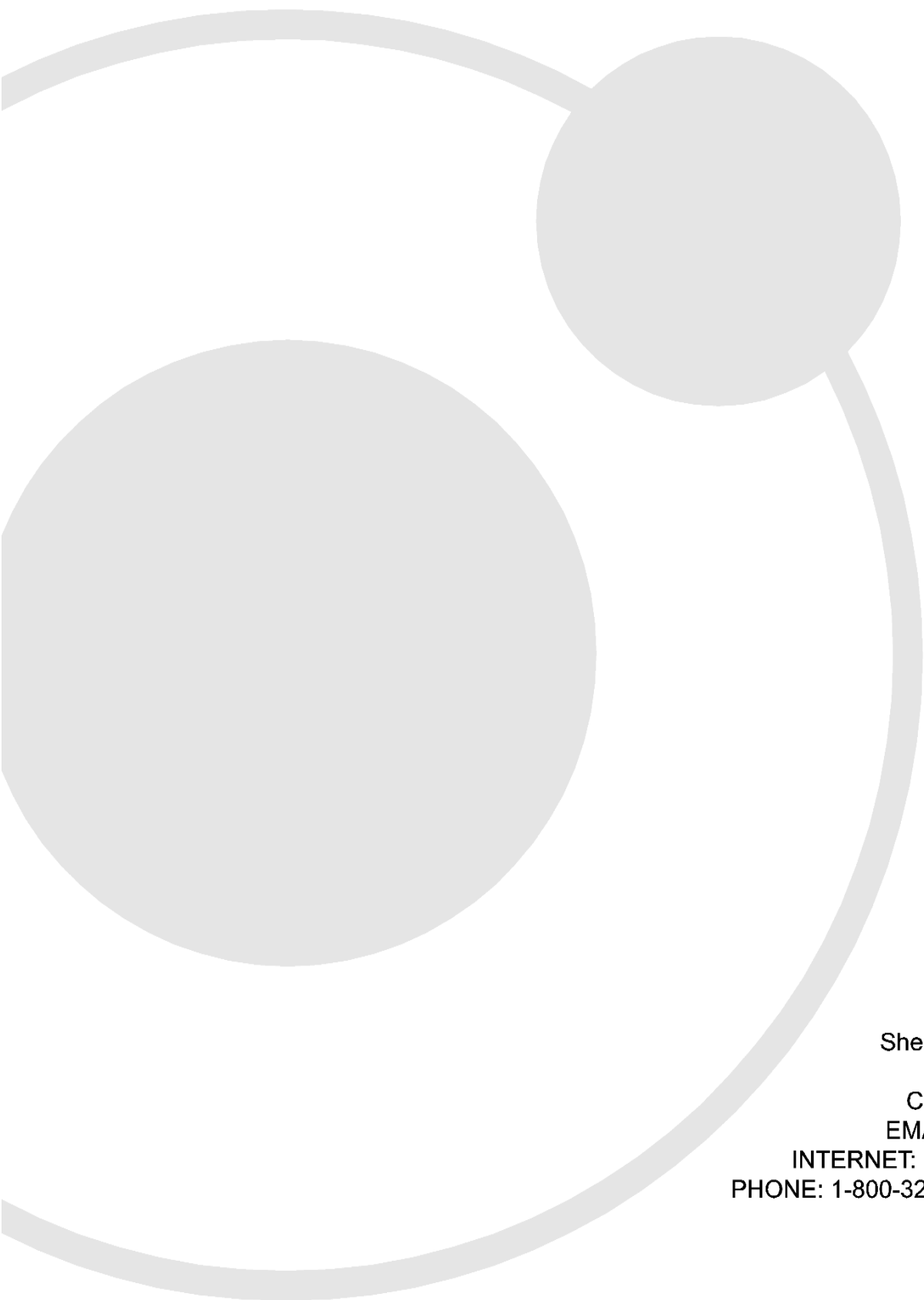

Sheldon Manufacturing Inc.
P.O. Box 627
Cornelius, Oregon 97113
EMAIL: tech@Shellab.com
INTERNET: <http://www.Shellab.com>
PHONE: 1-800-322-4897 (503) 640-3000
FAX: (503) 640-1366

SHELLAB®