

Operator Manual

ANATEL TOC600 ONLINE ANALYZER



EXCELLENCE IN PROCESS ANALYTICS

Table of Contents

1	Introduction	
1.1	TOC600 Analyzer Features	13
1.2	Operational Overview	13
2	Instrument Installation	
2.1	General Information	15
2.2	Pre-Installation Procedures.....	15
2.2.1	<i>Unpacking and Inspection</i>	15
2.2.2	<i>Operational Verification</i>	16
2.2.3	<i>Software Setup</i>	17
2.3	Hardware Installation	21
2.3.1	<i>C80 Controller Mounting</i>	21
2.3.2	<i>TOC600 Analyzer Mounting</i>	22
2.3.3	<i>Plumbing Connections</i>	23
2.3.4	<i>Communications Connections</i>	27
2.3.5	<i>Power Connections</i>	31
2.4	Analyzer Initialization	32
3	Network Installation	
3.1	General Information	35
3.2	Software Setup	35
3.2.1	<i>ID to S/N Cross Reference</i>	35
3.2.2	<i>Controller Address</i>	37
3.3	Network Setup	37
3.3.1	<i>TOC600 Network Connections</i>	39
4	C80 Controller Setup	
4.1	General Information	41
4.2	C80 Controller.....	41
4.3	Operational	42
4.4	Contrast Adjustment	43
4.5	View Options.....	44
4.5.1	<i>Single Channel View</i>	45
4.5.2	<i>Multichannel View</i>	45
4.5.3	<i>Channel Display</i>	46

5	TOC600 Analyzer Setup	
5.1	General Information	49
5.2	Factory Defaults.....	49
5.3	Password Security	51
5.4	Display Units	54
5.5	Auto TOC Mode	57
	5.5.1 Auto TOC Software Setup	61
	5.5.2 Auto TOC Mode Printout	68
5.6	Purge Mode	70
	5.6.1 Purge Mode Printouts.....	71
5.7	Header Print.....	75
5.8	Manual Mode	76
5.9	Online Samples.....	76
6	Calibration and Validation	
6.1	General Information	79
6.2	TOC Calibration	80
6.3	TOC Validation.....	84
6.4	Conductivity Calibration	88
6.5	System Suitability.....	91
6.6	Data History	95
7	TOC600 Analyzer Alarms	
7.1	General Information	97
7.2	Software Setup	97
	7.2.1 Alarm Setup.....	97
	7.2.2 Beeper Setup.....	100
7.3	Alarm Reporting.....	101
	7.3.1 Uncompensated Conductivity Alarms.....	102
7.4	Alarm Acknowledgement	105
8	Printer Output	
8.1	General Information	109
8.2	Hardware Setup	109
8.3	Software Setup	111
	8.3.1 Internal Log.....	111
	8.3.2 Printouts	114

9 Analog Outputs

9.1	General Information	119
9.2	TOC Output.....	119
9.2.1	<i>Hardware Setup</i>	119
9.2.2	<i>Software Setup</i>	121
9.3	Optional Conductivity/Resistivity and Temperature Outputs.....	128
9.3.1	<i>Hardware Setup</i>	128
9.3.2	<i>Software Setup</i>	129

10 Digital Inputs and Outputs

10.1	General Information	137
10.2	Digital Inputs	137
10.2.1	<i>Hardware Setup</i>	138
10.2.2	<i>Software Setup</i>	138
10.3	Digital Outputs	140
10.3.1	<i>Hardware Setup</i>	140

11 12 VDC Bias Output

11.1	General Information	141
11.2	Hardware Setup	141

12 Serial Communications

12.1	General Information	145
12.2	Hardware Setup	145
12.3	TOC600 Analyzer Command Set	146
12.3.1	<i>Mode Set Commands</i>	146
12.3.2	<i>Parameter Set Commands</i>	147
12.3.3	<i>Data Read Commands</i>	149
12.3.4	<i>Log Commands</i>	150
12.3.5	<i>Data History Commands</i>	150

13 TOC600 Analyzer Maintenance

13.1	General Information	151
13.2	Enclosure Cleaning.....	151
13.3	Self-Cleaning Mode	152
13.4	Preparatory Maintenance Procedures	153
13.5	UV Lamp Replacement.....	155
13.6	Air Filter Cleaning	161
13.7	Inlet Filter Replacement.....	162

14 Troubleshooting

14.1	General Information	165
14.2	Alarm Codes	165
14.3	Troubleshooting	168
14.3.1	<i>Draining the Instrument</i>	171
14.4	Sensor Diagnostics	172
14.4.1	<i>Electronics Tests</i>	173
14.4.2	<i>Cell Tests</i>	174
14.4.3	<i>I/O Tests</i>	175

Appendix A:Service Procedures

A.1	Return Procedures.....	179
A.2	Technical Support Information.....	179

Appendix B:Specifications and Accessories

B.1	Performance Specifications	181
B.2	Physical Specifications	182
B.2.1	<i>Panel Mount C80 Controller</i>	182
B.2.2	<i>TOC600 Analyzer</i>	183
B.3	Accessories.....	184
B.3.1	<i>Thermal Printer</i>	184

Appendix C:Certifications

C.1	Overview.....	185
-----	---------------	-----

Appendix D:Glossary

Manual Overview

About This Manual

The information in this manual has been carefully checked and is believed to be accurate. However, Hach Ultra assumes no responsibility for any inaccuracies that may be contained in this manual. In no event will Hach Ultra be liable for direct, indirect, special, incidental, or consequential damages resulting from any defect or omission in this manual, even if advised of the possibility of such damages. In the interest of continued product development, Hach Ultra reserves the right to make improvements in this manual and the products it describes at any time, without notice or obligation.

Published in the United States of America

Hach Ultra P/N: FG5804001 Edition 1, July 2006

Copyright © 2006 by Hach Ultra Analytics, Inc.

All rights reserved. No part of the contents of this manual may be reproduced or transmitted in any form or by any means without the written permission of Hach Ultra.

Safety Conventions



WARNING

A warning is used to indicate a condition which, if not met, could cause serious personal injury and/or death. Do not move beyond a warning until all conditions have been met.

CAUTION:

A caution is used to indicate a condition which, if not met, could cause damage to the equipment. Do not move beyond a caution until all conditions have been met.

Note:

A note is used to indicate important information or instructions that should be considered before operating the equipment.

General Safety Considerations

- Read the *TOC600 Analyzer Operator Manual* thoroughly before installing or operating the instrument. Although the TOC600 is designed for rugged use, it is still an instrument that should be cared for and maintained as described in this manual. Following proper safety and handling instructions will promote accident free operation and prolong product life.
- For any questions regarding the TOC600 Analyzer, contact Hach Ultra at 800.866.7889 or +1-541.472.6500.
- All service procedures should be conducted by properly trained service personnel.
- Make sure the TOC600 Analyzer is properly installed and all connections are correctly installed before operation. All safety guidelines should be observed.
- Follow all procedures in [“Return Procedures” on page 179](#) before shipping a unit to a service center for repair or re-calibration.



WARNING

Only factory certified personnel should perform service of the TOC600. Attempts by untrained personnel to disassemble, alter, modify or adjust the electronics and/or hydraulics may result in personal injury and damage to the TOC600.

TOC600 Analyzer Warnings and Cautions

CAUTION:

The TOC600 Analyzer must be plumbed correctly for proper sample flow through the instruments and accurate analysis results.

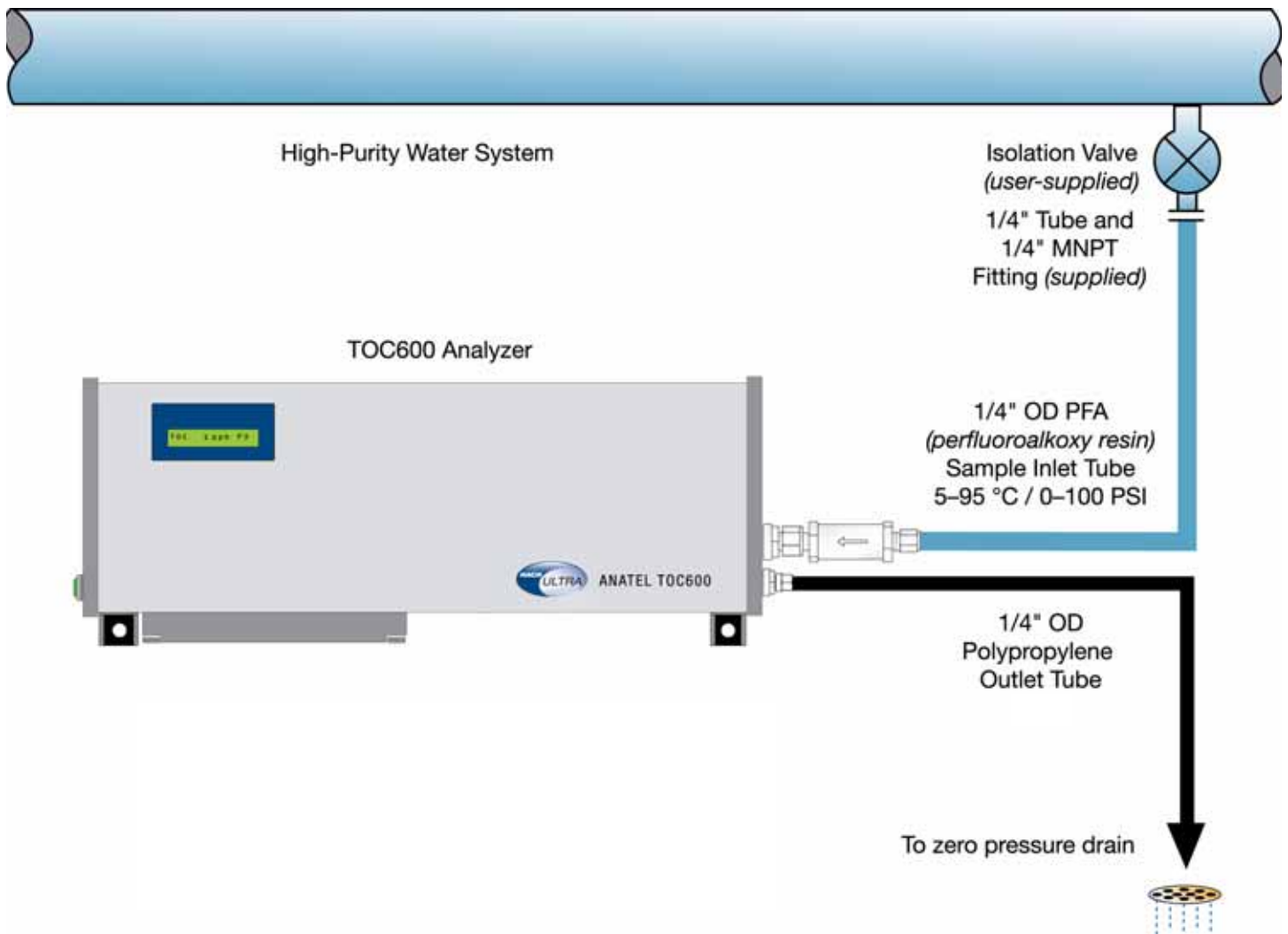

This instrument has been tested and found to be in conformity with the following EU Directive:

- EMC Directive 89/336/EEC Low Voltage Directive 73/23/EEC

This instrument is in conformity with the relevant sections of the following EC Technical Standards and other normative documents:

- Safety: EN 61010-1:1993 + A2:1995
- EMC: EN 61326:1998
 EN 55011:1999
 EN 61000-3-2:1995 + A14:2000
 EN 61000-3-3:1997
 EN 61000-4-2:2001
 EN 61000-4-3:2001
 EN 61000-4-4:2001
 EN 61000-4-5:2001
 EN 61000-4-6:2001
 EN 61000-4-11:2001

Note:

The CE Marking applies only to 230 VAC instruments and has been affixed on the devices according to the EU Directives noted above.

The TOC600 Analyzer supports compliance with those parts of FDA 21 CFR Part 11 concerning the collection, retention, access and retrieval of data as electronic records. The instrument uses no electronic signature(s), thus those parts of the rule referring to electronic signature(s) are not applicable. Extensively documented and verifiable tests have been conducted to establish 21 CFR Part 11 compliance.

The TOC600 Analyzer System is comprised of a line of precision instruments which meet or exceed the following international requirements and standards of compliance:



EN61010–1 & EN 61326

Electrical Equipment for Laboratory Use



ETL Listed: Conforms to **UL 61010-1** & Certified to **CSA 22.2 No. 61010-1**

In addition, the following international symbols are found on the instrument:



High Voltage

Reference Document: ISO 3864, No. B.3.6



Standby

Reference Document: IEC 417–5009



Earth Ground

Reference Document: IEC 417–5017



Protective Earth Ground

Reference Document: IEC 417–5019



Conformity with EU Directive 2002/96/EC. See [“Certifications” on page 185](#) for details.

**WARNING**

The UV lamp used for oxidation by the TOC600 Analyzer emits ultraviolet radiation and contains small amounts of mercury. When replacing it, dispose of the expired UV lamp in accordance with applicable local regulations. Hach Ultra accepts used lamps for proper disposal. Refer to [“Return Procedures” on page 179](#) for guidelines.

**WARNING**

The TOC600 Analyzer contains high voltage electronics. Always physically disconnect power from the instrument before performing maintenance procedures to avoid potential electrostatic discharge resulting in possible shock or damage to instrument components. Although the instrument’s electronics and analysis modules are physically separated and the enclosure is NEMA 12-compliant, components are not completely protected against external conditions. Do not subject the TOC600 Analyzer to direct water streams or other adverse environmental elements.

**WARNING**

The calibration and validation processes employed by the TOC600 Analyzer use chemicals and a photooxidation technology which produces hazardous waste byproducts. The effluent is potentially dangerous both personally and environmentally. Analyzer wastes generated during calibration and validation procedures must be disposed of in accordance with all applicable local regulations.

**WARNING**

The TOC600 Analyzer’s onboard lithium battery presents a potential fire, explosion and burn hazard. Properly dispose of expired batteries. Do not attempt to incinerate, recharge or disassemble.

**WARNING**

The TOC600 Analyzer’s fittings and sample vessel may become hot during operation if the sample water is hot, thereby creating a potential burn hazard. Make sure parts and surfaces are cool to the touch before proceeding with procedures.

**WARNING**

Use the grounded power cord provided and do not clip the ground pin.

Warranty

Hach Ultra warrants that this instrument will be free of defects in materials and workmanship for a period of one (1) year from the shipping date. If any instrument covered under this warranty proves defective during this period, Hach Ultra will, at its option, either repair the defective product without charge for parts and labor, or provide an equivalent replacement in exchange for the defective product.

To obtain service under this warranty, the customer must notify the nearest Hach Ultra service support center on or before the expiration of the warranty period and follow their instructions for return of the defective instrument. The customer is responsible for all costs associated with packaging and transporting the defective unit to the service support center, and must prepay all shipping charges. Hach Ultra will pay for return shipping if the shipment is to a location within the same country as the service support center.

This warranty shall not apply to any defect failure or damage caused by improper use or maintenance or by inadequate maintenance or care. This warranty shall not apply to damage resulting from attempts by personnel other than Hach Ultra representatives, or factory-authorized and trained personnel, to install, repair or service the instrument; to damage resulting from improper use or connection to incompatible equipment; or to instruments that have been modified or integrated with other products when the effect of such modification or integration materially increases the time or difficulty of servicing the instrument.

THIS WARRANTY IS GIVEN BY HACH ULTRA ANALYTICS, INC. WITH RESPECT TO THIS INSTRUMENT IN LIEU OF ANY OTHER WARRANTIES, EXPRESSED OR IMPLIED. HACH ULTRA ANALYTICS, INC. AND ITS VENDORS DISCLAIM ANY IMPLIED WARRANTIES OF MERCHANTABILITY OR FITNESS FOR A PARTICULAR NON-CONTRACTUAL PURPOSE. HACH ULTRA ANALYTICS, INC.' RESPONSIBILITY TO REPAIR OR REPLACE DEFECTIVE PRODUCTS IS THE SOLE AND EXCLUSIVE REMEDY PROVIDED TO THE CUSTOMER FOR BREACH OF THIS WARRANTY. HACH ULTRA ANALYTICS, INC. AND ITS VENDORS WILL NOT BE LIABLE FOR ANY INDIRECT, SPECIAL, INCIDENTAL, OR CONSEQUENTIAL DAMAGES EVEN IF HACH ULTRA ANALYTICS, INC. OR ITS VENDORS HAS BEEN GIVEN ADVANCED NOTICE OF THE POSSIBILITY OF SUCH DAMAGES.

Patents

Apparatus and products are manufactured and sold by Hach Ultra Analytics, Inc. under one or more of the following U.S. patents: 4,626,413; 4,666,860; 4,683,435; 4,868,127; 5,047,212; 5,260,663; 5,275,957; 5,334,940; 5,677,190 and equivalents in other countries where issued. Purchaser is granted a paid-up, non-exclusive license to practice under these patents for the useful life of this apparatus or product.

Revision History

- Edition 1, July 2006, Hach Ultra Analytics, Inc.

Acknowledgements

- Anatel is a registered trademark of Danaher Corporation.
- Hyperterminal is a registered trademark of Hilgraeve, Incorporated Corporation.
- Lexan is a registered trademark of General Electric Company Corporation.
- Teflon is a registered trademark of E. I. Du Pont De Nemours and Company Corporation.

1 Introduction

The Anatel TOC600 Analyzer is designed to provide high-purity water processing, specifically addressing pharmaceutical industry needs. Building on the proven success of Hach Ultra's line of TOC Analyzers, the TOC600 Analyzer offers measurement capabilities which meet the requirements of the United States Pharmacopoeia (USP).

The TOC600 Analyzer integrates analytical Sensors with managing Controllers in a wide range of configurations that afford maximum flexibility to address a wide range of process requirements. Multiple TOC600 Analyzers can be associated with a single C80 Controller to observe several process points from one location. Alternatively, multiple Controllers can be networked to display TOC600 Analyzer readings at several locations.

1.1 TOC600 Analyzer Features

Anatel TOC600 Analyzers offer several advantages in the monitoring of ultrapure water systems:

Calibration and Validation	The TOC600 Analyzer can be calibrated with from one to three TOC standards using pre-packaged Calibration Standards available from Hach Ultra. Calibration and instrument performance can be validated online using the Hach Ultra Validation Kit.
USP Compliance for Conductivity and System Suitability	The TOC600 Analyzer's limit response and response efficiency are calculated online automatically to determine compliance with USP TOC Method <643>. The cell constant also can be verified online to comply with USP Conductivity Method <645>.
Hot Water Application	The TOC600 Analyzer is fully compatible with water temperatures up to 70 °C. For water temperatures from 70 °C to 95 °C, an external heat exchanger is required. The only wetted part in the Anatel Heat Exchanger is 316 stainless steel tubing.
Individual Alarm Monitoring	TOC levels may be monitored for all connected TOC600 Analyzer Analyzers and compared to user-defined alarm limits for each instrument. The user is alerted to any limit excursions by the C80 Controller which flashes its LCD display as well as the Sensor's corresponding LED. An audible beep or user-supplied external alarm may be enabled for additional warning. The TOC600 Analyzer also can be set to signal at USP recommended uncompensated conductivity levels.
Local Area Networking (LAN) Capability	The ability to link as many as eight TOC600 Analyzer Analyzers to a single C80 Controller provides timely readings of TOC levels even at the most distant and crucial areas of the water system. The C80 Controller can be mounted wherever convenient to make the TOC levels at several key locations immediately available on a single display. Analog, Digital I/O, Serial and 12 VDC Bias connections allow quick and easy connection to any external device to further enhance system capabilities.

1.2 Operational Overview

The TOC600 Analyzer employ a patented photocatalytic method which measures the conductivity of the sample before and after its oxidation by ultraviolet (UV) light. The water sample is isolated from the ambient environment to eliminate external contamination and the TOC concentration is determined using an algorithm that measures the change in the sample's conductivity. The change in conductivity is a direct function of the amount of organic carbon

present and its oxidation to carbon dioxide (CO_2), allowing the TOC content of the sample water to be calculated.

The results of each sample analysis are digitally displayed on the front panel of the corresponding Sensor, and its supervisory C80 Controller, as a concentration of TOC in ppb. Additionally, conductivity (in $\mu\text{S}/\text{cm}$) or resistivity (in $\text{M}\Omega\text{-cm}$), uncompensated for temperature or corrected to 25°C , and sample temperature are measured then displayed. A selection of data printouts is available.

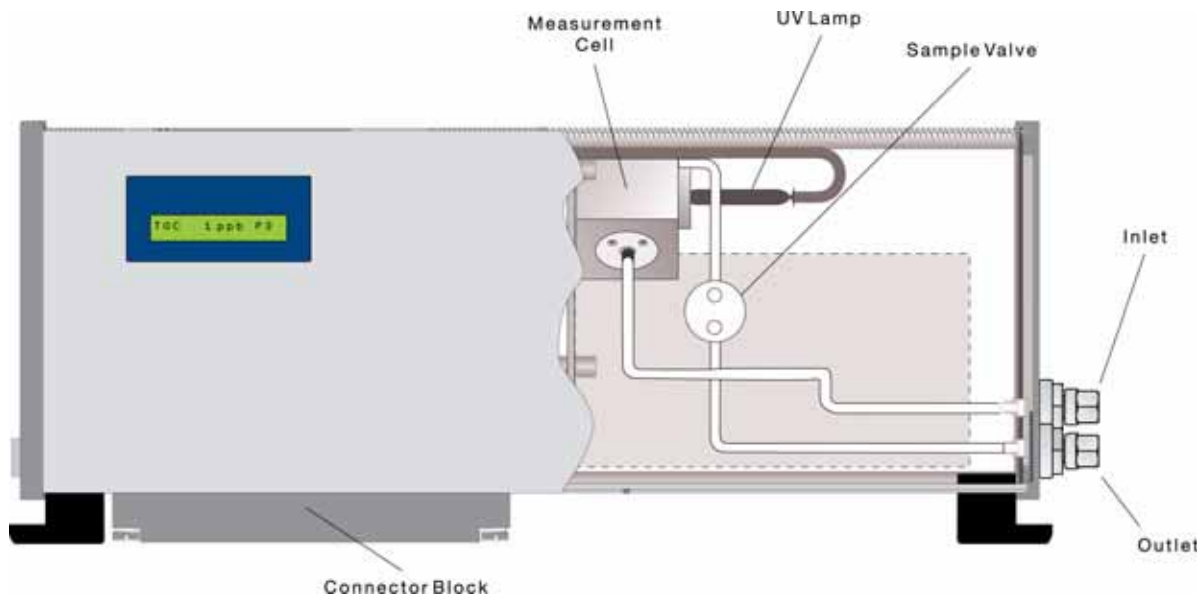

Fig 1-1 : TOC600 Analyzer Components

An integral alarm scheme reports any abnormalities detected during Analyzer operation. A TOC limit (or uncompensated conductivity limit) excursion is automatically output to a printer and logged for display on associated C80 Controllers.

The TOC600 also performs ongoing TOC trend analyses to facilitate water quality management. Each instrument measures the change in TOC over the past hour and reports its directional trend. By further examining the exact TOC values on a printout, the user can determine if the trend is critical and respond accordingly.

2 Instrument Installation

2.1 General Information

The Anatel TOC600 Analyzer configuration consists of an Analyzer and a C80 Controller. Additional Analyzers and Controllers can be integrated to create a local area network. See [“Network Installation” on page 35](#).

Each TOC600 is furnished with an Installation Kit (PN AS600601) and must consider these preparatory and installation issues:

Table 2-1 : Preparatory and Installation Issues

Procedure	C80	TOC600 Analyzer
Inspection	X	X
Verification	X	X
System Time	N/A	X
Sensor Name	N/A	X
Mounting	X	X
Plumbing	N/A	X
External Communications	X	X
Auxiliary I/Os	N/A	X
Power	X	X
Self-Cleaning	N/A	X

2.2 Pre-Installation Procedures

Preliminary setup procedures should be conducted on the TOC600 Analyzer before installation on the water system for proper operation. Verification is easier at this stage than after the components have been mounted and cabling has been run. Suggested pre-installation procedures are:

- Unpacking, visually inspecting the equipment and verifying the packing list.
- Powering up the Analyzer to verify that all the components are operational (refer to [“Specifications and Accessories” on page 181](#) for the specific power requirements of each component).
- Setting up the operational software by entering the System Time and naming the Analyzer.

2.2.1 Unpacking and Inspection

Upon receiving the TOC600, inspect the shipping container(s) for any signs of external damage before unpacking the components. Carefully remove the equipment, verify the enclosed packing list and check once again for obvious damage.

Each TOC600 Analyzer Installation Kit contains:

- Power Cord
- Network “Tee” & Terminator
- 15 Micron Inlet Filter
- 10’ 1/4” OD Sample Tubing
- 10’ 1/4” OD Drain Tubing
- 1/4” Tube x 1/4” MNPT Fitting
- *Operator Manual and Standard Operating Procedures (SOPs)*

If damage is apparent, notify the freight carrier immediately. Claims must be filed by the customer. Also notify Hach Ultra of any such problems. Include the Serial Number of the damaged unit(s) and purchase order number with all factory communications.

2.2.2 Operational Verification

The next pre-installation step is to establish communication connections between the C80 Controller and its associated TOC600 Analyzer.

Each TOC600 Analyzer and C80 Controller is supplied with a 3-foot local cable, a twin BNC “tee” connector, and a passive terminator. The C80 Controller also includes a 10-foot trunk cable to facilitate communications connections.

Note:

Additional twin-axial trunk cable, pre-wired with BNC plugs at each end, is available from Hach Ultra in 10-, 25-, 50-, 100-foot and custom lengths.

To connect the Controller to the Analyzer:

- 1) Grasp the end of the 3-foot local cable attached to the C80 Controller and, noting the alignment of its internal pins, gently push it onto the middle coupling of the tee connector. Twist the cable onto the connector until it “locks” on the coupling.
- 2) Similarly fasten the Analyzer to its tee connector.
- 3) Link the two tees using the 10-foot section of twin-axial trunk cable provided.
- 4) Complete communications connections by placing a passive terminator on the open couplings at each end of the configuration. Proper termination is crucial for reliable communications.

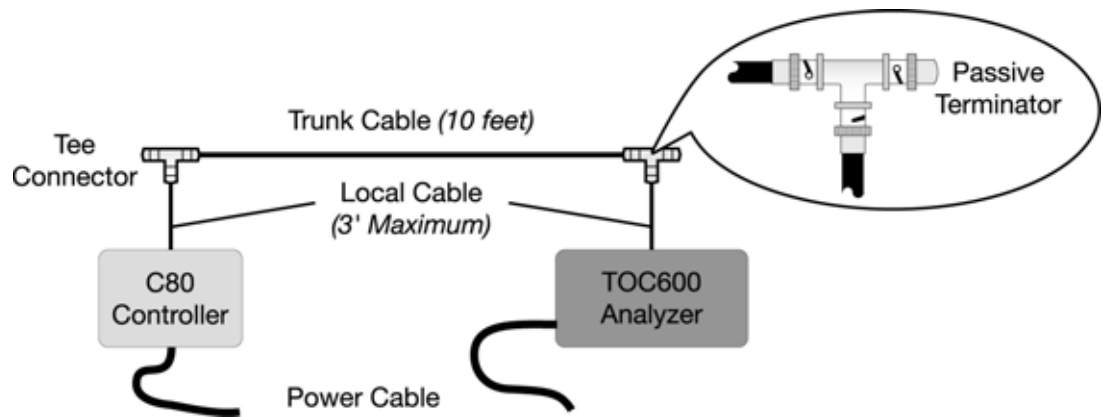

Fig 2-1 : Passive Terminator

- 5) Plug both components into an AC power source. A power cord is supplied with the TOC600; power is supplied to the C80 Controller through a 9 VDC wall mounted transformer that attaches similar to the communications connections.
- 6) Turn the Analyzer **ON**. Verify that the displays on both instruments illuminate and are functional.

The Controller display reports that it is establishing communications with the Analyzer. If **Sensor Head not communicating** is displayed or either instrument fails to operate, check the connections. Contact Hach Ultra Customer Service at 800.866.7889 or +1 541.472.6500 if these problems persist.

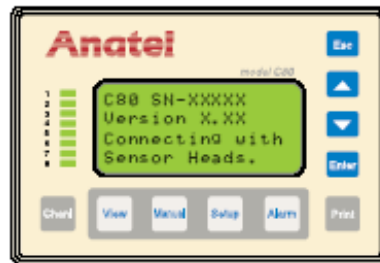

Fig 2-2 : C80 Login Screen

2.2.3 Software Setup

Note:

The following setup procedures are performed through the C80 Controller. Refer to [“C80 Controller Setup”](#) on page 41 if necessary for a description of this control device and its keyboard interface.

With communications established, define the **System Time** on the C80 Controller and give the TOC600 Analyzer a **Sensor Name**.

System Time

Each Analyzer's clock is set at the factory during testing. It should be checked, however, and altered if necessary to display local time.

To set the Controller's clock/calendar:

- 1) Press the **Setup Key** to display the **Setup Menu**.
- 2) Use the **Up** and **Down Keys** to specify System Setup.

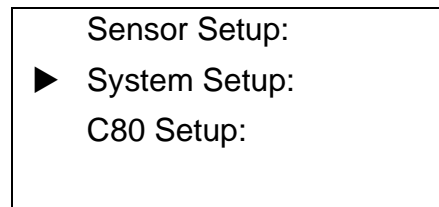

Fig 2-3 : Sensor Setup Selections

- 3) Press **Enter** to access its submenu.

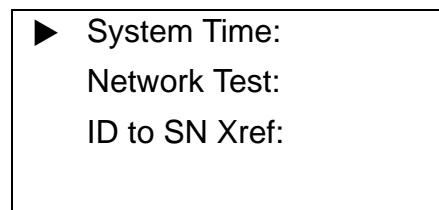

Fig 2-4 : System Time Submenu

- 4) Specify **System Time** and press **Enter** to display that parameter screen. The programmed Date is displayed numerically in a month/day/year format; the **Time** in an hour:minute format. A block cursor begins flashing to highlight the initial interval of the date.

Note:

*Although only the right digit of each of the **Date** and **Time** parameters is highlighted, the entire interval is selected.*

- 5) Modify the month, or use the **Up** and **Down Keys** to move the flashing cursor left or right, respectively, to highlight the division of the **Date/Time** display that is to be changed, such as the day.

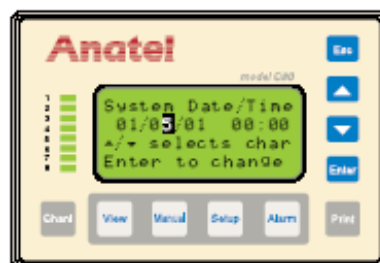

Fig 2-5 : System Time Screen

- 6) Press **Enter** to enable the Controller's Edit Mode. The flashing cursor becomes an underscore and the key functions change.

```

System Date/Time
01/01/06 00:00
Esc selects char
▲/▼ to change
  
```

Fig 2-6 : Controller Edit Selections

- 7) Use the **Up** and **Down Keys** to scroll the digit to display the current day numerically.

```

System Date/Time
01/05/06 00:00
Esc selects char
▲/▼ to change
  
```

Fig 2-7 : Current Day Display

- 8) Press **Enter** to retain the day setting and advance the block cursor to the year division of the clock/calendar setting.
- 9) Repeat the editing process to alter the other settings as necessary. The hour and minute are displayed in a 24-hour format; for example, 3:15 P.M. would be entered as **15:15**.

```

System Date/Time
01/05/00 15:15
Esc selects char
▲/▼ to change
  
```

Fig 2-8 : Current Time Display

- 10) With the System's date and time properly set, press **Enter** twice to return to the **System Setup Menu**. The supervisory Controller transmits the new date and time to its associated Analyzer so that its report functions are now synchronized to the clock/calendar setting.

```

▶ Sensor Setup:
System Setup:
C80 Setup:
  
```

Fig 2-9 : Sensor Setup Selections

Analyzer Name

Note:

Default: Serial Number

The first step in setting up an TOC600 Analyzer is to name it so that it can be identified on displays and printouts. Up to 13 alphanumeric characters may be assigned to name the instrument. It is suggested that the Analyzer's **Sensor Name** be chosen based on its location, function or other relevant designation.

To name an TOC600 Analyzer:

- 1) With **Sensor Setup** highlighted on the Setup Menu, press **Enter**.

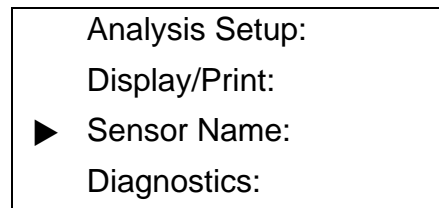

Fig 2-10 : Analysis Setup Selections

- 2) Specify **Sensor Name** and press **Enter** to display that parameter screen. The first line of the display identifies the chosen Analyzer by its Channel ID Number. The second line presents its default name (its Serial Number) with the block cursor flashing on the first character.



Fig 2-11 : Sensor Name Screen

- 3) Use the **Up** and **Down Keys** to move the cursor and highlight the character that is to be changed.
- 4) Press **Enter** to enable the Controller's Edit Mode and the flashing block becomes an underscore.

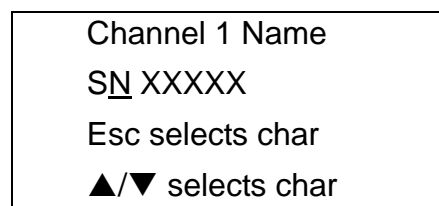

Fig 2-12 : Controller Edit Mode

- 5) Press the **Up** and **Down Keys** to step through the alphabet (upper- then lowercase), followed by a blank space and numeric values (0–9) until the desired character is displayed.

Channel 1 Name
 SE XXXXX
 Esc selects char
 ▲/▼ selects char

Fig 2-13 : Change Character

- 6) Press **Enter** to save the new character and advance the cursor to the next position.
- 7) Again scroll through the display using the **Up** and **Down Keys** until the desired character is displayed.
- 8) Press **Enter** to save the altered character.
- 9) Repeat the procedure until the desired **Sensor Name** has been entered into the display, then press **Enter** twice to exit this function and return to the normal display.

Channel 1 Name
 SENSOR NAME
 Esc selects char
 ▲/▼ selects char

Fig 2-14 : Sensor Name Change

Note:

*It is possible for more than one Analyzer to have the same Name. Duplicate **Sensor Names** may cause confusion when reviewing printed reports. Make sure each analyzer on a network has been assigned a unique Name.*

2.3 Hardware Installation

Once the TOC600 Analyzer system hardware components have been checked and initial software parameters setup, the Analyzer can be installed. Installation consists of:

- Mounting the components
- Providing the required plumbing, communications and power connections

2.3.1 C80 Controller Mounting

The C80 Controller can be positioned wherever it is convenient. The stand-alone unit is wall-mounted in an aluminum enclosure that is sealed against moisture and is splash-resistant. The wall-mount Controller is secured in place with a steel mounting bracket. A 3/4" nut clamp accommodates the adjustable panel thickness, which can range in depth from 1/8" to 1/2" (3.17 mm to 12.70 mm). Controller mounting dimensions are shown in [Figure 2-15](#).

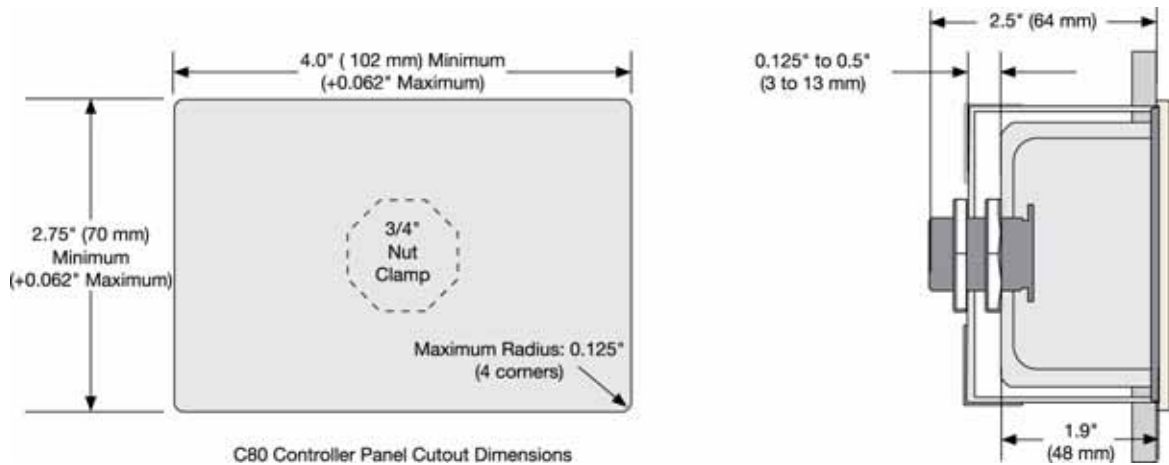

Fig 2-15 : Controller Mounting Dimensions

2.3.2 TOC600 Analyzer Mounting

The TOC600 Analyzer is a wall-mounted unit. They are splash-resistant but not waterproof and therefore should be installed in a dry and relatively dust-free environment (an optional NEMA 4 case is available). The air is filtered through an intake located on the bottom of the Analyzer. Do not allow the air flow through the intake or outlet filters on the bottom of the instrument to be obstructed or to get wet. If mounting the TOC600 outside, place it inside a water-tight enclosure and away from direct sunlight. Ambient air temperature should not exceed 40 °C (104 °F) and venting the enclosure may be necessary.

CAUTION:

Do not expose the TOC600 Analyzer to a caustic atmosphere, as may be present in a DI regeneration area or near an acid waste sump; exposure will corrode electronic circuitry and damage analysis components. If an Analyzer must be installed in a hazardous area, it must be protected by a suitable enclosure which complies with all instrument operating specifications. See "Specifications and Accessories" on page 181.

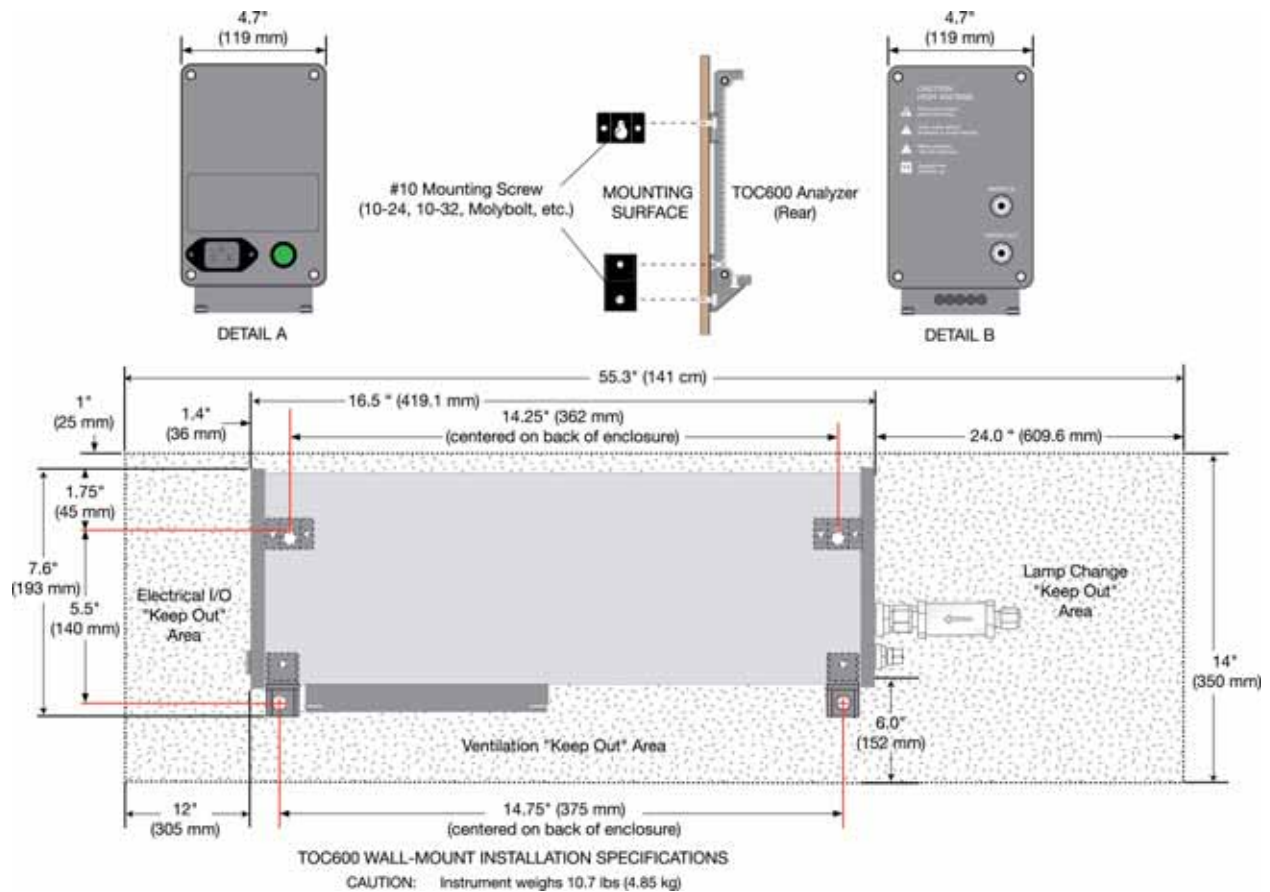

Fig 2-16 : TOC600 Analyzer Mounting Template

The TOC600 Analyzer is secured using two 1/4" mounting brackets located on the rear of the instrument in conjunction with two 1/4" tie-down tabs positioned along its bottom. The mounting dimensions for the Analyzer are shown in [Figure 2-16](#).

TOC600 Analyzers combine the measurement cell, requisite electronics and power supply into a single compact package that is designed to be splashproof and water-resistant. The case is constructed of lightweight aluminum.

2.3.3 Plumbing Connections

Sample connections are made through a 1/4" inlet (**WATER IN**) and a 1/4" outlet (**WATER OUT**) 316 stainless steel compression fitting located at the Water I/O end of the Analyzer enclosure. The sample inlet is fitted with a prefilter to minimize the potential for contamination. Plumbing the Analyzer consists of making these two connections and optionally installing an upstream isolation valve to permit control of sample flow to the instrument.

Isolation Valve Installation

TOC600 Analyzers should be connected to the sample supply through an upstream isolation valve in order to allow manual control of the input flow. The isolation valve must be supplied by

the customer. Hach Ultra provides a 1/4" tube x 1/4" MNPT stainless steel compression fitting that can be inserted in the valve to assist in connection to the Analyzer.

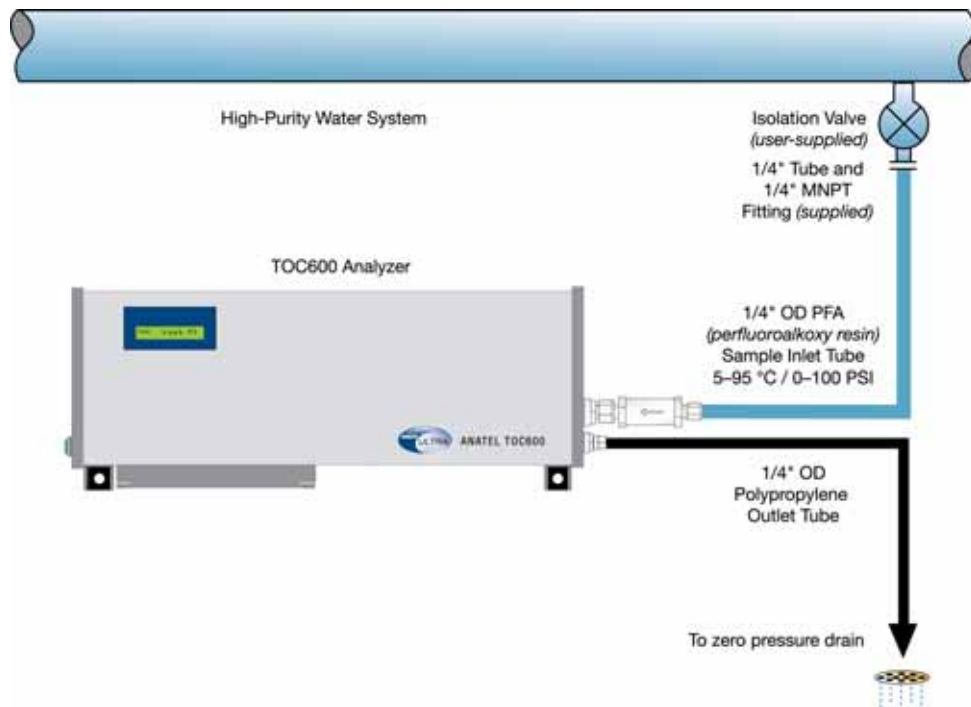

Fig 2-17 : High-Purity Water System

Bypass Valve Installation

To connect the optional system suitability/calibration system, install two three-way bypass valves:

- One in the sample supply line, upstream of the supply inlet filter assembly
- One in the outlet line

These two valves allow instrument calibrations, system suitability tests, and system validations to be performed. These three-way valves may be user-supplied or purchased as a kit from Hach Ultra, P/N FG1200750. Contact Customer Service at 800.866.7889 or +1-541.472.6500 to order.

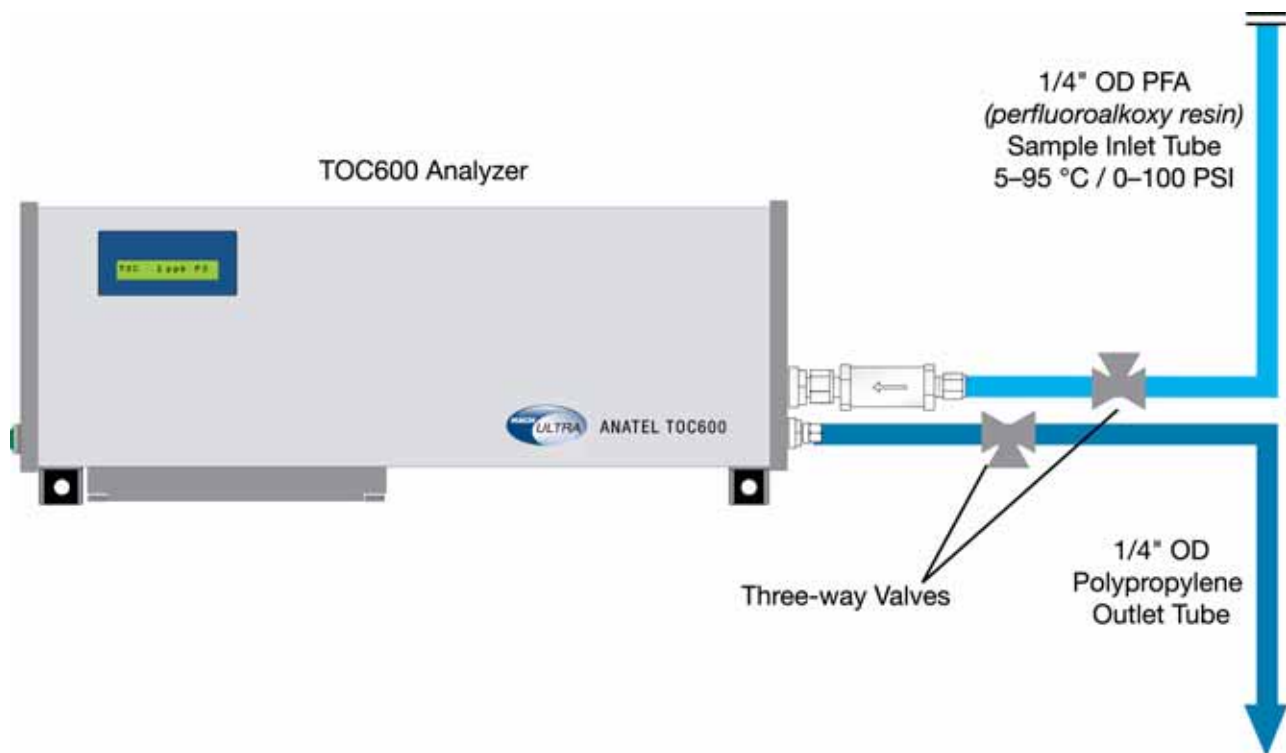

Fig 2-18 : Three-Way Bypass Valve Installation

Water I/O Tubing

A length of 1/4" perfluoroalkoxy resin (PFA) sample tubing and a length of 1/4" OD polypropylene drain tubing are supplied with each TOC600. The suitability of any sample tube to the sample temperature and pressure should be determined prior to plumbing the instrument. The PFA tubing provided is not recommended for installations where:

- The water temperature exceeds 75 °C (167 °F) and the pressure exceeds 90 psig (620 kPa).
- The water temperature exceeds 85 °C (185 °F) and the pressure exceeds 80 psig (550 kPa).
- The water temperature exceeds 90 °C (194 °F) and pressure exceeds 70 sag (480 kPa).

Under these flow conditions, or in any application where the use of PFA is a concern, use of a high-grade 1/4" (OD) PTFE, FEP, PVDF or 316 stainless steel sample tube is recommended.

CAUTION:

Install the 15 Micron Filter on the Inlet Port prior to making water I/O connections.

A 9/16" wrench is needed to install the tube fittings. Connections are made as follows:

- 1) Flush the customer-supplied isolation valve and any three-way valves by opening and closing them *fully* several times before connecting the Analyzer in order to avoid introducing debris through the inlet plumbing.

- 2) Noting its flow direction, connect the 15 micron inlet filter to the **WATER IN** port of the Analyzer.
- 3) Push one end of the PFA inlet tubing into the rear of the inlet filter assembly until it cannot be inserted any farther. Be careful not to crimp or damage the tubing.
- 4) Hand-tighten the compression nut taking care not to pull on the tubing.
- 5) Mark both the compression nut and the **WATER IN** connector as a reference for tightening the nut.
- 6) Tighten the compression nut 1-1/4 turns to secure the connection.

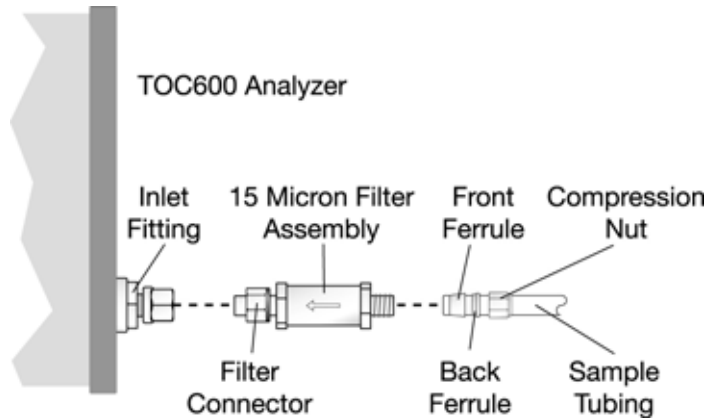

Fig 2-19 : TOC600 Analyzer

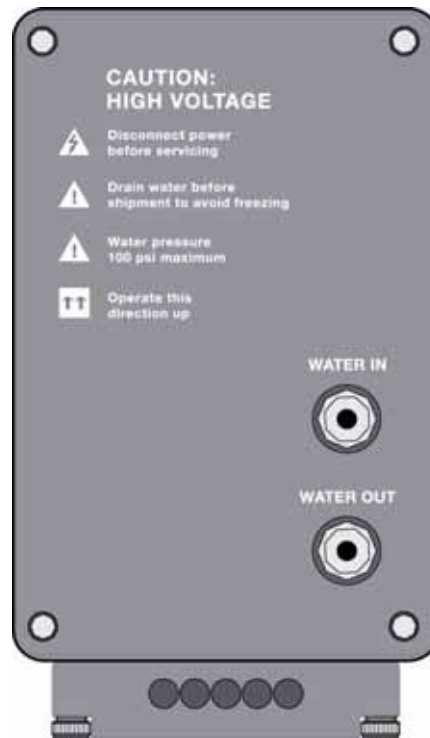

Fig 2-20 : TOC600 Analyzer Water I/O Connections

- 7) Repeat [step 2](#) through [step 5](#) to attach the 10-foot 1/4" OD polypropylene drain tubing to the **WATER OUT** port. Run the open end to a gravity feed drain.

CAUTION:

The drain must be open (without suction or pressure).

- 8) Make sure the sample vessel is installed and securely tightened on the calibration assembly.
- 9) Leak test the connections by slowly opening the upstream isolation valve to introduce water into the instrument. Pulse the valve several times by opening and closing it, then recheck the fittings.
- 10) If necessary, slowly tighten the compression fittings to stop any leaks.

CAUTION:

Once a new ferrule has been "swaged" by tightening it 1-1/4 turns, it should be tightened only another 1/8- to 1/4-turn to seal the connection: overtightening the fittings may damage or crush the ferrules and cause leaks.

2.3.4 Communications Connections

Communications are established by making the necessary connections between a TOC600 and its associated C80 Controller. The 3-foot local cables, twin BNC tee connectors, passive terminators and 10-foot trunk cable were all checked during the verification procedure and should only have to be reconnected in order to establish communications. The cable's twist-

lock fittings facilitate the quick and easy connection and disconnection of the analyzer for installation, relocation or repair.

The C80–TOC600 Analyzer interface must be configured as a single trunk line with local cabling no longer than three feet in length, although the trunk line can extend a total of 3000 feet (not including local cable drops).

Note:

Trunk cabling longer than 500 feet requires active termination. In these longer installations, an AC-powered terminator (PN FG2006501 – 120VAC, FG2006601 – 230VAC) must be connected to the open coupling at one end of the cable, then plugged into an appropriate AC source. A passive terminator should be installed on the other end of the trunk cable.

If electrical interference may be a problem, the interface cable should be installed in conduit which is free from other wiring or AC buses. Active (AC-powered) termination is required for trunk lines longer than 500 feet in order to control noise and provide a clean communications signal.

To establish interface communications between the C80 Controller and the TOC600 Analyzer:

- 1) Grasp the end of the 3-foot local cable attached to the C80 Controller and, noting the alignment of its internal pins, gently push it onto the middle coupling of the tee connector. Twist the cable onto the connector until it “locks” on the coupling.
- 2) Similarly fasten the Analyzer to its tee connector.
- 3) Link the two tee connectors using the section of trunk cable.
- 4) The passive terminators (P/N FG2005901) provided with each System component should be fastened to the open coupling at each end of the trunk cable.

Auxiliary Inputs and Outputs

All of the Analyzer's auxiliary input and output connections are made on its integral I/O Connector Block. This standardized Connector Block provides a consistent and flexible means of interfacing the TOC600 Analyzer with a variety of other devices. External wiring connections are made by removing the entire I/O Connector Block from the bottom of the Analyzer and wiring each I/O cable to the appropriate screw terminals. The connector type and gender of the other end of the cable is determined by the auxiliary device to which it is attached.

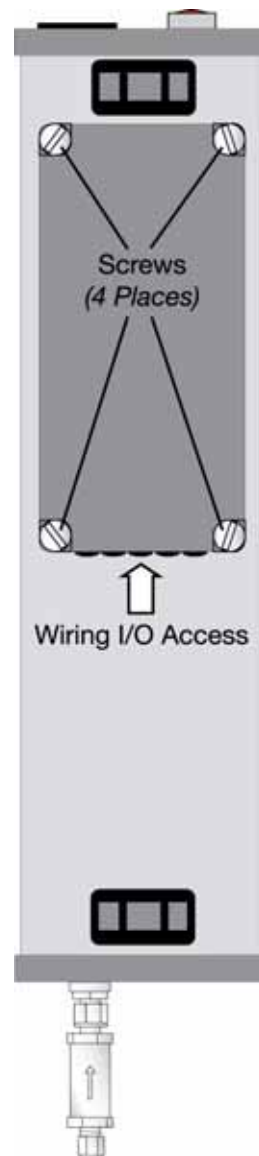

Fig 2-21 : TOC600 Analyzer: Bottom View

I/O connections require a Phillips-head and small flathead screwdriver and are made as follows:

- 1) Make sure the Analyzer is turned **OFF** and disconnected from its power source.
- 2) Remove the I/O Connector Block from the bottom of the TOC600 Analyzer analyzer by loosening the four retaining screws. A medium flat blade screwdriver may be required.
- 3) Loosen and remove the two screws that secure the metal strain relief plate.
- 4) Feed the device wiring through one of the holes at the end of the I/O Connector Block cover and along the corresponding slot in the foam padding.

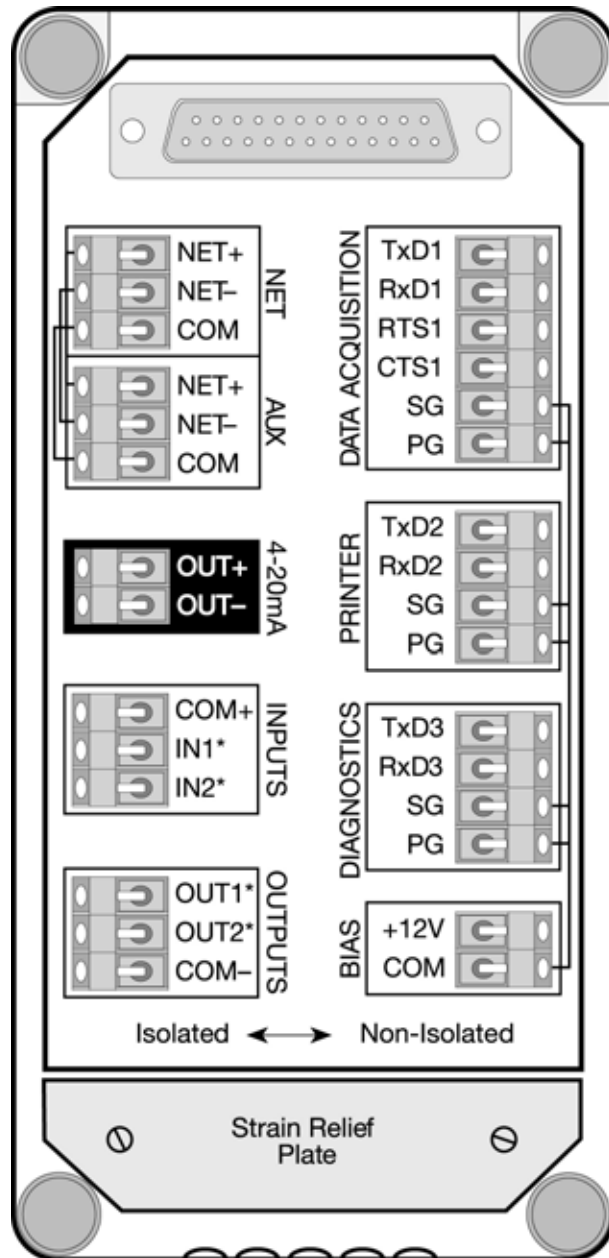

Fig 2-22 : Connector Block

- 5) Make the connections to the appropriate terminals. Refer to the following Sections for detailed information on the specific interface:
- “Printer Output” on page 109
 - “Analog Outputs” on page 119
 - “Digital Inputs and Outputs” on page 137
 - “12 VDC Bias Output” on page 141
 - “Serial Communications” on page 145

- 6) Replace the metal strain relief plate.
- 7) Replace the I/O Connector Block on the bottom of the Analyzer, taking care not to pinch any wires, and secure it in place by tightening the screws.

A Connector Block provides connections between the Analyzer's electronics and the I/O Connector Block. The I/O Connector Block offers the input and output connections listed in [Table 2-2](#) and [Table 2-3](#).

Table 2-2 : Isolated I/O Connections

These connections are optically isolated from ground and the Analyzer's internal power to avoid potential problems.	
NET	Used for TOC600 Analyzer Network connections via the twinaxial BNC cable. The C80 Controller and the TOC600 are supplied with a 3-foot length of local Anet cable.
AUX	Reserved for Hach Ultra use.
4-20mA	Furnishes a 4-20 or 0-20 mA output proportional to the Analyzer's TOC reading for external analog devices.
INPUTS	A digital connection allowing limited supervisory control of the Analyzer by a remote device or switch. Connecting to the "IN1*" terminal allows external initiation of a TOC analysis cycle; "IN2*" determines whether the Analyzer is in the Auto TOC or the Purge Mode.
OUTPUTS	Provides a corresponding digital output for devices such as a remote alarm indicator or a PLC (Programmable Logic Controller). Connecting to the "OUT1*" terminal reports on whether the Analyzer's TOC level is above or below the user-specified limit; "OUT2*" reports whether its sample valve is opened or closed. Alternatively, "OUT2*" can be set to report the status of the Uncompensated Conductivity Alarm.

Table 2-3 : Non-Isolated I/O Connections

DATA ACQUISITION	Bidirectional RS-232C interface that permits the Analyzer to interface with serial devices such as a host computer.
PRINTER	Outputs data to a local thermal or serial printer to generate hardcopy reports.
DIAGNOSTICS	A secondary RS-232C port for reporting resistivity and temperature in a 4-20 mA format via an external DAC (Digital-to-Analog Conversion) Module. This interface also may be used by Anatel Service Department personnel, eliminating the need to disconnect other wiring in order to perform field service procedures.
BIAS	Furnishes 12 VDC, 0.5 Amp power for biasing digital inputs and outputs to drive external devices like the auxiliary External DAC Modules.

2.3.5 Power Connections

AC Power for each TOC600 Analyzer Analyzer is provided via its IEC 320 power receptacle and molded power cord. The cord plugs into a standard AC power source (see ["Specifications and Accessories" on page 181](#) for specific requirements). The Analyzer's internal electronics are self-adjusting to accommodate a 100 VAC to 240 VAC supply, 50 or 60 Hz at 30 W. The

C80 Controller receives its 9 VDC power through an Hach Ultra-supplied transformer that connects to a 120 VAC adapter. A 230 VAC version of the adapter also is available.



WARNING

Use the grounded power cord provided. Do not clip the ground pin. Removing the ground pin violates electrical safety requirements.



WARNING

This equipment is fused for only a single ungrounded (hot) mains connection. Do not connect this equipment to mains circuit with two ungrounded (hot) mains connections, such as a N-American 220V mains circuit.

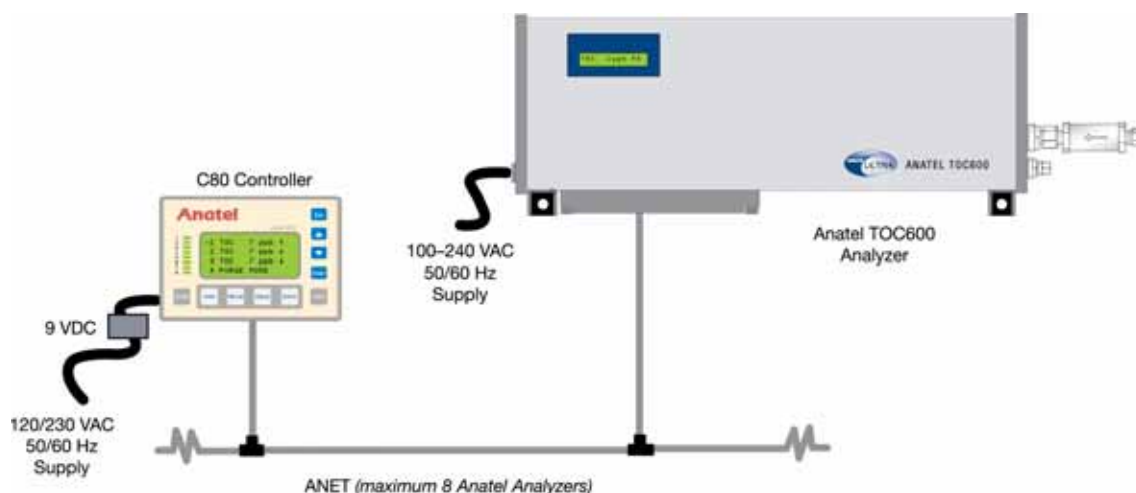

Fig 2-23 : Anet (maximum 8 Analyzers)

2.4 Analyzer Initialization

With the plumbing, communications and power connections properly established, the TOC600 Analyzer can be initialized and placed into operation. Because the cleanliness of commercially available tubing varies (particularly stainless steel), it is suggested that the Analyzer's plumbing be thoroughly flushed. This is accomplished by placing the instrument in the Self-Clean Mode for several hours.

To initialize the TOC600 Analyzer:

- 1) Open the optional isolation valve to initiate flow to the Analyzer.
- 2) Turn the Analyzer and any attached printer **ON**. The instrument initially conducts a series of self diagnostic routines, shown by a green Controller LED, to verify that it is operating properly. The LED flashes red while the Controller establishes communications with its associated Analyzer.

The Controller reports if it is unable to establish communications with the Analyzer and suggests checking the wiring connections. Once the Controller has established

communications, any other faults detected during the power-up diagnostics may be examined by pressing the **Alarm Key**. Summaries of any problems encountered are displayed and output to the printer; refer to “[Alarm Codes](#)” on page 165 for information on reported Alarm Codes and their possible indications. When its self-diagnostics have been completed successfully, sample flow begins and the Analyzer initiates an automatic analysis cycle based on factory default parameters. If there is no flow through the instrument, check the isolation valve and the three-way valves.

- 3) Press the **Manual Key** in order to access the Analyzer’s **Manual Menu**.

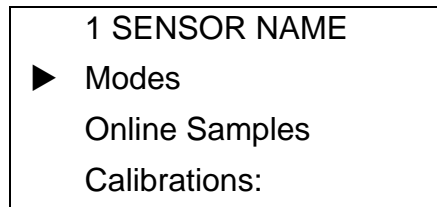

Fig 2-24 : Manual Menu

- 4) Select **Modes**, then press **Enter** to access its submenu.

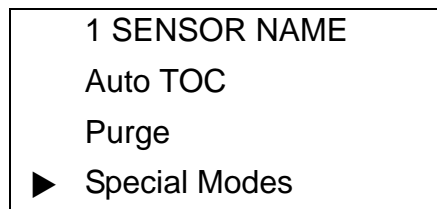

Fig 2-25 : Modes Menu

- 5) Specify **Special Modes** and press **Enter** to display the available options.

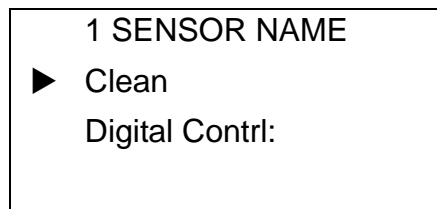

Fig 2-26 : Special Modes Menu

- 6) Use the **Up** and **Down Keys** to specify **Clean**.
- 7) Press **Enter** to place the TOC600 Analyzer in its Self-Clean Mode of operation, then press **Esc** twice to return to the normal display.

CLEAN MODE is displayed on the Controller's LCD for the TOC600 Analyzer. In this mode, the Analyzer's UV lamp is turned on to oxidize any contaminants inside its measurement cell and sample water flows through the instrument to flush away impurities. Allow the Analyzer to run in this state for 3 to 4 hours, longer if the sample tube is lengthy or if the sample point is at low pressure, such as a gravity-feed tube.

- 8) With the TOC600 Analyzer sufficiently cleaned, automatic TOC analysis can be initiated. Press the **Menu Key** to access its Manual Mode.
- 9) Specify Modes once again and press **Enter**.

Note:

For accurate results after initial installation or long-term storage, allow the instrument to complete several analyses before accepting the reported data as valid.

- 10) Specify **Auto TOC** and press **Enter** to initiate automatic analysis based on the factory default parameter settings.
- 11) Press **Esc** repeatedly to return to the top-level Controller display.
- 12) With the instrument selected, press **Print** to access its submenu.

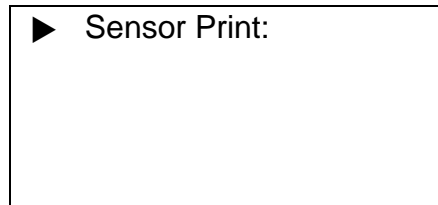

Fig 2-27 : Print Menu

- 13) Specify **Sensor Print** and press **Enter**.
- 14) Select **Printouts** and press **Enter** once again.

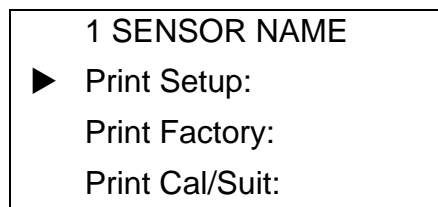

Fig 2-28 : Printouts Menu

- 15) Specify **Print Setup** then press **Enter** to generate a hard copy record of the instrument's current operational parameters.
- 16) Press **Esc** repeatedly to exit this function and return to the normal display.

3 Network Installation

3.1 General Information

As many as eight sensors and eight controllers can be networked together in any configuration to create a diverse combination of TOC600 Systems. A single TOC600 may be linked to eight separate controllers. Regardless of the instrument combination, the Anet must consist of at least one C80 Controller and one S10 Sensor.

3.2 Software Setup

Each TOC600 component must have its own unique address to identify it on the Network. Sensors are assigned Channel ID Numbers that correspond to the LEDs on the faceplate of their associated Controller. C80 Controllers are assigned Network addresses.

It is recommended these assignments be made during Operational Verification as described in [“Operational Verification” on page 16](#) before performing hardware installation of the Network. This process avoids conflicts and assures all of the components on the Network are uniquely identified and functioning properly.

3.2.1 ID to S/N Cross Reference

Default: Channel 1

The ID to Serial Number Cross-Reference associates each analyzer's Channel ID with its designated Serial Number. A Channel ID Number (1-8) is used to identify each analyzer for display and reporting purposes, as well as serving as its Network address. The attached Controller determines these ID-S/N relationships when it first scans the Anet. These ID-SN assignments may be altered, but duplicate Channel IDs are not permitted on the Network.

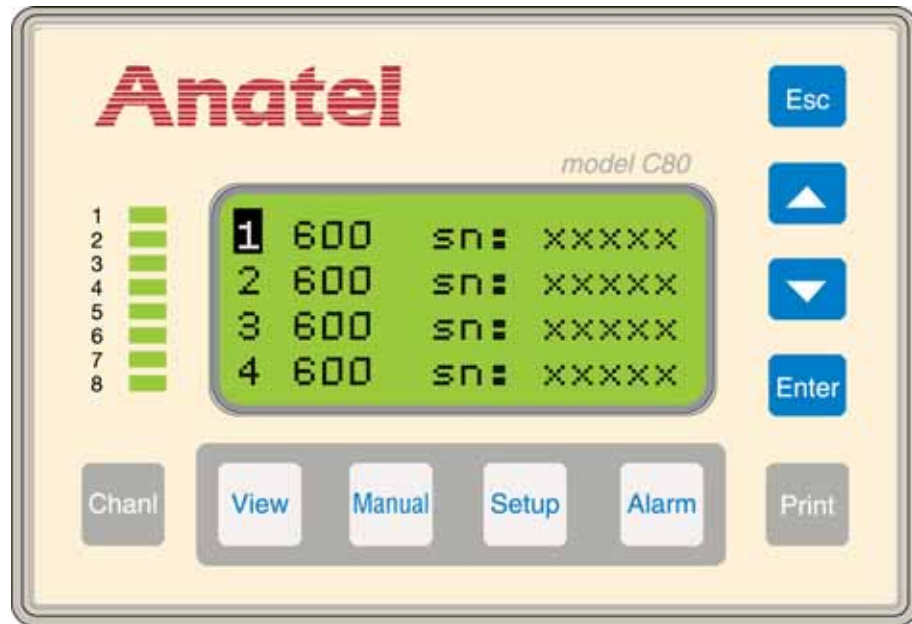

Fig 3-1 : ID to Serial Number Cross-Reference Screen

To make Channel ID–Serial Number assignments:

- 1) With any TOC600 selected, press the **Setup Key** to display its menu selections.

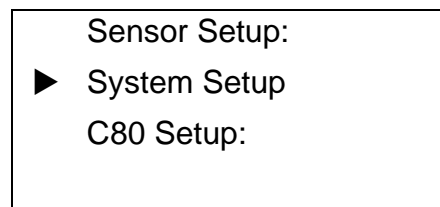

Fig 3-2 : Sensor Setup Selections

- 2) Use the **Up** and **Down Keys** to specify **System Setup**.
- 3) Specify **ID to SN Xref** and press **Enter** to view its parameter screen. The Channel ID–Serial Number assignments are presented and Channel #1 flashes to indicate that it is the current selection.
- 4) Accept this ID-S/N cross-reference, or press **Enter** to access the Controller’s Edit Mode. The flashing block cursor becomes an underscore.

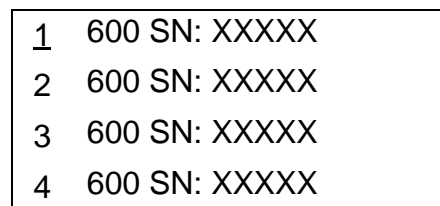

Fig 3-3 : Controller Edit Mode

- 5) Use the **Up** and **Down Keys** once again to select the Channel ID Number that corresponds to the associated analyzer's Serial Number. Note that duplicate Channel IDs are permitted while in the Edit Mode, but they cannot be saved.
- 6) Press **Enter** to retain the new ID Number and advance the cursor to the next analyzer.
- 7) Repeat the procedure to reassign other Channel IDs as necessary. The **Up** and **Down Keys** are used to access other Channel IDs that are not presently visible in the display.
- 8) With all of the Channel ID–Serial Number cross-reference assignments established, press **Esc**. A message is posted indicating that the Network will be reset in order to implement the changes. If duplicate Channel IDs exist, a message is displayed indicating this condition is not permitted and that the ID–S/N conflict must be resolved before the screen can be exited.
- 9) Press **Enter** to continue and the Controller resets the Network. The Channel LEDs and displays reflect the new ID to S/N assignments.
- 10) Press **Esc** repeatedly to exit this function and return to the normal display.

3.2.2 Controller Address

Default: Address 9

Each C80 Controller also must have its own unique address on the Network for identification and reporting functions. The Sensor address is pre-configured at the factory to a default of "9," but may have to be changed in order to avoid a Network conflict.

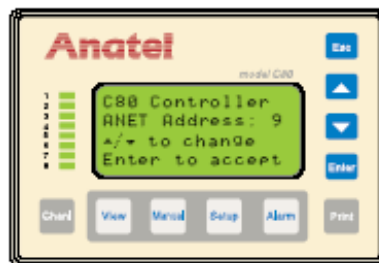

Fig 3-4 : Controller Address Screen

To change the Controller's Anet address:

- 1) While holding the **Setup Key** down, cycle the Controller's power by removing, then restoring, its power connection. The Controller displays its current address.
- 2) Use the **Up** and **Down Keys** in order to scroll the Controller's **Anet Address** to the desired setting (9–16).
- 3) Press **Enter** to retain the displayed setting and return to normal operation.

3.3 Network Setup

The Anet Network is configured by making the necessary communications connections between multiple Sensors and their managing Controller(s) using the shielded twin-axial cabling. The cable's BNC twist-lock fittings allow quick and easy connection and disconnection of any component without disrupting overall network operation.

The Anet Network must be configured as a single trunk line with each analyzer connected through an individual tee connector using a local cable no longer than 3 feet. The Anet trunk line can extend a total of 3000 feet not including these local cable lengths. If the trunk line exceeds 500 feet, its cable should be installed in conduit which is free from other cables or AC buses to prevent the potential for electrical interference.

To establish Anet communications:

- 1) Grasp the end of the 3-foot local cable attached to a C80 Controller and, noting the alignment of its internal pins, gently push it onto the middle coupling of the tee connector. Twist the cable onto the connector until it “locks” on the coupling.
- 2) Similarly fasten the local cable that extends from the other A-1000 Network components to their respective tee connectors.
- 3) Link the various tee connectors using sections of twin-axial trunk cable.
- 4) Both ends of the Network must be terminated to control noise and help ensure a clean signal. The passive terminators (*P/N FG 2005901*) provided with each component should be fastened to the open jack connector at each end of the Anet Network with a total trunk length less than 500 feet.

Table 3-1 : Potential Anet Configurations

C80 Controller	TOC600 Analyzer
8	8
0	0
1	1
1	2
2	3
:	:
<ul style="list-style-type: none"> • Maximum of eight C80 Controllers • Maximum of eight TOC600s 	

Anet Networks longer than 500 feet require active termination. In these installations, an AC-powered terminator (*P/N FG2006501: 120 VAC, 60 Hz; FG2006601: 230 VAC, 50 Hz*) must be connected to the open coupling at each end of the Network and then plugged into an appropriate AC supply to ensure a clean signal. More analyzers may be added to an existing Anet configuration by positioning them along the trunk line and then attaching them as described above using the twin-axial cable and the tee connector provided.

Note:

It is recommended that once the Network communications have been established with all instruments, the System Time be again set as described in “System Time” on page 18. The date and time are then broadcast to the connected Sensors, thereby assuring that all of the instruments on the Network are synchronized to the same clock setting.

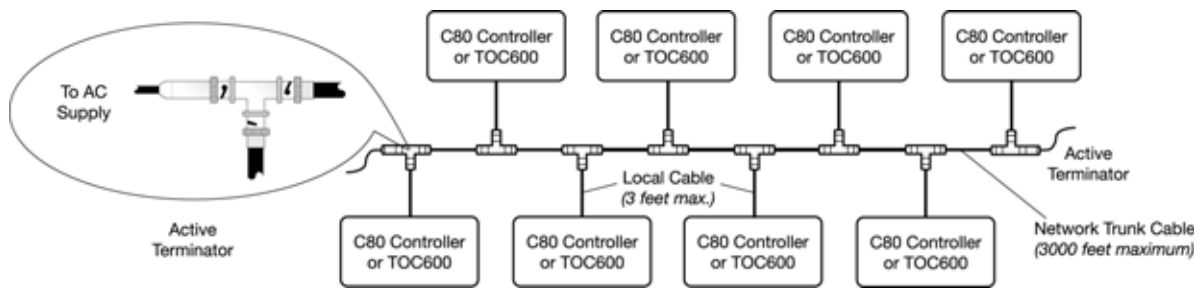

Fig 3-5 : Anet Communications Connections

3.3.1 TOC600 Network Connections

The local cable must be attached to a TOC600 when connecting it to the network. This 3-foot communications cable is provided with each analyzer and can be found in its installation kit. The TOC600 Analyzer is shipped with the local 3 ft. Anet cable already installed.



WARNING

Always disconnect the instrument from its power source before attempting to access internal components. Failure to do so may result in electrical shock.

Network connections are made to the NET Port on the Sensor's I/O Connector Block as follows:

- 1) Turn the analyzer **OFF** and disconnect the power cord from its source.
- 2) Remove the I/O Connector Block from the bottom of the analyzer by loosening the four thumbscrews.
- 3) Loosen and remove the two Phillips-head screws that secure the metal strain relief plate.
- 4) Feed the interface wiring through one of the five holes at the end of the Connector Block cover and along the corresponding slot in the foam padding.
- 5) Make the necessary connections to the analyzer's **NET** port as shown in [Figure 3-6](#).

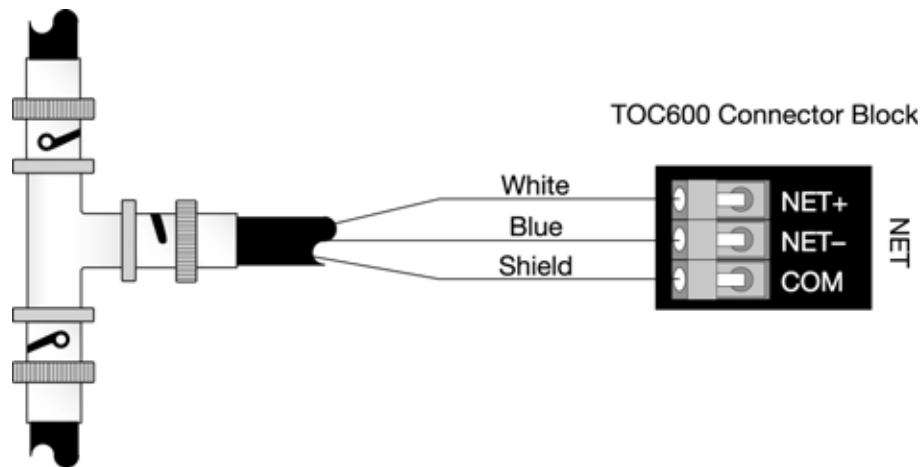

Fig 3-6 : Sensor NET Port Connections

- 6) Replace the metal strain relief plate.
- 7) Replace the I/O Connector Block on the bottom of the analyzer, taking care not to pinch any wires, and secure it in place by tightening the thumbscrews.

CAUTION:

The I/O Connector Block must be reinstalled correctly to conform to emissions specifications.

- 8) Reconnect the power cord and turn the unit **ON**.

4 C80 Controller Setup

4.1 General Information

The C80 Controller provides the user interface with the various Analyzers, furnishing data displays and access to individual TOC600 Analyzer parameters. The Controller is a stand-alone unit.

User interaction with the C80 Controller is through a consistent interface. Its 4-line by 16-character display affords full functionality for interacting with its associated TOC600 Analyzers, allowing the user to manage their operation individually.

4.2 C80 Controller

The C80 Controller display simultaneously provides data from multiple Analyzers. The Controller's faceplate also contains a set of Channel ID LEDs which reflect the operational status of each connected Analyzer and ten membrane keys for user interaction.

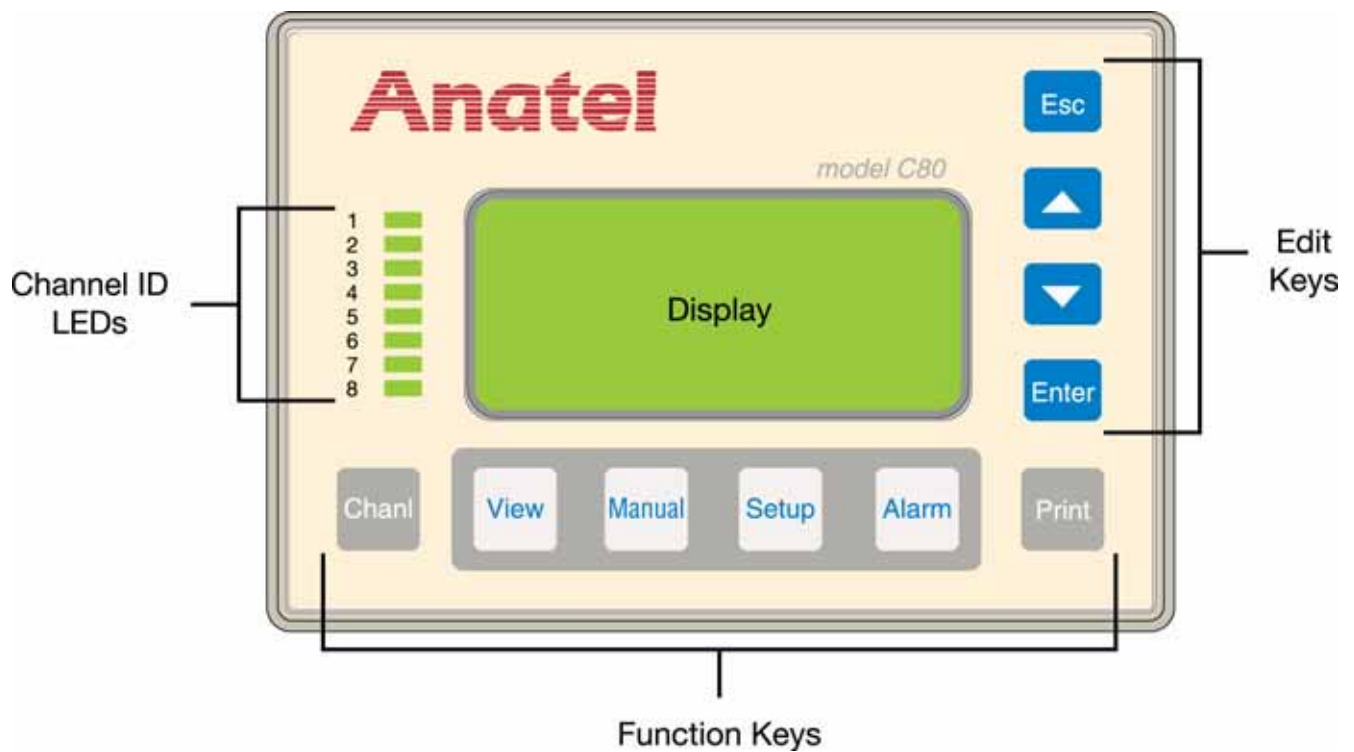

Fig 4-1 : C80 Controller Display

The C80 Controller's Edit Keys perform the following operations:

Esc	Exits the current screen or mode and returns to the previous one—any changes are saved.
Up and Down	Scrolls to specify menu items and parameter values for selection. The “Up” arrow key moves the cursor up or left within the display and increments numbers while the “Down” arrow moves the cursor down or right and decrements numbers.
Enter	Chooses the indicated menu selection, saves a modified value, accesses the Edit Mode or moves the Edit Cursor to the next selection.

The Controller's Function Keys may be pressed at any time to access the designated TOC600 Analyzer's operations:

ChanI	Displays identification and status information on the selected Analyzer.
View	Toggles between a Multichannel and a Single Channel View.
Manual	Accesses the operational Mode options for the chosen Analyzer.
Setup	Accesses global variables for the entire TOC600 Analyzer System as well as operational parameters for individual Analyzers.
Alarm	Acknowledges and displays any TOC600 Analyzer excursions or System alarms.
Print	Allows on-demand printouts to be generated in several formats.

4.3 Operational

Each Analyzer's parameter values and operational settings are accessed through menu selections. The Multichannel and Single Channel Views represent the highest level Controller screens; a parameter screen is the lowest level display. It presents the current value for the particular variable, allowing it to be edited.

There are a few general rules that govern the C80 Controller interface:

- The **Up** and **Down Keys** are used to specify a menu item: it then is selected by pressing the **Enter Key**. A menu item that is followed by a colon (:) indicates that a subordinate screen exists.
- An arrow (“▶”) indicates the currently selected menu item; a check (“✓”) preceding an item indicates that it is the currently active menu selection.
- An “X” in instrument display and printout examples represents any number or character.
- While an Edit Mode is employed to change TOC600 Analyzer parameter values, there is no temporary screen. All parameter changes are made in real time and the displayed values are those that are saved. Pressing **Enter** advances to the next parameter: **Esc** exits to the previous screen.
- Any changes made to an Analyzer's parameters are immediately output to a local printer, but they do not take effect until the subsequent analysis cycle.

4.4 Contrast Adjustment

Once it has been installed, the contrast level of the Controller's background may have to be adjusted to make its display more easily visible under the ambient lighting conditions. This Controller display adjustment is found in the **System Setup Menu**.

To adjust the Controller's display contrast:

- 1) With any Channel View displayed, press the **Setup Key** and its menu selections are presented.
- 2) Use the **Up** and **Down Keys** to specify **C80 Setup**.

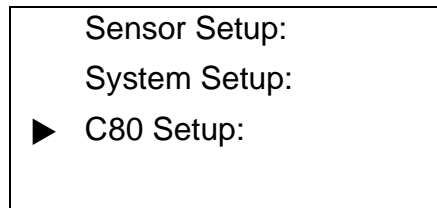

Fig 4-2 : C80 Setup Selections

- 3) Press **Enter** to access its submenu.

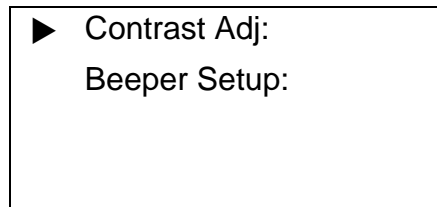

Fig 4-3 : C80 Setup Submenu

- 4) Specify **Contrast Adj** and press **Enter** once again to display its parameter screen.
- 5) Use the **Up** and **Down Keys** to lighten or darken the display as necessary.
- 6) With the contrast set to the desired level, press **Esc** three times to return to the normal display.



Fig 4-4 : C80 Contrast Adjustment Screen

4.5 View Options

The **View Key** determines the type of TOC600 Analyzer information that is presented in the Controller's LCD display. Two data display formats are offered:

- 1) Detailed readings for a single Analyzer including the current TOC, trend, profile type, conductivity (or resistivity), and temperature values.
- 2) A multichannel listing of all Analyzers connected to the Controller, their respective TOC values and current trend. The Analyzer's alternate operational modes (**PURGE** or **CLEAN**) also are reported.

Repeatedly pressing the **View Key** cycles through these display formats. All displayed values are the result of the TOC600 Analyzer's previously completed analysis cycle. These readings are updated at the conclusion of each cycle.

Simultaneous access to a particular Analyzer is not permitted with a multi-user network, such as when multiple C80 Controllers are connected to the same Analyzer. In the event a concurrent attempt is made to modify an Analyzer (through another Controller), the conflict is reported and access is denied to the second device. Press the **Esc Key** to return to the original menu.

Access denied --
another user has
current access
to this Sensor

Fig 4-5 : Access Denied Message

4.5.1 Single Channel View

Detailed analysis data are available for each of the connected Analyzers through the Controller's Single Channel View. To examine an individual instrument's data, specify the TOC600 Analyzer and then press the **View Key** until the Single Channel format is displayed.

The first line of the display identifies the instrument by its Channel ID number and user-entered name. The remaining lines furnish the following information on the Analyzer's previous analysis cycle:

- Line 2 TOC concentration in ppb
- Line 3 Trend of the Analyzer's TOC level averaged over the last hour, preceded by a "+" or "-" to indicate its direction. In addition, the Profile Type of the sample is reported as "P1," "P2" or "P3" (see ["Auto TOC Mode" on page 57](#) for an explanation of Profile Types).
- Line 4 Sample conductivity (or resistivity) and water temperature, in degrees Centigrade.

The individual readings for the other Analyzers associated with this Controller can be observed by pressing the **Up** and **Down Keys**.

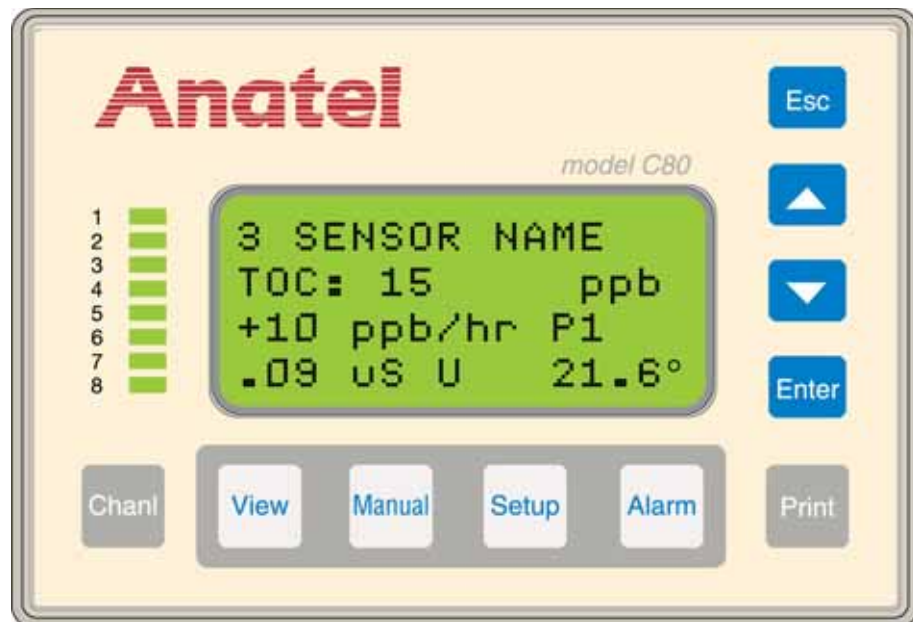

Fig 4-6 : Single Channel View

4.5.2 Multichannel View

Multichannel is the initial default view when a C80 Controller is managing more than one instrument. This network display affords a summary listing of all its associated Analyzers to provide an overview of several aspects of the monitored process. To examine multiple channel data, press the **View Key** until that display format is presented.

The Multichannel View lists each Analyzer by its Channel ID and reports its respective TOC value, calculated at the conclusion of its last analysis cycle. The value is followed by a “↑” or “↓” to indicate the directional trend in TOC level for that Analyzer based on its running average over the last hour. This trend indication initially appears at the conclusion of the instrument’s second analysis cycle. If no direction is denoted, the TOC level has not changed over the trend period. When the Analyzer is under remote digital control (see “[Software Setup](#)” on page 138), *r/c* is also displayed to report this condition.

PURGE MODE indicates that sample water is flowing through the corresponding instrument’s measurement cell, but no TOC analysis is being conducted (conductivity, however, is reported). In the **CLEAN MODE**, the Analyzer’s UV lamp is turned on to oxidize any residual organics while the water sample flows through its measurement cell.

The Multichannel listing can be scrolled in order to view any connected instruments that are not visible within the Controller’s four-line display by pressing the **Up** and **Down Keys**.

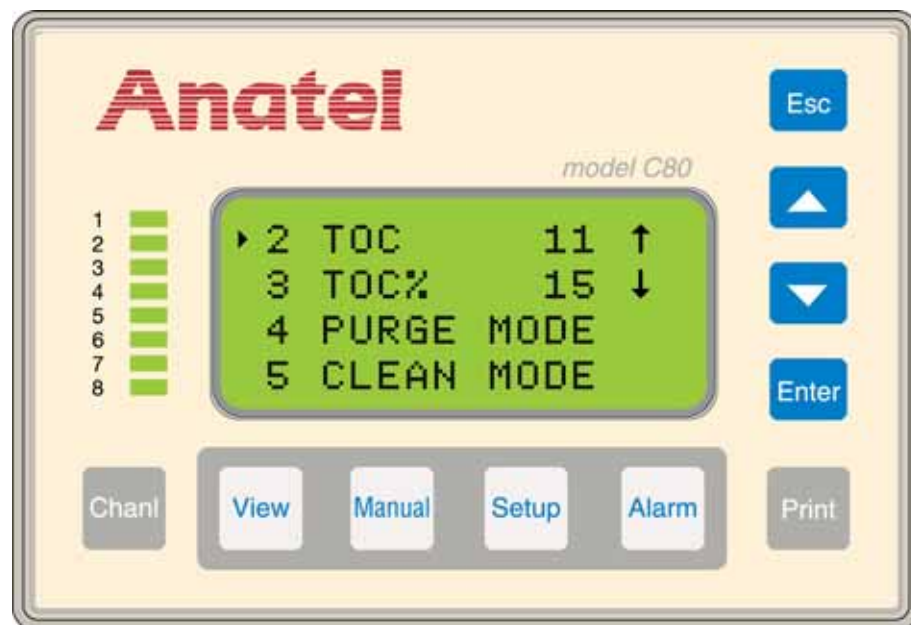

Fig 4-7 : Multichannel View

4.5.3 Channel Display

The **Chanl Key** furnishes general information about the instrument including its Model and Serial Number, operational mode and current state.

These Channel data are accessible either from the Single Channel View, or by using the **Up** and **Down Keys** to identify the desired Analyzer in the Multichannel View and then pressing **Chan1**. The four lines of data presented in the Channel Display are:

- Line 1 Instrument's Channel ID Number and user-entered Name.
- Line 2 Analyzer Model and Serial Number.
- Line 3 Analyzer's current operational Mode.
- Line 4 Analyzer's current operational State.

This information may be examined for other associated instruments simply by pressing the **Up** and **Down Keys** once the Channel display is presented.

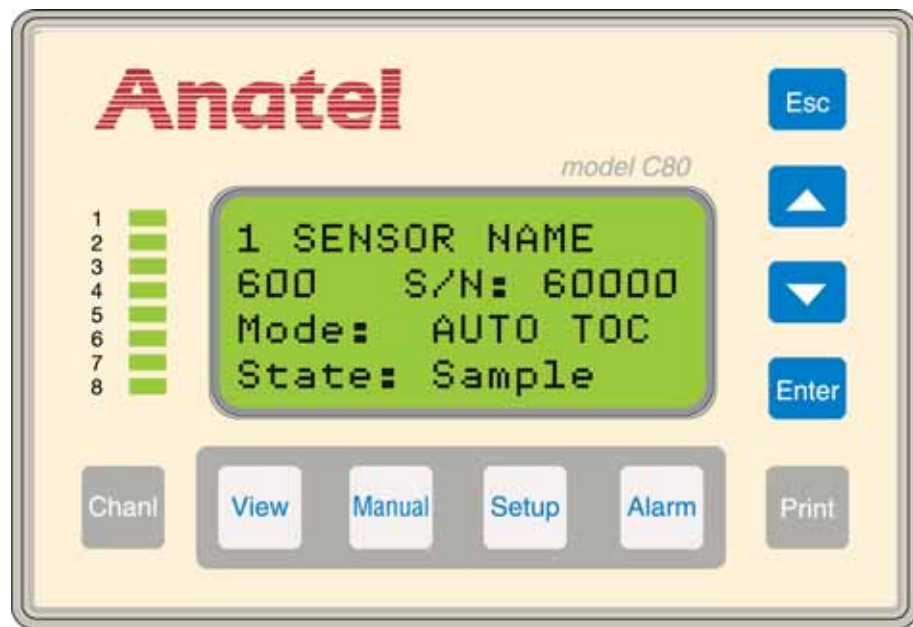

Fig 4-8 : Channel Display

Pressing the **Chan1 Key** twice displays the checksum value of the instrument's controlling EPROM as well as its current firmware version. This ROM checksum is calculated each time the instrument is powered-up and is the same value that would be produced by a device programmer. The checksum value and firmware version are also available on the Factory Configuration printout (see ["Printouts" on page 114](#)).

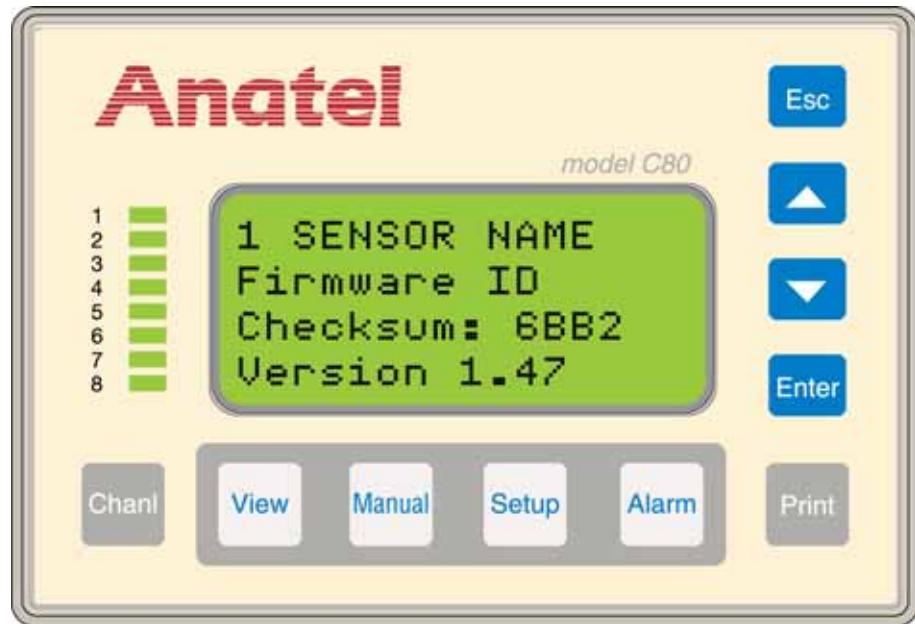

Fig 4-9 : Checksum Display

5 TOC600 Analyzer Setup

5.1 General Information

Once they have been installed, TOC600 Analyzer Analyzers can begin analysis immediately based on the factory default parameters. The user can selectively alter these default values to tailor the instrument's operation to the requirements of the particular application when the TOC600 is used with a C80 Controller.

TOC600 Analyzer Analyzers run in one of three data-gathering modes:

Auto TOC	Standard operational mode for monitoring any high-purity water system. In this mode, the instrument automatically performs successive TOC analyses and reports the results until the cycle is interrupted by the user.
Purge Mode	Opens the Analyzer's internal sample valve, allowing sample water to flow through the instrument and flush the measurement cell. Conductivity (or resistivity) and temperature readings are reported.
Manual Mode	Allows the user to interrupt automatic operation and manually initiate an analysis cycle.

Appropriate printouts are produced on a local printer. Parameter changes, limit excursions or any problems detected during operation automatically generate a printout to provide a hard copy record of the event. On-demand data printouts are available through the **Print Key** (see ["Auto TOC Mode Printout" on page 68](#)).

5.2 Factory Defaults

TOC600 Analyzers are shipped from the factory equipped with a set of default parameter values so that they can generate data as soon as they have been installed and powered up. A list of the Analyzer's current parameter settings is available through the **Print Setup** menu selection (see ["Printouts" on page 114](#)). The TOC600 Analyzer's factory default values are shown in [Table 5-1](#).

Table 5-1 : Factory Defaults

Identification	
Sensor Name	Serial Number
Channel ID Number	1
Analysis	
Sample Time	00:01:00 (hh:mm:ss)
Cycle Time	00:00:00 (hh:mm:ss)
Sampling Mode	Water Saver
User TOC Slope	1.000
User Conductivity Slope:	1.000

Table 5-1 : Factory Defaults

Outputs	
mA Range:	4 to 20mA
TOC Zero-Scale:	0 ppb
TOC Full-Scale:	1000 ppb
Conductivity Zero-Scale:	0 μ S/cm U
Conductivity Full-Scale:	20 μ S/cm U
Temperature Zero-Scale:	5 °C
Temperature Full-Scale:	95 °C
Activate External DAC:	No (Inactive)
DAC Error Output:	Minimum Output
DAC Calibration Output:	Inactive
Digital Control:	Disabled
Active Alarm Setup:	TOC Alarm
TOC Alarm Limit:	0500 ppb
Alarm Beeper:	Enabled
Supervisor & Operator Passwords:	00000 (Disabled)
Resistivity/Conductivity Units:	uS/cm U
Log Setup:	Data & Audit
TOC Print Interval:	Continuous
% Change in TOC	1 percent
Cycle Mode:	TOC & Idle
Purge Print Interval:	Timed
Print Interval:	00:01:00 (hh:mm:ss)
% Change in Resistivity:	1 percent

All of these variables, default or user-entered, are stored in battery-backed memory within each Analyzer to avoid loss when the instrument is powered down. A **10–Bad Config** code is reported (see [“Alarm Codes” on page 165](#)) if a bad battery corrupts these values. In this instance, the default parameters must be restored and then modified as necessary.

Note:

This procedure restores all Analyzer parameters to their factory default values except customer calibrations, which are not affected.

To reset the instrument’s factory default parameters:

- 1) With the desired Analyzer selected in any View, press the **Setup Key**.

- 2) Use the **Up** and **Down Keys** to specify **Sensor Setup**.
- 3) Press **Enter** to display its submenu.
- 4) Specify **Analysis Setup** and press **Enter**.
- 5) Specify **More Setup**, press **Enter** to access its submenu and select **Sampl & Default**.
- 6) Use the **Up** and **Down Keys** to specify Factory Default.

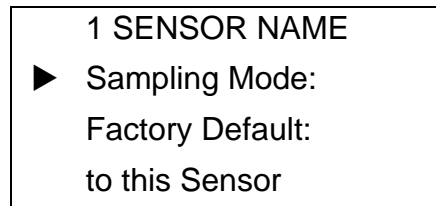

Fig 5-1 : Factory Default Selection

- 7) Press **Enter** to display the Factory Defaults Screen.
- 8) Press **Enter** once again to reinstate the Analyzer's default parameter settings; pressing **Esc** exits the screen without making any changes.

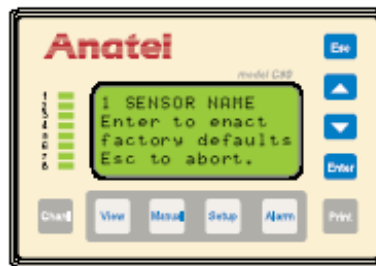

Fig 5-2 : Factory Defaults Screen

5.3 Password Security

Defaults: Identifier: Super
 Supervisor: 00000 (None)
 Identifier: Opera
 Operator: 00000 (None)

The TOC600 Analyzer's operational modes (Setup, Manual and Print) can be password protected to prevent unauthorized users from accessing any of the instrument's configuration or control parameters, as well as its printout functions. The TOC600 Analyzer allows two levels of password security:

- Supervisor who has access to all functions
- Operator who can alter everything but the password entries and the **Log Setup Menu** (see "[Internal Log](#)" on page 111) which contains the instrument's audit trail

The optional passwords are equipped with a required **Identifier** to trace accountability. Any parameter changes are recorded in the Analyzer's internal log for later retrieval and are automatically output to the printer (assuming one is attached). These records include the time,

the parameter and the date of the change in addition to identifying the person authorized to make the modification.

By default, no passwords are defined (indicated by settings of **00000**), thereby allowing complete access to all personnel. A password, once enabled, is constrained by a 90-day limit. In other words, active passwords must be changed every three months. An alarm code is issued three times a day—at 12:00 AM, 8:00 AM and 4:00 PM—when the assigned limit has expired. This code will continue to be displayed (and printed) until the Supervisor changes the current password settings. To further enhance this security feature, the same passwords cannot be used in two successive 90-day periods.

Note:

*Settings of **00000** for the Supervisor and the Operator disable this security feature.*

To establish a Supervisor Password and Identifier:

- 1) With the desired Analyzer selected in any View, press the **Setup Key** to display its submenu.
- 2) Use the **Up** and **Down Keys** to specify **Sensor Setup**.
- 3) Press **Enter** to access its submenu.
- 4) Specify **Display/Print** from among the available selections and press **Enter** to display its options.
- 5) Specify **Set Password** and press **Enter**.
- 6) Use the **Up** and **Down Keys** to specify **Supervisor ID** and press **Enter** to display that screen.



Fig 5-3 : Setting Supervisor Password Screen

- 7) Press **Enter** again and the flashing block cursor becomes a flashing underscore.

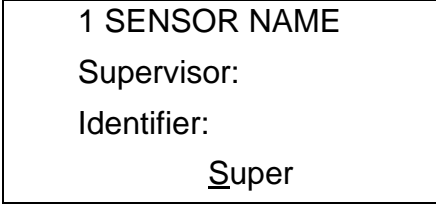

```
1 SENSOR NAME
Supervisor:
Identifier:
      Super
```

Fig 5-4 : Enter Supervisor ID

- 8) Use the **Up** and **Down Keys** to specify the initial character in the identification. An identification is five alphanumeric characters and case-sensitive.
- 9) Press **Enter** to advance to the next character and similarly select it.
- 10) Repeat the selection procedure to define the other characters.
- 11) With the desired **Identifier** displayed, press **Esc** to return to the **Set Password** screen.

Note:

Be sure to record the Identifier and Password somewhere in case it is forgotten.

- 12) Use the **Up** and **Down Keys** to select **Supervisor PW** and press **Enter** to display that screen.
- 13) Press **Enter** and the flashing block cursor again becomes a flashing underscore.

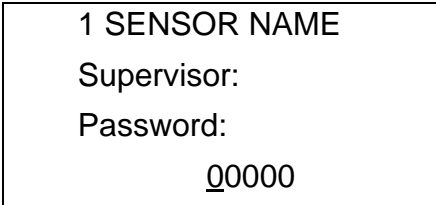

```
1 SENSOR NAME
Supervisor:
Password:
      00000
```

Fig 5-5 : Enter Supervisor Password

- 14) Similarly specify the Supervisor's password observing the same naming conventions as that used for the identification.
- 15) With the desired **Password** displayed, press **Esc** to enable this security feature and return to the **Set Password** screen.
- 16) If required, enter an **Operator Identifier** and **Password** using the same procedure.



Fig 5-6 : Setting Operator Password Screen

- 17) Press **Esc** to enable this security feature and return the instrument to normal operation. Once defined, a password must be entered in order to access the protected modes from a non-protected mode (**View**, **Channel** or **Alarm**). To disable the password, reset it to its default setting of **00000**.
 - 18) Press **Enter** and the flashing block cursor becomes a flashing underscore.
 - 19) Use the **Up** and **Down Keys** to select the initial character in the password.
 - 20) Press **Enter** to advance to the next character and similarly select it.
 - 21) Repeat the selection procedure to define the other password characters.
 - 22) With the correct password displayed, press **Esc** to continue with full instrument access.
- When changes to the TOC600 Analyzer have been completed, press **View** to exit this setting and safeguard access.

5.4 Display Units

Default: Conductivity

The **Display/Print** submenu determines which measurement units are logged, displayed and output to the printer. Sample conductivity is reported in microsiemens per centimeter ($\mu\text{S}/\text{cm}$) and resistivity is reported in megohm-centimeters ($\text{M}\Omega\text{-cm}$).

To specify the reported display units:

- 1) With the desired Analyzer selected in any View, press the **Setup Key** to display its submenu.
- 2) Use the **Up** and **Down Keys** to specify **Sensor Setup**.
- 3) Press **Enter** to access its submenu.

- 4) Specify **Display/Print** from among the available selections and press **Enter** to display its options.
- 5) Specify **Resis or Cond** and press **Enter**.

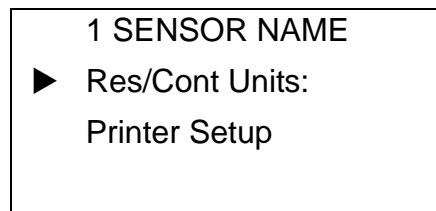

Fig 5-7 : Display Units Menu

- 6) Use the **Up** and **Down Keys** to select the desired format.

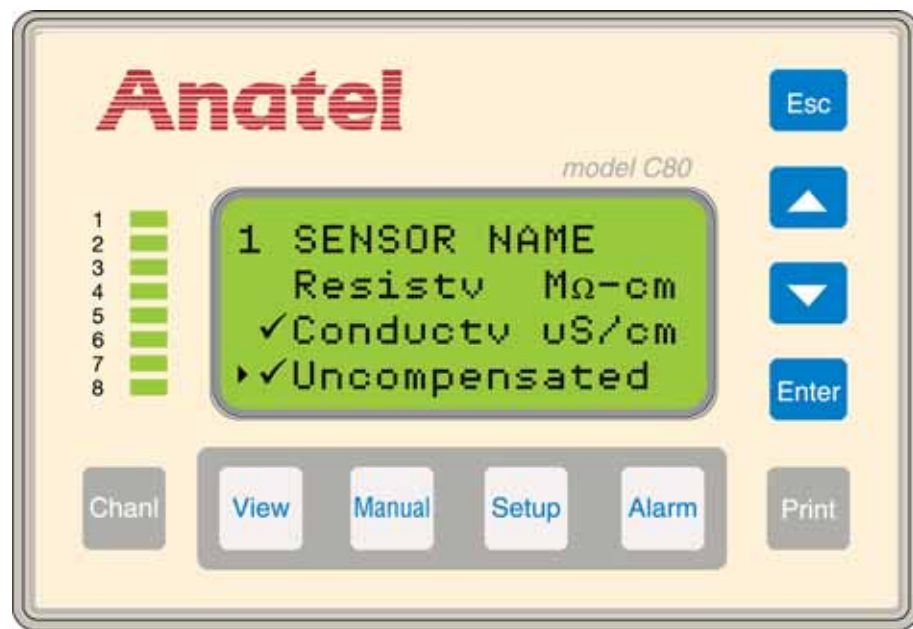

Fig 5-8 : Display Units Screen

The TOC600 Analyzer software can report the actual or temperature-compensated conductivity (or resistivity) of the sample water. Compensated values are displayed as if the solution was being measured at 25 °C: Compensated conductivities are displayed as **μ S C**. This calculation provides consistency from one analysis reading to the next regardless of changes in temperature.

However, compensation is not always desirable in pharmaceutical high-purity water applications, so the uncompensated mode uses the actual sample water conductivity in its report and alarm functions. Uncompensated conductivity is reported for the Analyzer in place of the temperature-compensated value on all the associated C80 Controller displays, as well as in all reports and any output signals. Any reported uncompensated values have units displayed as **μ S U** to distinguish them from compensated values.

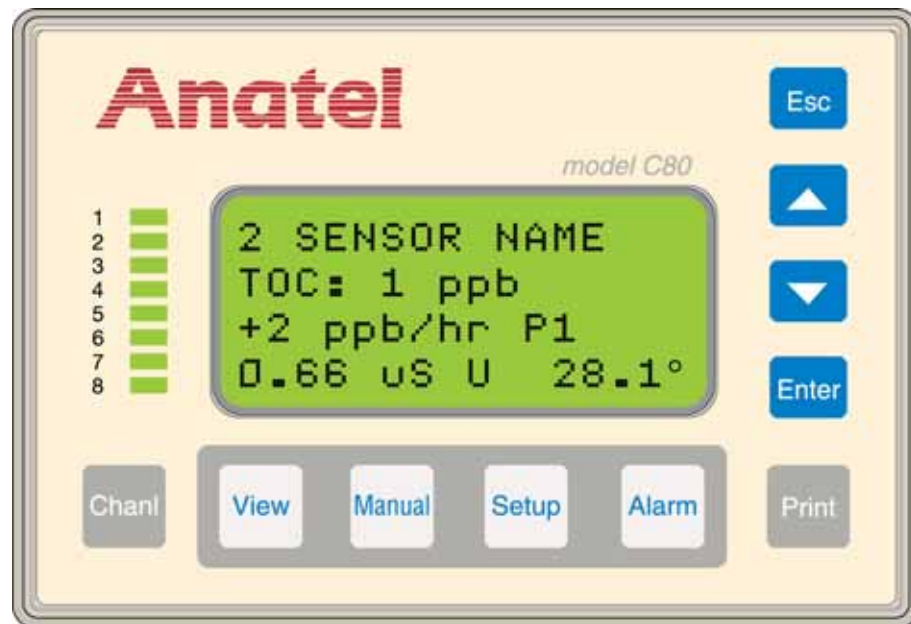

Fig 5-9 : Uncompensated Conductivity Display

Note:

The compared values are recorded at the beginning of the analysis and when the data are reported.

In addition to reporting the uncompensated values, values are monitored for limit excursions. The TOC600 Analyzer compares the uncompensated conductivity value to a set of USP (United States Pharmacopoeia) limits and issues an alarm if the corresponding limit is exceeded (see [“Uncompensated Conductivity Alarms” on page 102](#)).

The Uncompensated Mode is enabled or disabled independent of the individual instrument’s conductivity (or resistivity) display units.

Modifying an TOC600 Analyzer to report temperature-uncompensated conductivity or resistivity values requires altering its **Display Units Screen** to reflect this new output. If an external DAC module is being used, its range may have to be adjusted to account for the new output (see [“Conductivity/ Resistivity Output” on page 132](#)).

Note:

Uncompensated resistivity may be chosen, but this selection is for display only and does not generate an alarm as the USP limits are not checked in this case.

- 7) Use the **Down Key** to scroll to **Uncompensated** and press **Enter** to toggle the checkmark “on” and select the Uncompensated Mode. Choose **Conductv μ S/cm** in order to report uncompensated conductivity alarms (see [“TOC Validation” on page 84](#)).
- 8) Press **Esc** repeatedly to exit this function and return to the normal display.

A “C” designates a compensated and a “U” designates an uncompensated value in the Controller display. Thus, uncompensated conductivity is reported as “ μ S U” and “M. U” is displayed for an Analyzer reporting uncompensated resistivity.

The column headers on printed outputs similarly report “COND UNCMP” and “RESIS UNCMP,” respectively. In instances where the data for multiple instruments are combined into a single report or view, a separate unit is given for each line of data.

5.5 Auto TOC Mode

In this normal (default) operating mode, the TOC600 Analyzer conducts analysis and reporting functions based on its particular parameters. Water samples are analyzed independently by each instrument, their corresponding results displayed on the associated C80 Controller at the conclusion of each analysis cycle. Printouts are generated by an Analyzer’s attached printer as specified on its **Printer Setup Menu**. Automatic analysis and reporting continues until manually interrupted by the user or until a critical fault is encountered.

To select the Auto TOC Mode:

- 1) With the desired Analyzer selected in any View, press **Manual** to display its operational options.
- 2) Use the **Up** and **Down Keys** to specify Auto TOC.
- 3) Press **Enter** to enable the Auto TOC Mode.

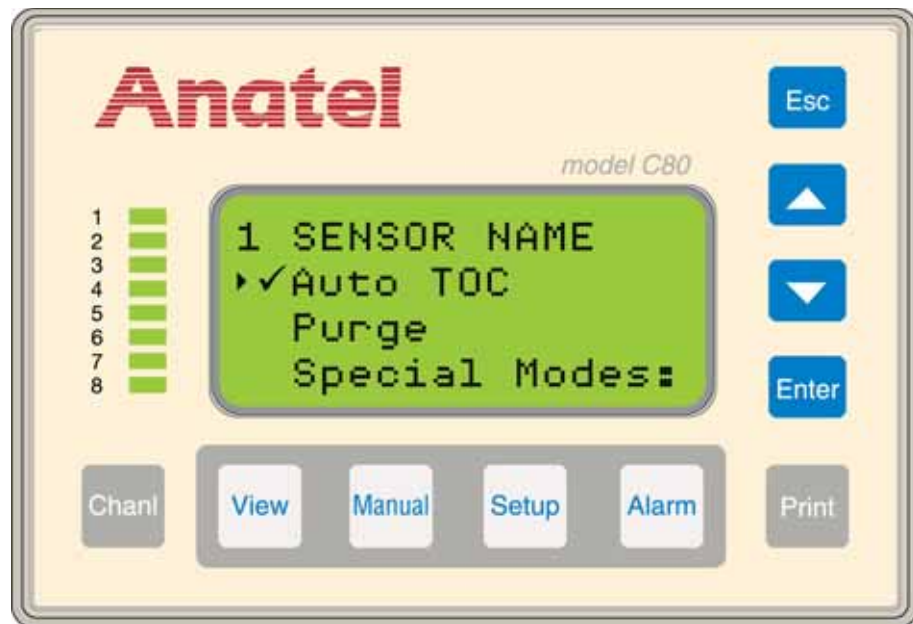

Fig 5-10 : Auto TOC Mode Selection

In this mode, water analyses are conducted automatically by the TOC600 Analyzer using a patented procedure. TOC measurement uses a microprocessor-controlled photocatalytic process in conjunction with conductivity detection. The initial conductivity of the water sample is determined to establish a reference value. An ultraviolet lamp then oxidizes the sample and the resulting change in conductivity is used to calculate the concentration of Total Organic Carbon present in parts per billion (ppb).

The Auto TOC analysis process is comprised of three successive stages:

- **Sample**
- **Oxidation**
- **Idle Times**

These intervals are referred to collectively as the Cycle Time, shown in [Figure 5-11](#). Cycle Time duration is specified in the Analyzer's setup (see "[Cycle Time](#)" on page 64).

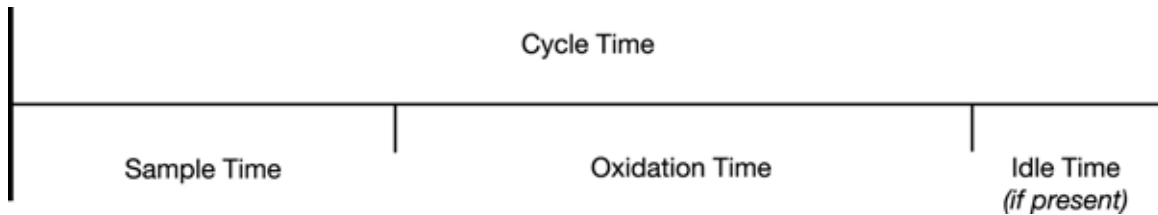
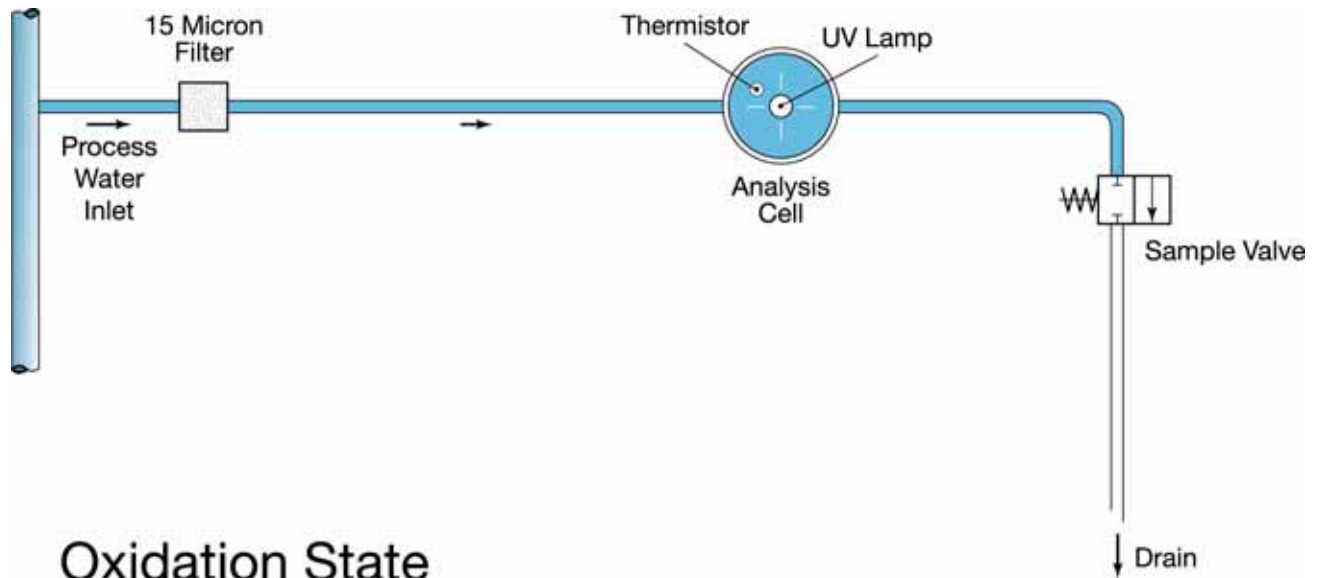

Fig 5-11 : Analysis Time Line

During the **Sample Time** interval, the UV lamp is turned off and the Analyzer's internal Sample Valve is opened to allow pressurized water from the Process Water Inlet to purge the measurement cell. The Sample Valve is closed at the conclusion of the **Sample Time** to capture a new sample in the cell. The conductivity and the temperature of the sample water are measured to establish reference values which are stored in the instrument's memory for use in calculating the TOC results.

During the Oxidation Time, the Analyzer's Sample Valve remains closed, the UV lamp is turned on and oxidation begins. This interval varies depending on the organic content of the water. The nature of the oxidation curve determines the sample to be one of the following Profile Types:

- Profile Type 1 ("P1") Easy to oxidize
- Profile Type 2 ("P2") Moderately difficult to oxidize (only in TOC levels below 50 ppb)
- Profile Type 3 ("P3") Difficult to oxidize (intermediate organic acids are formed)



Oxidation State

Note: Arrows indicate flow path

Fig 5-12 : Oxidation State

Conductivity is always increasing until oxidation is complete in a P1 sample. This indicates that few intermediate organic acids, which have higher conductivity than the equivalent CO_2 , are formed. A P3 sample contains significant amounts of these acids. Consequently, conductivity peaks then decreases as analysis nears completion. P2 samples occur at low TOC levels and are similar to a P1, or minor P3, sample in which the organic “background” of the measurement cell must be measured.

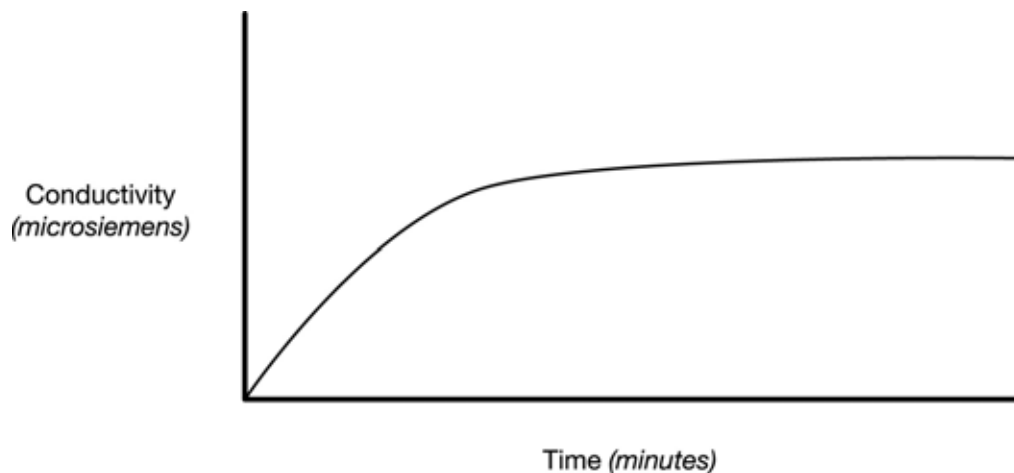

Fig 5-13 : P1-Type Oxidation Curve

Abrupt changes in the Profile Type can indicate a change in water chemistry. For example, a change from a P2 to a P3 Profile Type at a TOC level of 10 ppb, indicates a contamination shift towards more complex compounds. This comparison also is valid between water treatment systems when TOC levels are similar. Simple organics, such as methanol, report P1 up to moderate levels (in excess of 50 ppb). More complex organics tend to oxidize as a P3 Type at all but the lowest levels (less than 10 ppb). In this instance, complex indicates either very large organics with a high molecular weight or organics that contain some element which resists oxidation. As TOC levels vary, the location of this transition shifts but the accuracy of the measurement is maintained. Neither the Profile Type nor the analysis conditions cause any variations in TOC readings.

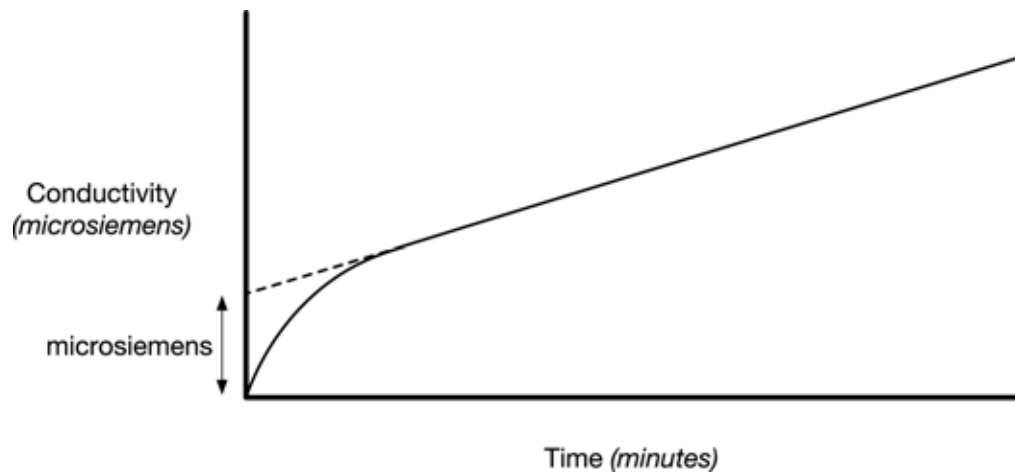

Fig 5-14 : P2-Type Oxidation Curve

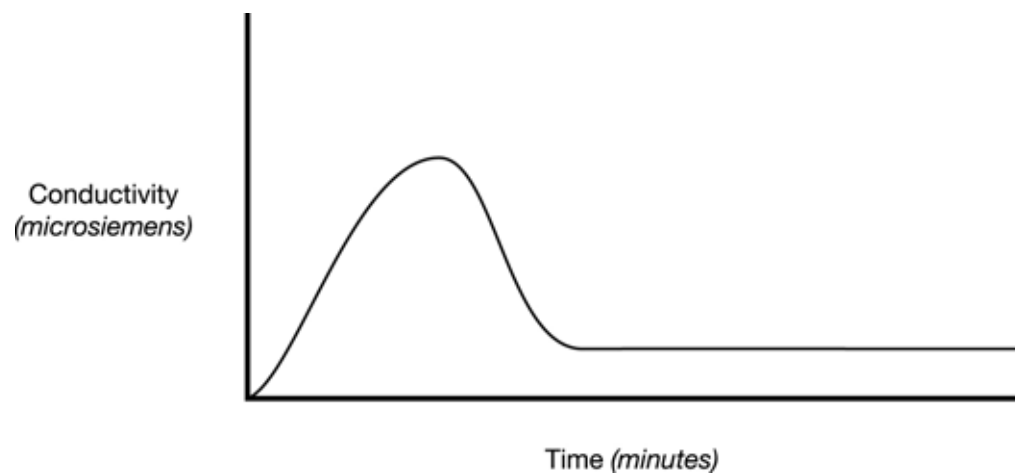

Fig 5-15 : P3-Type Oxidation Curve

The difference between the final equivalent TOC reading and the beginning reference value is calculated at the end of oxidation to yield the TOC content of the sample. The results of the

analysis are then reported on the instrument and the C80 Controller, as well as output to the printer.

If TOC analysis is complete before the set **Cycle Time** has elapsed, the instrument goes into an Idle State and awaits the start of the next analysis. During this **Idle Time**, the Sample Valve either allows or prevents sample water flow, depending on the Analyzer's **Sample Mode** setting (see "[Sampling Mode](#)" on page 65). When the setting is **Continuous**, the measurement cell is continuously purged until the conclusion of the **Cycle Time**; when **Water Saver** is selected, sample flow through the Analyzer is suspended until initialization of the subsequent **Sample Time**. If the **Cycle Time** is less than the duration of the analysis, the next analysis begins immediately. Thus, in order to perform continuous analyses, the Analyzer's **Cycle Time** should be set to the default of **0** minutes. This setting is recommended unless a fixed and lengthy (hourly) analysis is required.

5.5.1 Auto TOC Software Setup

There are several parameters which define TOC600 Analyzer operation in the Auto TOC Mode. These variables include setting the **Sample** and **Cycle Times**, as well as the instrument's Sample Mode setting. These time parameters are accessed through the instrument's **Times & Cycle Menu** and determine the duration of its analysis. As noted, the analysis **Cycle Time** is comprised of **Sample**, **Oxidation** and, in some instances, an **Idle Time**.

To access the TOC600 Analyzer's **Times & Cycle Menu**:

- 1) With the desired Analyzer selected in any View, press the **Setup Key** to display its submenu.
- 2) Use the **Up** and **Down Keys** to specify **Sensor Setup**.
- 3) Press **Enter** to access its submenu.
- 4) Specify **Analysis Setup** from among the available selections and press **Enter** to display its options.

The **Times & Cycle Menu** offers the following instrument-specific analysis parameters:

- **Sample Time** is the period of time water flows through the Analyzer before its internal sample valve closes and sample analysis begins.
- **Cycle Time** is the minimum length of time from the beginning of one analysis to the beginning of the subsequent analysis.
- **Cycle Modes** allows conductivity (or resistivity) and temperature readings to be reported while the instrument is purging between analyses.

Sample Time

Default: 1 Minute

The **Sample Time** is the period during which water flows through the TOC600 Analyzer's measurement cell prior to oxidation. This ensures that a discrete and representative water sample is oxidized during each analysis. The interval is user-selectable from **00:00:00** to **17:59:59** and a proper setting helps assure accurate and timely analysis results.

During the **Sample Time**, the Sample Valve is open to allow the measurement cell to purge of any residual contamination. An empirical method for determining an appropriate **Sample Time** for any flow rate is to switch the instrument into the Purge Mode at the end of an oxidation cycle and note the time it takes for the resistivity reading to stabilize. Double this time to obtain a

proper **Sample Time** interval. For systems where the water pressure varies, use the average of several such readings or update the Sample Time settings when inlet conditions change.

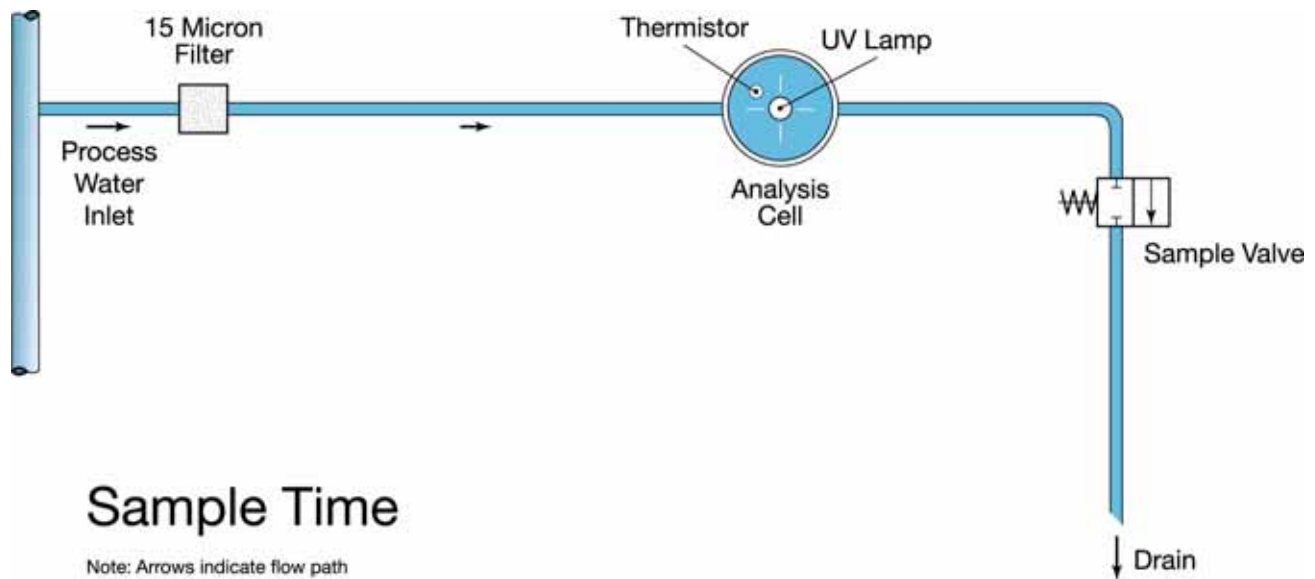

Fig 5-16 : Sample Time

The Analyzer must be rinsed completely in order to accurately measure sample resistivity. Even minute amounts of residual oxidation products will increase the conductivity of a high-purity water sample considerably. The TOC600 Analyzer compensates the reported conductivity for variations in temperature caused by using high intensity UV which, in conjunction with an integral heater, warms the measurement cell. A substantial **Sample Time** reestablishes the temperature balance as well as flushing the previous sample.

As an example, in 0.05 $\mu\text{S}/\text{cm}$ water containing 100 ppb TOC, a rinse of 99% will lower the measured TOC by only 1 ppb. Sample conductivity, however, will degrade by more than 0.4 $\mu\text{S}/\text{cm}$.

For analyses from sources where the water pressure exceeds 15 psig, a good rule-of-thumb is to set the **Sample Time** to two minutes. The setting should be increased by one additional minute for each two meters of 1/4" sample tubing, and another minute for each 10 °C differential in temperature between the sample water and the room temperature.

Although a lengthy **Sample Time** guarantees the most accurate conductivity and temperature readings, adequate TOC sampling can be accomplished in shorter intervals. In cases where the Sample Time must be limited, the setting should allow a 60 mL sample flow through the instrument with an additional 25 mL for each meter of 1/4" tubing traveled. Measure the flow through the instrument during the preoxidation **Sample Time** and calculate the time necessary for this volume of water. The flow rate can be checked and verified with a stopwatch or second hand and a beaker or graduated cylinder.

To set the instrument's **Sample Time**:

- 1) With the **Times & Cycle Menu** displayed, use the **Up** and **Down Keys** to specify **Sample Time**.

- 2) Press **Enter** to access its parameter screen. The current **Sample Time** is displayed in an hour:minute:second format and represents duration, not clock time. The flashing block cursor highlights the hour division.

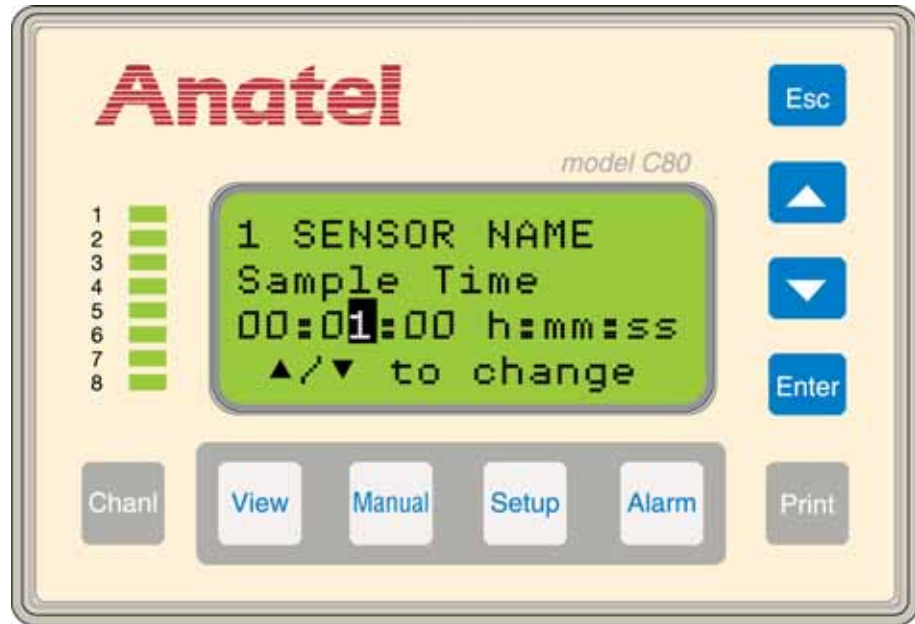

Fig 5-17 : Sample Time Screen

- 3) Use the **Up** and **Down Keys** to specify the time division to be changed.

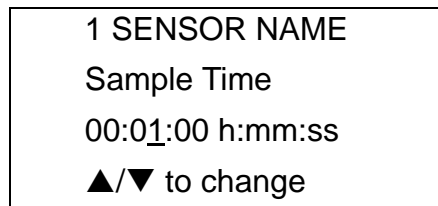

Fig 5-18 : Sample Time Displayed

- 4) Press **Enter** to enable the Controller's Edit Mode and the flashing block becomes an underscore.
- 5) Use the **Up** and **Down Keys** to scroll until the desired period is displayed. A minimum **Sample Time** of one minute is recommended for the best TOC analysis results.

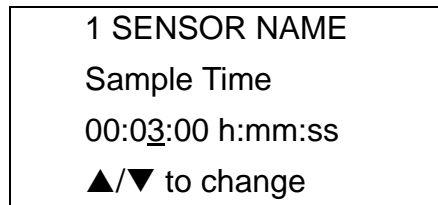

Fig 5-19 : Change Sample Time

- 6) Press **Enter** to update the setting and advance to the next time segment.
- 7) Repeat the editing process with each time division until the desired **Sample Time** has been entered into the display.
- 8) Press **Esc** twice to retain the setting and return to the **Times & Cycle Menu**.

Cycle Time

Default: 0 minutes

The **Cycle Time** is user-selectable from **00:00:00** to **99:59:59** (100 hours) and defines the minimum duration of the analysis. If the **Cycle Time** exceeds the period required for the combined sample and oxidation steps, the TOC600 Analyzer defaults to an Idle state until the next analysis is scheduled to begin. If the specified **Cycle Time** is less than the combined sample and oxidation times, the next analysis begins immediately.

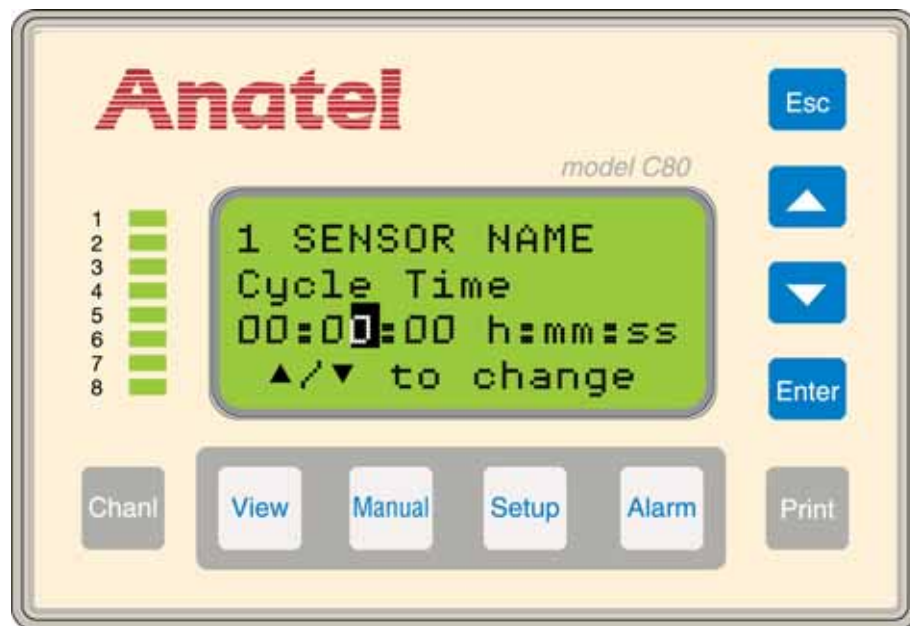

Fig 5-20 : Cycle Time Screen

To set the instrument's **Cycle Time**:

- 1) With the **Times & Cycle Menu** displayed, use the **Up** and **Down Keys** to specify **Cycle Time**.
- 2) Press **Enter** to access its parameter screen. The current **Cycle Time** is displayed in an hour:minute:second format, the flashing block cursor highlighting the hour division.
- 3) Use the **Up** and **Down Keys** to specify the time division to be changed.
- 4) Press **Enter** to enable the Controller's Edit Mode and the flashing block becomes an underscore.

```

1 SENSOR NAME
Cycle Time
00:00:00 hh:mm:ss
▲/▼ to change

```

Fig 5-21 : Cycle Time Displayed

- 5) Again use the **Up** and **Down Keys** to scroll until the desired period is displayed. For example, if the **Cycle Time** is set to **00:30:00**, TOC data will be available at 30-minute intervals. Be sure that the frequency of data reports is appropriate for process management requirements when determining this interval.

```

1 SENSOR NAME
Cycle Time
00:30:00 hh:mm:ss
▲/▼ to change

```

Fig 5-22 : Change Cycle Time

Note:

*For continuous analyses, set the **Cycle Time** to 0.*

- 6) Press **Enter** to retain the setting.
- 7) Repeat the editing process with each time division until the desired **Cycle Time** has been entered into the display.
- 8) Press **Esc** repeatedly to exit this function and return to the normal display.

Sampling Mode

Default: Water Saver

The **Sampling Mode** setting determines the state of the Analyzer's internal valve during the **Idle Time** interval (if any) that occurs between the completion of a TOC analysis and the initiation of the next analysis (based on the set **Cycle Time**). Sample flow through the instrument can be minimized during idle time to conserve water or the system can be flushed continuously to prevent dead leg conditions.

To specify the **Sampling Mode**:

- 1) With the desired Analyzer selected in any View, press the **Setup Key** to display its submenu.
- 2) Use the **Up** and **Down Keys** to specify **Sensor Setup**.
- 3) Press **Enter** to access its submenu.
- 4) Specify **Analysis Setup** and press **Enter**.
- 5) Specify **More Setup** and press **Enter**.
- 6) Specify **Sampl & Defalt** from among the available selections and press **Enter** to display its options.

- 7) Specify **Sampling Mode** and press **Enter** to display its parameter screen.

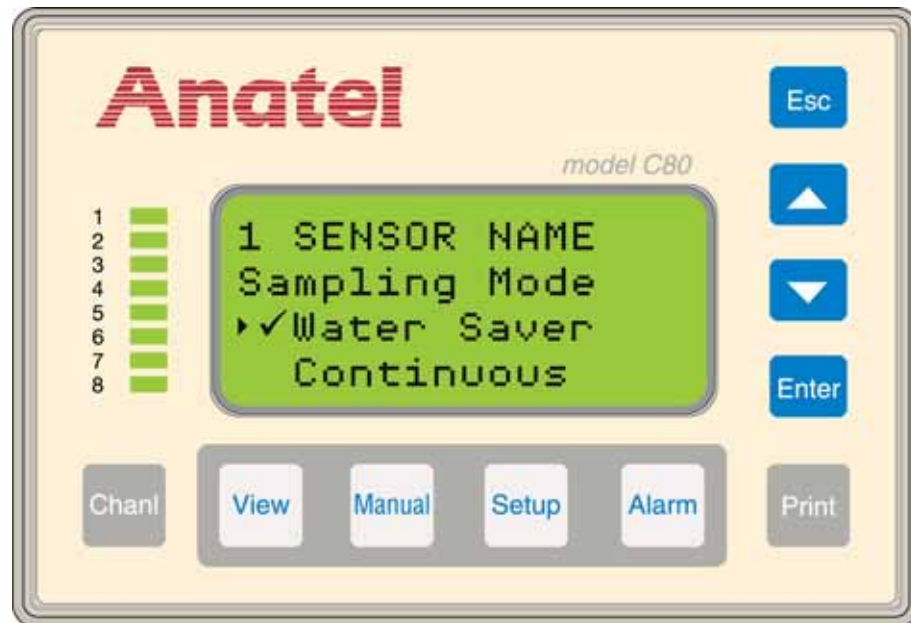

Fig 5-23 : Sampling Mode Screen

- 8) Use the **Up** and **Down Keys** to choose the desired sample valve setting:
- **Water Saver** stops sample water flow through the analysis portion of the instrument.
 - **Continuous** constantly purges the instrument's flow path between oxidation cycles.
- 9) With the desired **Sampling Mode** setting indicated, press **Enter** to enable it.
- 10) Press **Esc** repeatedly to exit this function and return to the normal display.

Cycle Modes

Default: TOC & Idle

The TOC600 Analyzer can report the conductivity (or resistivity) and temperature of the sample water during the instrument's **Idle Time** (see "[Cycle Time](#)" on page 64), if desired, through the Cycle Modes. For example, a one-hour **Cycle Time** may require 15 minutes for TOC analysis; the instrument purges for the remaining 45 minutes until the next analysis cycle is initiated. Conductivity (or resistivity) values may be displayed and printed during this interval. The default is not to report these readings so that the last TOC analysis data is displayed at all times.

To enable **Cycle Modes** data reporting:

- 1) With the desired instrument selected in any View, press the **Setup Key**.
- 2) Use the **Up** and **Down Keys** to specify **Sensor Setup** and press **Enter**.
- 3) Select **Analysis Setup** and press **Enter**.
- 4) Select **Times & Cycle** and press **Enter**.

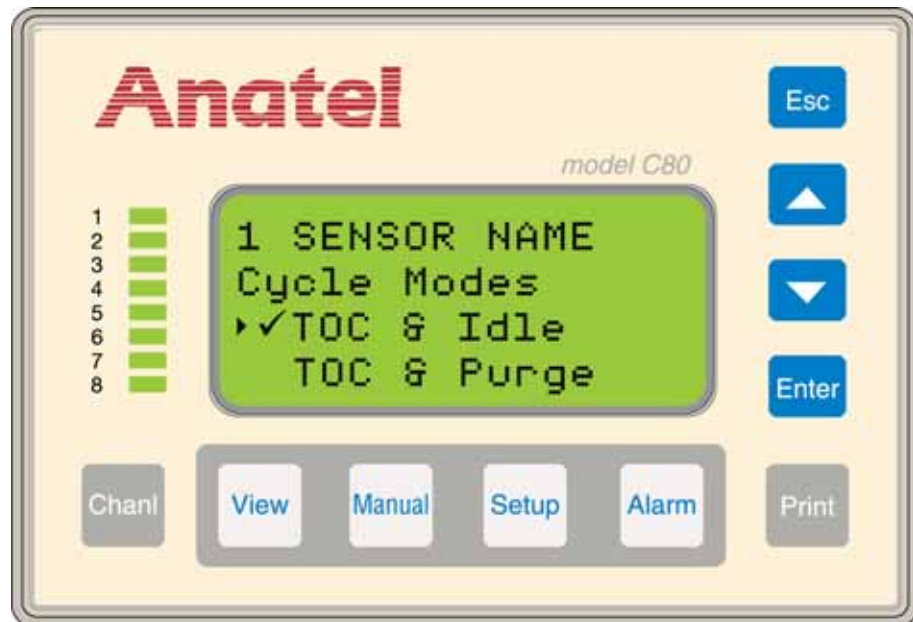

Fig 5-24 : Cycle Modes Screen

- 5) Select **Cycle Modes** and use the **Up** and **Down Keys** to choose the desired setting:
 - **TOC & Idle** displays the data from the last TOC analysis during the **Cycle Time** Idle interval.
 - **TOC & Purge** displays conductivity (or resistivity) and temperature data during the instrument's **Idle Time**.
- 6) With the desired **Cycle Mode** setting indicated, press **Enter** to enable it.
- 7) Press **Esc** repeatedly to exit this function and return to the normal display.

Reporting of this **Cycle Time** data can be limited to display only by disabling purge printouts (see [“Purge Mode Printouts”](#) on page 71). TOC results will continue to be printed as specified in [“Auto TOC Mode Printout”](#) on page 68.

5.5.2 Auto TOC Mode Printout

Default: Continuous

TOC600 S/N XXXXX ID: 1 Name: SENSOR NAME						
TOC LIMIT [PPB] 500	SAMPLE TIME [hh:mm:ss] 00:01:00	CYCLE TIME [hh:mm:ss] 00:00:00				

07/31/2007						
TIME	TOC [PPB/HR]	%AL	TREND [PPB/HR]	RESIS UNCMP	TEMP °C	CRV TYP
16:14	137	27%	0	0.08	31.5	P3
16:17	137	27%	0	0.08	31.5	P3
16:20	139	28%	0	0.06	31.3	P3
16:23	139	28%	0	0.06	31.2	P3
16:26	138	28%	0	0.08	31.2	P3
16:29	139	28%	0	0.06	31.0	P3
16:32	138	28%	0	0.07	31.1	P3
16:35	136	27%	0	0.06	31.0	P3
16:38	137	27%	0	0.07	31.0	P3
16:41	138	28%	0	0.06	31.2	P3
16:44	140	28%	0	0.08	31.0	P3

Fig 5-25 : Sample TOC Printout

The TOC printout furnishes the TOC600 Analyzer Analyzer information listed in [Figure 5-2](#).

Table 5-2 : TOC Printout Information

Sensor	The Model Number of the instrument.
SN	The Serial Number of the instrument.
ID	Its Channel ID Number.
Name	The user-entered name of the instrument.
TOC LIMIT	The instrument's set TOC alarm limit.

Table 5-2 : TOC Printout Information

SAMPLE TIME	The instrument's set Sample Time .
CYCLE TIME	The instrument's set Cycle Time .
Data	
	The Current Date .
TIME	The time when the sample was captured.
TOC [PPB]	The measured TOC of the sample in parts per billion.
%AL	The current TOC value as a percentage of its set Alarm Limit .
TREND [PPB/HR]	The TOC directional trend in ppb over the last hour.
COND (or RESIS)	The conductivity (or resistivity) of the sample if it is temperature-uncompensated.
TEMP	The temperature of the sample.
CRV TYP	The profile type of the sample.

Two **TOC Print** intervals are available. **Continuous** generates a TOC printout at the conclusion of each analysis; **Paper Saver** triggers a printout only when the change in TOC level between analyses exceeds a user-defined percentage.

To set the instrument's **TOC Print** interval:

- 1) With the desired Analyzer selected in any View, press the **Setup Key** to display its submenu.
- 2) Use the **Up** and **Down Keys** to specify **Sensor Setup**.
- 3) Press **Enter** to access its submenu.
- 4) Specify **Display/Print** and press **Enter**.
- 5) Select **Printer Setup** from the **Display/Print** menu and press **Enter**.
- 6) Specify **TOC Print** and press **Enter**.

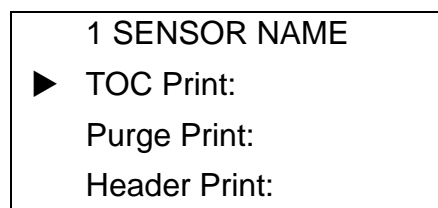

Fig 5-26 : TOC Print

- 7) Use the **Up** and **Down Keys** to specify one of the two **TOC Print** outputs.

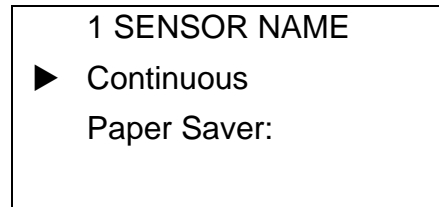

Fig 5-27 : TOC Print Format

- 8) Press **Enter** to select the specified format.
- **Continuous** generates a printout at the conclusion of each analysis.
 - **Paper Saver** generates a printout only when the difference in TOC values between the current and the previous analysis exceeds a user-specified percentage. If this format is chosen, the **% Change in TOC** must be specified. A flashing cursor underscores the setting.

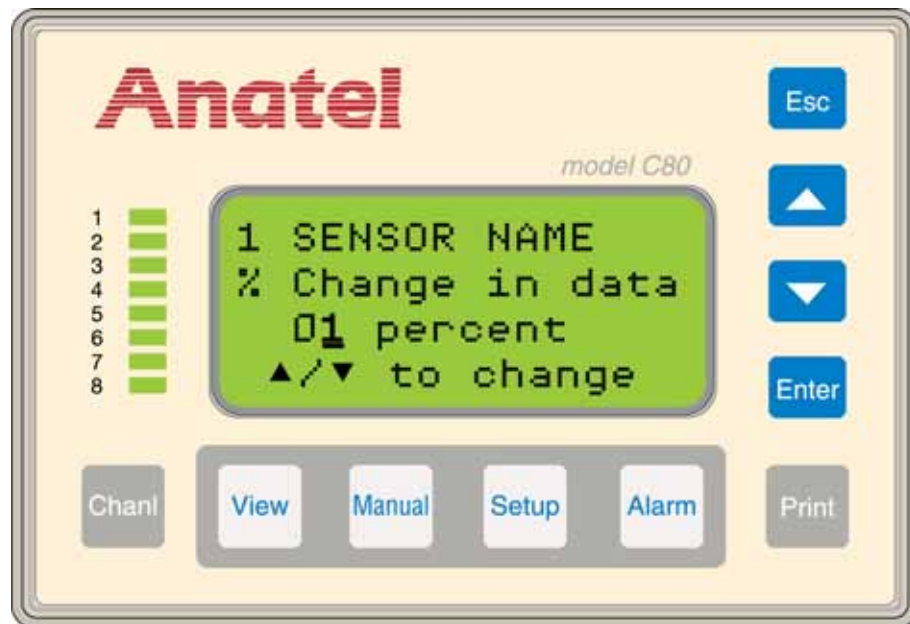

Fig 5-28 : Paper Saver Print Screen

- 9) Use the **Up** and **Down Keys** to scroll the value until the desired percentage is displayed.
- 10) Press **Esc** repeatedly to exit this function and return to the normal display.

5.6 Purge Mode

In the Purge Mode, the TOC600 Analyzer's internal sample valve is open to permit sample water to continuously flow through its measurement cell. This action provides a method of

reporting the conductivity (or resistivity) and temperature values on the Controller's display and on local printouts.

To place the Analyzer in the Purge Mode:

- 1) With the desired instrument selected in any View, press the **Menu Key** to display its options.
- 2) Use the **Up** and **Down Keys** to specify **Modes** and press **Enter**.
- 3) Select **Purge** from the available selections and press **Enter** to enable the Purge Mode. The Analyzer remains in this operational state until another Mode is chosen.

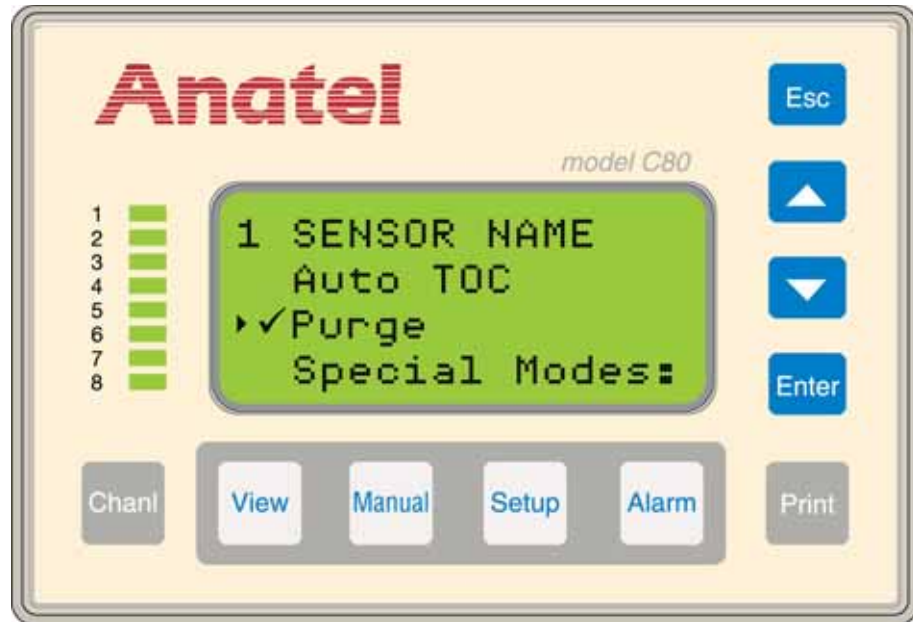

Fig 5-29 : Selecting the Purge Mode

5.6.1 Purge Mode Printouts

Default: Timed / 1 Minute

As with the Auto TOC Mode, there are three Purge Mode Print intervals:

- Timed generates a purge printout at user-specified intervals.
- Paper Saver triggers a purge printout only when the change in the water sample's conductivity (or resistivity) level exceeds a user-defined percentage in two successive analyses.
- Disabled inhibits all printouts.

The Purge Printout reports the value shown in [Table 5-3](#).

Table 5-3 : Purge Printout Reports

Sensor	Model Number of the instrument.
SN	Serial Number of the instrument.
ID	Instrument Channel ID Number
Name	User-entered name of the instrument.
Data	Current date
TIME	Time at which the measurement was taken.
COND UNCMP	Conductivity of the sample and whether it is temperature-uncompensated.
TEMP °C	Temperature of the sample in °C.

Note:

Conductivity is shown as "COND uS/cm" if it is temperature compensated.

TOC600 Analyzer S/N xxxxx ID: 2 Name: SENSOR NAME		

07/31/2006		
TIME	COND UNCMP	TEMP [C]
12:07	0.66	28.0
12:08	1.25	27.5
12:09	1.27	27.3
12:10	1.25	27.3
12:11	1.26	27.3
12:12	1.25	27.3
12:13	1.25	27.2
12:14	1.22	27.3
12:15	1.23	27.3
12:16	1.25	27.3

Fig 5-30 : Purge Printout

To specify a **Purge Print** interval:

- 1) With the desired instrument selected in any View, press the **Setup Key** to display its submenu.
- 2) Use the **Up** and **Down Keys** to specify **Sensor Setup**.

- 3) Press **Enter** to access its submenu.
- 4) Specify **Display/Print** from among the available selections and press **Enter** to display its options.
- 5) Select **Printer Setup** and press **Enter**.
- 6) Specify **Purge Print** and press **Enter**.
- 7) Use the **Up** and **Down Keys** to specify one of the two **Purge Print** outputs:
 - **Timed** generates a printout at the specified interval (*Default: 1 Minute*).
 - **Paper Saver** generates a printout when the difference in conductivity values between the current and the previous analysis cycle exceeds a specified percentage. If chosen, this **% Change** in data must be specified (*Default: 1 percent*).
 - **Disabled** inhibits all printouts. This option can be used in conjunction with the Cycle Mode **TOC & Purge** setting (see [“Purge Mode Printouts” on page 71](#)) to limit printouts to TOC data (*Default: Off*).

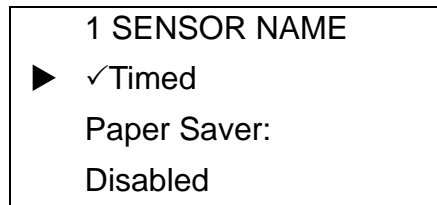

Fig 5-31 : Purge Print Outputs

- 8) Press **Enter** to select the specified format. A flashing cursor highlights the current value.

Timed Purge Print

If **Timed Purge Print** is selected, a flashing block cursor highlights the minutes division.

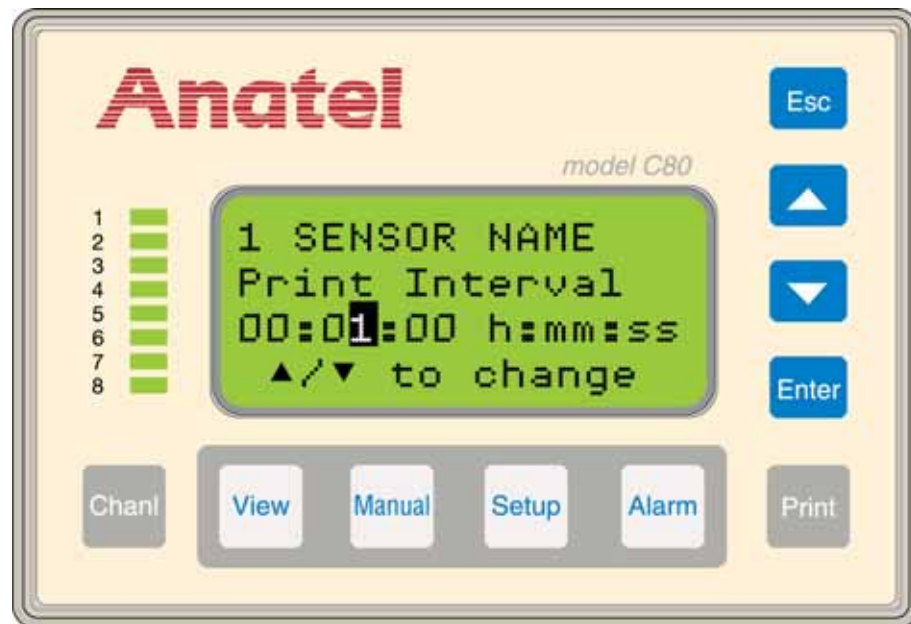

Fig 5-32 : Timed Purge Print Screen

- 1) Use the **Up** and **Down Keys** to specify the time division to be changed.
- 2) Press **Enter** to enable the Controller's Edit Mode and the flashing block becomes an underscore.
- 3) Use the **Up** and **Down Keys** to scroll until the desired period is displayed.

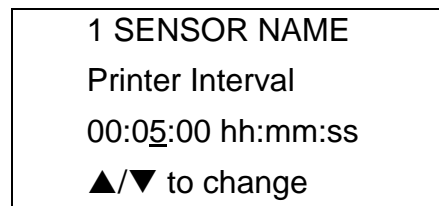

Fig 5-33 : Timed Purge Print

- 4) Press **Enter** to save the setting.
- 5) Repeat the editing process with each time division until the entire **Print Interval** has been entered into the display.
- 6) Press **Esc** repeatedly to exit this function and return to the normal display.

Paper Saver Purge Print

If **Paper Saver Purge Print** is selected, a flashing cursor underscores the second digit of the setting.

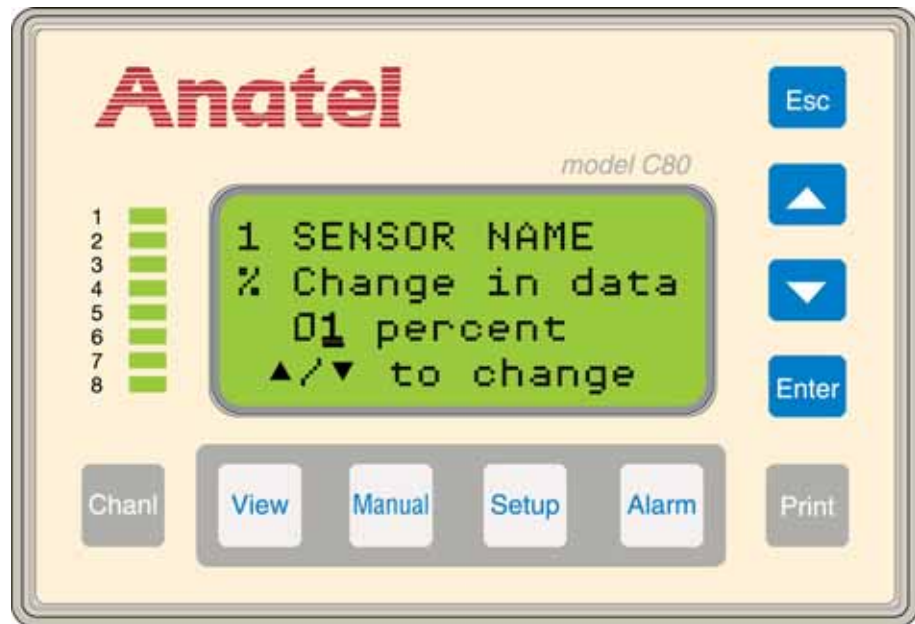

Fig 5-34 : Paper Saver Print Screen

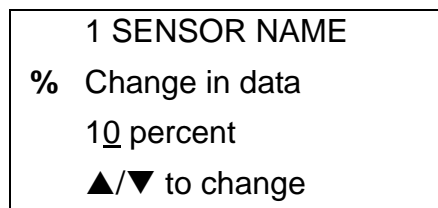

Fig 5-35 : Paper Saver Print

- 1) Use the **Up** and **Down Keys** to scroll the value until the desired percentage is displayed.
- 2) Press **Esc** repeatedly to exit this function and return to the normal display.

5.7 Header Print

Default: Default

Two **Header Print** options are available:

- **Default:** prints header information on "Power On," "Mode Changes," and daily at 12:00 AM
- **Every Sample:** prints header information for online sample modes "Sample" and "Manual" after each TOC analysis

To set the instrument's **Header Print** option:

- 1) With the desired Analyzer selected in any View, press the **Setup Key** to display its submenu.
- 2) Use the **Up** and **Down Keys** to specify **Sensor Setup**.

- 3) Press **Enter** to access it submenu.
- 4) Specify **Display/Print** and press **Enter**.
- 5) Select **Printer Setup** from the **Display/Print** menu and press **Enter**.
- 6) Specify **Header Print** and press **Enter**.

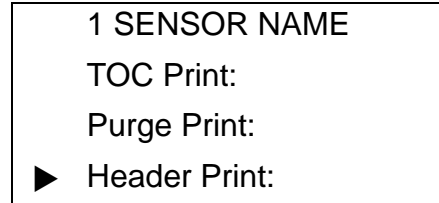

Fig 5-36 : Header Print

- 7) Use the **Up** and **Down Keys** to specify one of the two **Header Print** options.

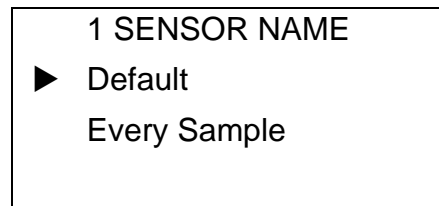

Fig 5-37 : TOC Print Format

- 8) Press **Enter** to select an option.
- 9) Press **Esc** repeatedly to exit this function and return to the normal display.

5.8 Manual Mode

Analysis and reporting functions are continuous when the TOC600 Analyzer is in the Auto TOC Mode. There are times, however, when manual control over the instrument's analysis is desirable. The **Manual Samples** menu selection allows the user to conduct a single sample analysis when necessary.

The Manual Mode is used to interrupt the current analysis in order to start a new analysis. It is convenient for initiating a manual analysis during TOC600 Analyzer installation, or to synchronize analysis with process equipment (sampling is under user control).

Access to the Analyzer by other connected C80 Controllers is denied while the instrument is in the Manual Sample or Oxidation State. Access is restored when the Manual Mode is exited.

5.9 Online Samples

The TOC600 Analyzer can perform individual analyses of online samples, with sampling controlled by the user.

To conduct an online sample measurement:

- 1) With the desired Analyzer selected in any View, press the **Manual Key** to access its menu selections.
- 2) Use the **Up** and **Down Keys** to specify **Manual Samples**.

- 3) Press **Enter** to display its submenu.
- 4) Use the **Up** and **Down Keys** to specify **Online Samples** and press **Enter** to display its submenu.
- 5) Use the **Up** and **Down Keys** to specify **Sampl.**

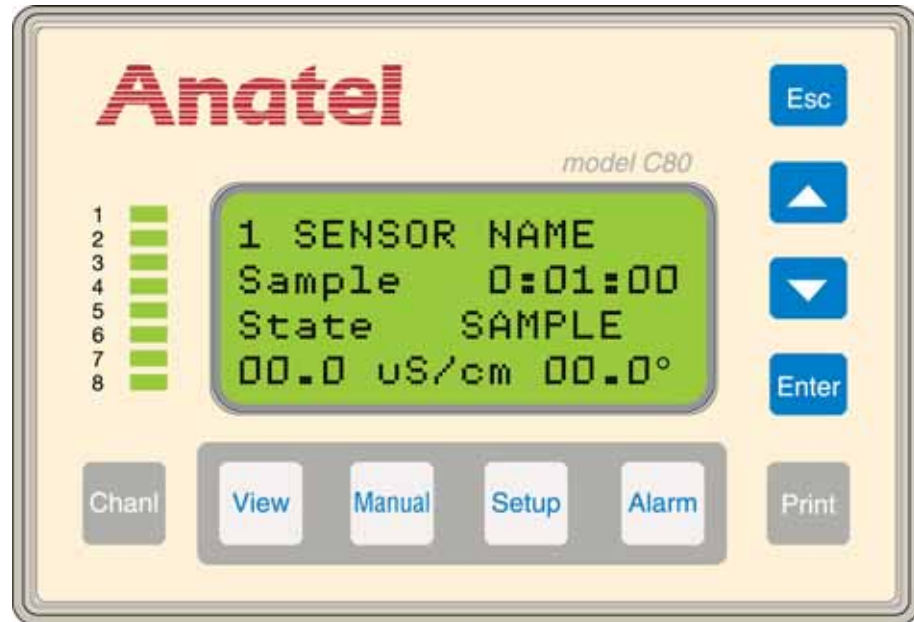

Fig 5-38 : Manual Sample State

- 6) Press **Enter** to initiate a single analysis. **Sampl** reflects the **Sample Time** interval specified in the Analyzer's setup (see "[Sample Time](#)" on page 61). Note this if the sample interval is to be matched. The instrument's analysis **State** and values are reported as soon as they become available.

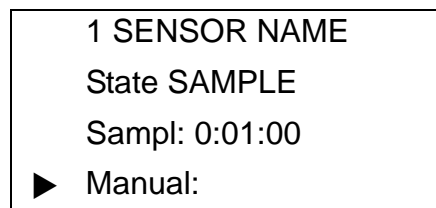

Fig 5-39 : Sample Time Interval

- 7) Press **Esc** to return to the **Online Samples Menu**.
- 8) Use the **Up** and **Down Keys** to specify **Manual**.
- 9) Press **Enter** to access its parameters and initiate a single analysis. The **Duration** of the sampling period is reported during the course of the fill.
- 10) Press **Enter** to stop sampling and the analysis continues with the Oxidation (measurement) stage. Once oxidation is complete, the sample's TOC value is displayed.

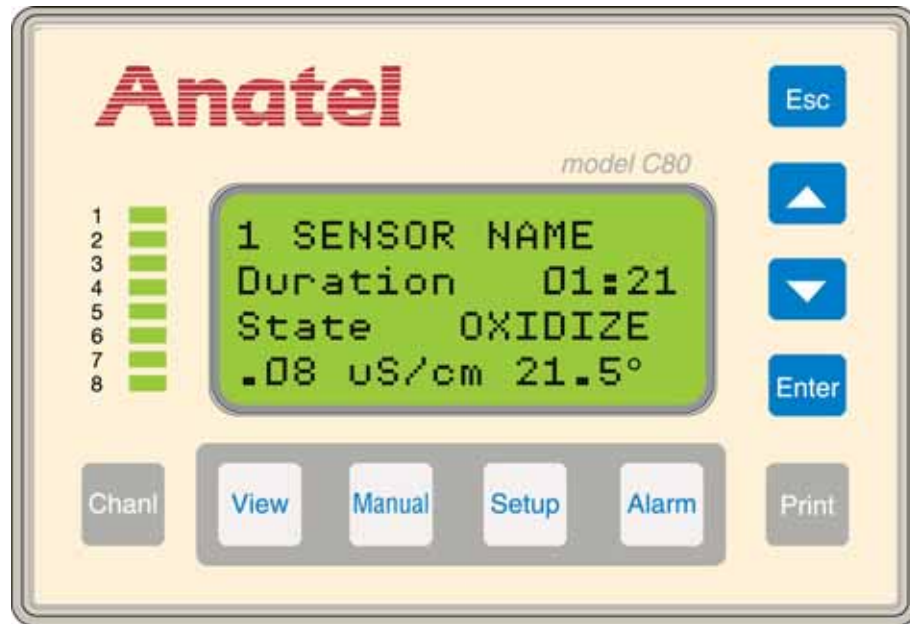

Fig 5-40 : Manual Oxidize State

The Manual Mode can be terminated at any time by pressing the **Esc Key** to exit the screen.

6 Calibration and Validation

6.1 General Information

TOC600 Analyzer calibration, system suitability, and validation are performed using the optional CSV Module, P/N FG1200650. This portable unit can be connected directly to the inlet and outlet fluid connectors of the analyzer. The CSV Module may also connect to the optional bypass three-way valves installed in the inlet and outlet water supply lines as described in [“Bypass Valve Installation” on page 24](#).

Calibration assures the accuracy of instrument’s readings at regular intervals; validation ensures the accuracy of the calibration by “challenging” it with the analysis of a known standard. Calibration and validation data are available for viewing via a C80 Controller or through a local or network printer.

Note:

The TOC600 Analyzer is calibrated at the factory before shipment. It is not necessary to perform a TOC Calibration prior to placing the instrument into service.

Proper calibration of the TOC600 Analyzer is critical to maintaining optimum instrument performance. There are several approaches to calibration to run unknown samples and accurately report the results. Calibration and validation involve running analyses of one or more standards and blanks in order to determine instrumental response:

TOC Calibration	Select from up to three levels (250, 500 and 750 ppb) of a sucrose standard. The procedure also allows up to three analysis replicates per standard for maximum accuracy.
TOC Validation	Perform either a single-point or multipoint validation of the TOC calibration using up to three levels of sucrose validation standards.
Conductivity Calibration	Performed according to the guidelines established in USP Method <645>. The procedure uses a NIST-traceable 100 μ S/cm conductivity standard for cell constant verification.
System Suitability	Performed according to the guidelines established in USP Method <643> using prepackaged 500 ppb sucrose and 500 ppb 1,4-benzoquinone standards.

Each procedure is prompted by a series of menus and all analyses are performed automatically. The necessary materials are available from Hach Ultra in prepackaged standards kits.

Note:

These are intended as general instructions on the performance of the calibration and validation procedures. Refer to the specific Standard Operating Procedure (SOP) for detailed instructions.

6.2 TOC Calibration

Calibration assures the accuracy of the TOC values obtained by the TOC600 Analyzer. TOC values are determined by measuring the change in conductivity of a high-purity water sample as its organic compounds are oxidized to carbon dioxide inside the instrument's analysis cell. The confirmation procedure subtracts the average of a series of background TOC measurements from the average of a series of working standard measurements.

Note:

Refer to Standard Operating Procedure (SOP) #TOC600–1A for complete instructions on performing this procedure.

The Anatel TOC600 Analyzer was designed to be calibrated by the user. Hach Ultra provides prepackaged standards to assist the user in simplifying the calibration process and to easily comply with USP TOC Method <643>. If desired, standards can be prepared by the user for use with the TOC600 Analyzer. User-prepared standards will not affect or alter the calibration of the instrument. User-prepared standards must be introduced into the Analyzer using the CSV module to ensure proper coordination with the C80 instructions. At least 125 ml is required of each standard solution. The required container/closure system includes a 125 mL HDPE bottle and a Teflon[®]-coated septa seal cap.

Note:

The user is responsible for the traceability and USP compliance of all standards that are not pre-packaged.

Linear regression is performed on the data and a correlation coefficient (R) for the analysis is reported. The instrument automatically determines whether the calibration passes or fails based on the factory calibration. If the absolute value of the percent slope change (%_{SC}) of the new calibration is ≤15% of the factory calibration, the instrument indicates that the new calibration has passed. If the result is >15% of the factory calibration, the Analyzer indicates that the new calibration has failed.

Note:

The correlation coefficient, a user-accepted (R) value, should be ≥0.990. The calibration will not fail if the R value is ≤0.990, only if the % slope change is not within the specified limits.

To perform a TOC calibration:

- 1) With the desired Analyzer selected in any View, press the **Manual Key** to access its menu selections.
- 2) Use the **Up** and **Down Keys** to specify **Calibrations**.
- 3) Press **Enter** to display its submenu.
- 4) Use the **Up** and **Down Keys** to specify **Calibrate**.
- 5) Select **TOC Calibrate** and press **Enter**. If the Analyzer is connected to an Anet network on which other instruments reside, confirm that it is the correct instrument by verifying its serial number.



WARNING

Some instrument surfaces may be hot if the sample water is hot. Allow surfaces to cool before touching.

CAUTION:

In a networked environment (see “Network Installation” on page 35), it is important to confirm the instrument’s Serial Number before proceeding. Operation of the wrong Analyzer could result in water leakage when the inlet and outlet sample lines are removed during this procedure. The inlet and outlet sample lines are removed.

The Analyzer will begin a temperature stabilization process, its duration depending on the sample water temperature. The actual time required is displayed and counted down.

- 6) Press **Enter** to continue.
- 7) Connect the CSV Module by attaching the CSV Module to the analyzer.
 - Connect the fluid tubing from the standards bottle to the analyzer input and the pump suction to the analyzer outlet.
 - Tubing connected to the pump outlet should be run to drain.
 - Provide power to the CSV module using the provided power supply.
- 8) Specify the calibration standard levels to be performed. All three available ppb concentration levels are enabled by default, indicated by the checkmark (✓) preceding them. Disable any unwanted levels by pressing the **Up** and **Down Keys** to select the desired concentration, then pressing **Enter** to edit and **Up** and **Down** toggle it on and off. At least two levels must be selected, however.



Fig 6-1 : Calibration Standard Criteria

- 9) After specifying a given ppb concentration level, press **Enter** to highlight the concentration value. Using the **Up** and **Down Keys**, enter the actual TOC value for the given standard concentration as it appears on the **Certificate of Analysis** and press **Enter** to select the final value. Repeat this procedure for all calibration standard levels selected.
- 10) Also highlight the **# of reps** and specify the number of replicates to be performed at each level. Press **Up** and **Down Keys** to toggle through the available selections (1–3). Typically, the more replicates, the more accurate the calibration results. With the desired number replicates displayed, press **Enter**.

Note:

*Calibration requires at least two **Replicates** at two levels of **Standards**. The concentration of **Standards** used should bracket the concentration of the samples to be analyzed. Three **Standards** with three **Replicates** each is recommended for the best accuracy of calibration.*

- 11) Press **Enter**. The analyzer will ask if the “C of A” values have been entered. If not, press **Esc** to enter the “C of A” values: once they are properly entered, press **Enter** to continue.
- 12) If any changes must be made to the standard concentrations or the number of replicates, press **Esc** followed by **Enter** to abort the procedure. Immediately press **Enter** at the **TOC Calibrate Menu** to re-enter the **Standard Selection Menu**.
- 13) Install the blank bottle at the prompt. Press **Enter** and its contents are sampled and analyzed. The results of each of the analysis replicates are reported.
- 14) Press **Enter** to view the average of the blank replicates, which establishes the reference for the calibration, then press it again to continue.
- 15) Disconnect the blank bottle and install the requested standard (250, 500 or 750 ppb). Press **Enter** and its contents are sampled, analyzed and reported.
- 16) Repeat [step 15](#) for each of the selected standard levels. The blank average is subtracted from each replicate and the results for each are displayed once all analyses have been completed. Note that only one blank is analyzed, not one blank per calibration level.

Blank=XX
250 ppb Std=XXXX
500 ppb Std=XXXX
Press Enter

Fig 6-2 : Calibration Data

- 17) Press **Enter** to display the correlation coefficient. The instrument is suitable for measuring TOC in HPW if the slope change is within $\pm 15\%$ of the factory calibration.



Fig 6-3 : TOC Calibration Results

- 18) Press **Enter** to accept the new calibration and initiate a printout of the data. If the percent change in the slope exceeds $\pm 15\%$ of factory calibration, the calibration is deemed "unacceptable." An opportunity to repeat the calibration procedure using new sucrose standards will be given.
- 19) Once the calibration procedure is complete, remove the CSV Module and return the inlet and out lines to their original state.

A printout or display of the calibration information also is available through the **Data History Menu** selection (see "[Data History](#)" on page 95).

TOC600 Analyzer		
S/N xxxxx		
ID: 1 Name: SENSOR NAME		
TOC Calibration		
Passed on 07/31/2006 10:37		
Analyte	Replicates	Average
Blank	011 012 013	012 ppb
250 std	251 252 253	252 ppb
500 std	501 502 503	502 ppb
750 std	751 752 753	752 ppb
Correlation Coefficient = 0.9999		
Calibration Accepted		

Fig 6-4 : Sample TOC Calibration Printout

6.3 TOC Validation

The principles and procedure for performing a TOC validation are essentially the same as those used to perform a calibration. The intent of validation is to check the accuracy of the calibration, thereby ensuring that the TOC600 Analyzer measures samples reliably. Validation can be either a single-point analysis or multipoint analysis and the standard concentrations are user-selected.

Note:

Refer to Standard Operating Procedure (SOP) #TOC600–5A for complete instructions on performing this procedure.

To perform a TOC validation:

- 1) With the desired Analyzer selected in any View, press the **Manual Key** to access its menu selections.
- 2) Use the **Up** and **Down Keys** to specify **Calibrations**.
- 3) Press **Enter** to display its submenu.

CAUTION:

In a networked environment (see “[Network Installation](#)” on page 35), confirm the instrument’s Serial Number before proceeding. Operation of the wrong Analyzer could result in water leakage when the inlet and outlet water lines are removed during this procedure.

- 4) Use the **Up** and **Down Keys** to specify **Validate**. If the chosen Analyzer is connected to an Anet network on which other instruments reside, the analyzer will prompt to confirm that it is the correct instrument by verifying its serial number. The Analyzer will begin a

temperature stabilization process, its duration depending on the sample water temperature. The actual time required is displayed and counted down.

- 5) Press **Enter** to continue.
- 6) Connect the CSV Module by attaching the CSV Module to the analyzer.
 - Connect the fluid tubing from the standards bottle to the analyzer input and the pump suction to the analyzer outlet.
 - Tubing connected to the pump outlet should be run to drain.
 - Provide power to the CSV module using the provided power supply.
- 7) Specify the validation standard levels to be performed. A 500 ppb TOC sucrose concentration level is enabled by default, indicated by the checkmark preceding it.

Enable any other levels by pressing the **Up** and **Down Keys** to select the desired concentration, then pressing **Enter** to edit and **Up** and **Down** toggle the checkmark on and off. At least one validation level must be selected.

- 8) After specifying a given ppb concentration level, press **Enter** to highlight the concentration value. Using the **Up** and **Down Keys**, enter the actual TOC value for the given standard concentration as it appears on the **Certificate of Analysis** and press **Enter** to select the final value. Repeat this procedure for all validation standard levels selected.



Fig 6-5 : Validation Standard Criteria

- 9) Also highlight the **# of reps** and specify the number of replicates to be performed at each level. Press **Up** and **Down Keys** to toggle through the available selections (1–3). Typically, the more replicates, the more accurate the validation results.
- 10) Press **Enter**. The analyzer will ask if the “C of A” values have been entered. If not, press **Esc** to enter the “C of A” values: once they are properly entered, press **Enter** to

continue. Press **Enter** again to toggle through the available replicate selections (1–3). With the standard and number of replicates displayed, press **Enter**.

- 11) If any changes must be made to the standard concentrations or the number of replicates, press **Esc** followed by **Enter** to abort the procedure. Immediately press **Enter** at the **Validate Menu** to re-enter the **Standard Selection Menu** and continue with TOC validation.
- 12) Install the blank bottle at the prompt. Press **Enter** and its contents are sampled and analyzed. The results of each of the analysis replicates are reported.

```
Rep #1 = xxx ppb
Rep #2 = xxx ppb
Rep #3 = xxx ppb
Press Enter
```

Fig 6-6 : Analysis Replicates

- 13) Press **Enter** to view the average of the blank replicates, which establishes the reference for the validation, then press it again to continue. Note that only one blank is analyzed, not one blank per validation level.

```
Blank ave=xxx

Press Enter
```

Fig 6-7 : Blank Average

- 14) Remove the blank bottle and insert the requested standard bottle. Press **Enter** and its contents are sampled, analyzed and reported.
- 15) Repeat [step 13](#) for each of the selected validation standard levels. The blank average is analyzed only once during the validation process and is subtracted from each replicate average. The results for each are displayed once all analyses have been completed.

```
xxx ppb std
response=XXX ppb
deviation=XX%
Press Enter
```

Fig 6-8 : Analysis Results



Fig 6-9 : TOC Validation Results

- 16) Press **Enter** three times. Each time **Enter** is pressed, the next validation level results are averaged then reported in the form of a **ppb response** and **deviation percentage**. The instrument passes the validation test if all responses have a deviation of less than 15% from the given standard value.
- 17) Press **Enter** again to accept the test results and initiate a printout of the data. If the response deviation exceeds $\pm 15\%$, the corresponding results are displayed and the validation is deemed "*unacceptable*." The opportunity to repeat the validation procedure using a new sucrose standard will be given.
- 18) Once the validation procedure is complete, remove the CSV Module and return the inlet and outlet lines to their original state.

A printout or display of this validation information also is available through the **Data History Menu** selection (see "[Data History](#)" on page 95).

TOC600 Analyzer S/N xxxxx ID: 1 Name: SENSOR NAME		
TOC Validation Passed on 07/31/2006 12:34		
Analyte	Replicates	Average
Blank	011 012 013	012 ppb
500 std	501 502 503	502 ppb
Response = 490 ppb		
Deviation = -2%		

*Fig 6-10 : Sample Single-Point
TOC Validation Printout*

TOC600 Analyzer S/N xxxxx ID: 1 Name: SENSOR NAME		
TOC Validation Passed on 07/31/2006 12:34		
Analyte	Replicates	Average
Blank	011 012 013	012 ppb
250 std	271 276 278	275 ppb
500 std	501 502 503	502 ppb
750 std	761 773 778	771 ppb
250 ppb std response = 247 ppb		
250 ppb std deviation = -1%		
500 ppb std response = 488 ppb		
500 ppb std deviation = -2%		
750 ppb std response = 643 ppb		
750 ppb std deviation = -1%		
Deviation limit = 15%		
Validation accepted		

*Fig 6-11 : Sample Three-Point
TOC Validation Printout*

6.4 Conductivity Calibration

Conductivity calibration provides a confirmation of the accuracy of the conductivity values reported by the TOC600. The calibration verifies the cell constant by measuring a solution of known conductivity according to USP Method <645>. The instrument's meter accuracy must be within 0.1 $\mu\text{S}/\text{cm}$ and its cell constant must be known to be within $\pm 2\%$, therefore the conductivity solution measurement must be within $\pm 2\%$ of the reported label concentration.

Note:

Refer to Standard Operating Procedure (SOP) #TOC600-3 for complete instructions on performing this procedure.

To perform a conductivity calibration:

- 1) With the desired Analyzer selected in any View, press the **Manual Key** to access its menu selections.
- 2) Use the **Up** and **Down Keys** to specify **Calibrations**.
- 3) Press **Enter** to display its submenu.

- 4) Use the **Up** and **Down Keys** to specify **Calibrate**.

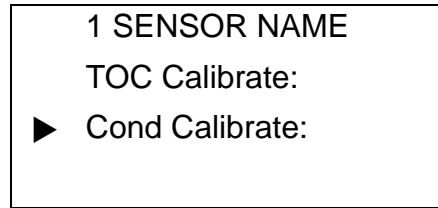

Fig 6-12 : Calibrate Menu

- 5) Select **Cond Calibrate** from the subsequent screen and press **Enter**. If the chosen Analyzer is connected to an Anet network on which other instruments reside, the analyzer will prompt to confirm that it is the correct instrument by verifying its serial number.

Note:

In a networked environment (see "Network Installation" on page 35), confirm the instrument's Serial Number before proceeding.

The Analyzer will begin a temperature stabilization process, its duration depending on the sample water temperature. The actual time required is displayed and counted down.

- 6) Press **Enter** to continue.
- 7) At the prompt, install the CSV Module and the conductivity standard vial and press **Enter**.
- 8) Three replicates are run and the results are reported in **µS/cm**. The results are displayed once all analyses have been completed. The instrument passes the conductivity test if the deviation between the actual value of the solution and the measured result is less than $\pm 5\%$ from the previous calibration or $\pm 10\%$ from the factory calibration.

Note:

USP Method <645> requires the cell constant be known to within $\pm 2\%$. To ensure this is the case, the cell constant is adjusted to the value of the conductivity standard and, therefore, is always within $\pm 2\%$. If the measured values are greater than $\pm 10\%$ of the original factory value, or $\pm 5\%$ of the previous calibration, an alarm message is displayed.

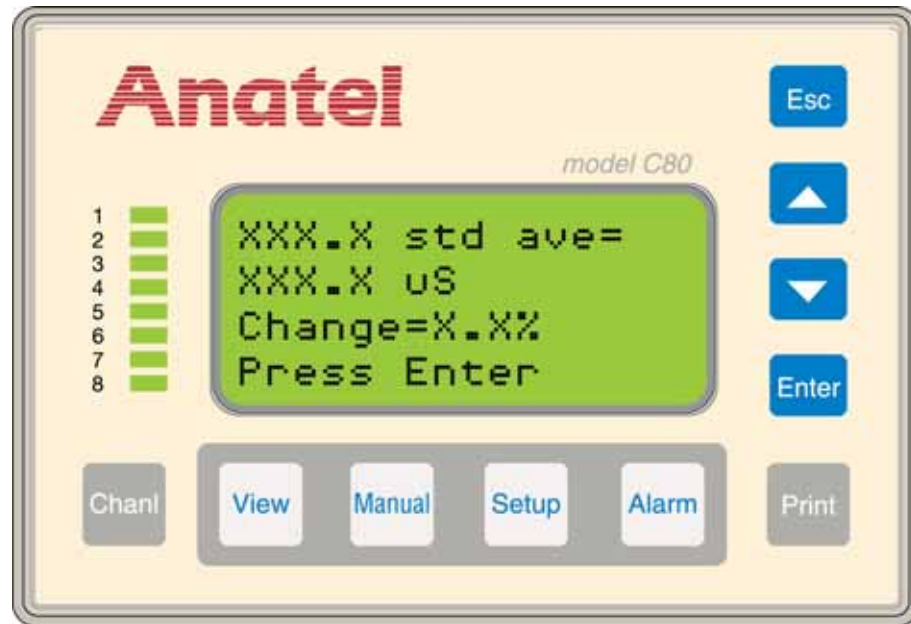

Fig 6-13 : Conductivity Calibration Results

- 9) Discard the results or press **Enter** to save the test results and initiate a printout of the data at the prompt. If the results exceed the test criteria, the calibration is *"unacceptable."* An opportunity to repeat the procedure using a new conductivity standard will be presented.
- 10) Once the conductivity calibration procedure is complete, remove the CSV Module and return the inlet and outlet lines to their original state.

A printout or display of this information also is available through the **Data History Menu** selection (see ["Data History" on page 95](#)).

TOC600 Analyzer		
S/N xxxxx		
ID: 1 Name: SENSOR NAME		
Conductivity Calibration		
Passed on 07/31/2006 13:25		
Standard	Replicates	Average
103 uS	104 105 103	104 uS
Meter = X.X uS/cm		
Slope Change = x.x%		
Slope Change Limits:		
5% from previous calibration		
10% from factory calibration		
Calibration Accepted		

*Fig 6-14 : Sample Conductivity
Calibration Printout*

6.5 System Suitability

System suitability provides a confirmation of the performance and efficiency of the TOC600. The procedure compares the average of a series of TOC measurements from an easy-to-oxidize working standard (in the form of sucrose) to the average of a corresponding series of measurements of a hard-to-oxidize system suitability solution (in the form of 1,4-benzoquinone). The response efficiency (RE) should be within 85% to 115%.

Note:

Refer to Standard Operating Procedure (SOP) #TOC600-2A for complete instructions on performing this procedure.

To determine system suitability:

- 1) With the desired Analyzer selected in any View, press the **Manual Key** to access its menu selections.
- 2) Use the **Up** and **Down Keys** to specify Calibrations.
- 3) Press **Enter** to display its submenu.
- 4) Use the **Up** and **Down Keys** to specify **Suitability**. If the chosen Analyzer is connected to an Anet network on which other instruments reside, the analyzer will prompt to confirm that it is the correct instrument by verifying its serial number. The Analyzer will begin a temperature stabilization process, its duration depending on the sample water temperature. The actual time required is displayed and counted down.

CAUTION:

In a networked environment (see “Network Installation” on page 35), confirm the instrument’s Serial Number before proceeding.

- 5) Press **Enter** to continue and wait while the sample temperature stabilizes.
- 6) Connect the CSV Module.
- 7) Enter the certified sucrose and 1,4-benzoquinone standard values from the **Certificate of Analysis** in the System Suitability Kit at the prompt.
- 8) Press **Enter** to enable the Controller’s Edit Mode and the flashing block cursor becomes an underscore.

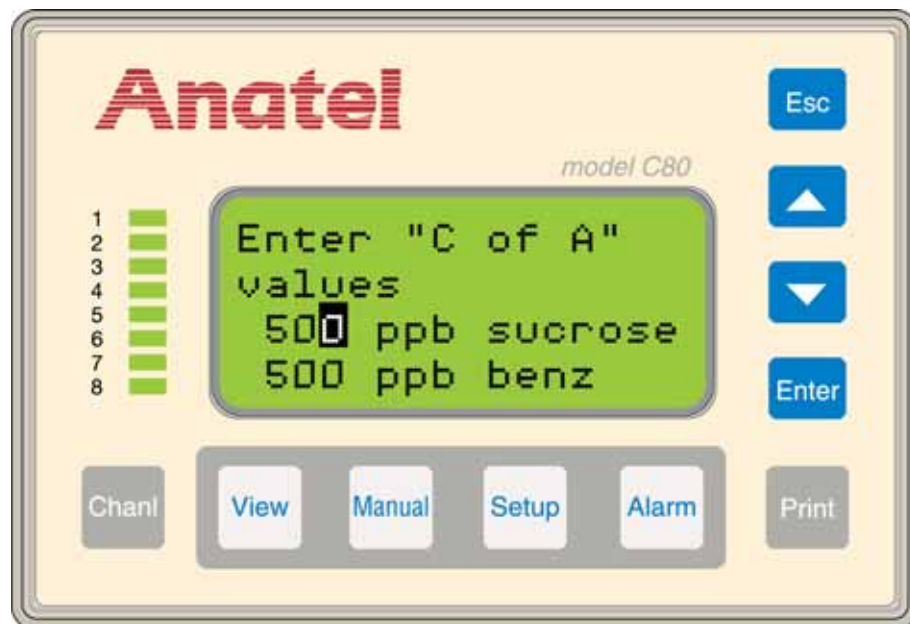

Fig 6-15 : Certificate of Analysis Values

- 9) Use the **Up** and **Down Keys** to scroll until the sucrose standard value found on the **Certificate of Analysis** is displayed.

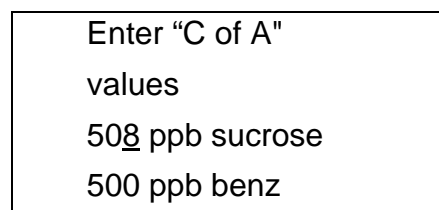

Fig 6-16 : Certificate of Analysis Displayed

- 10) Press **Enter** to retain the setting and the cursor advances to the 1,4-benzoquinone standard.
- 11) Again use the **Up** and **Down Keys** to enter the certified 1,4-benzoquinone standard value from the **Certificate of Analysis**, then press **Enter**.

- 12) Press **Enter** to confirm both **Certificate of Analysis** values have been properly entered.
- 13) At the prompt, connect the blank bottle and power on the CSV Module.
- 14) Press **Enter** and its contents are sampled and analyzed. The results of each of the analysis replicates are reported.

Rep #1 = xxx ppb
 Rep #2 = xxx ppb
 Rep #3 = xxx ppb
 Press Enter

Fig 6-17 : Analysis Replicates

- 15) Press **Enter** to view the average of the blank replicates, which establishes the reference for the test, then press it again to continue.

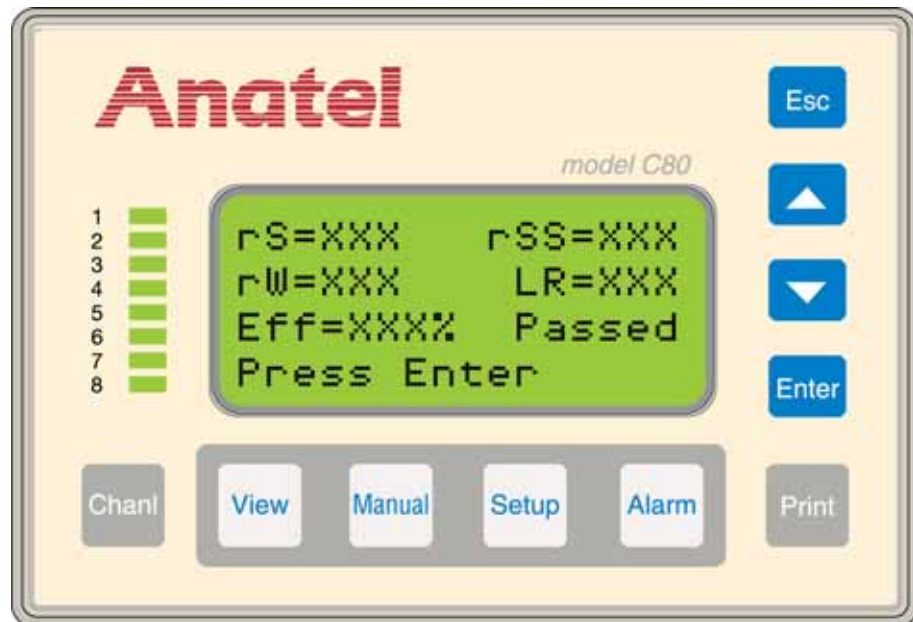

Fig 6-18 : System Suitability Results

- 16) Remove the blank bottle and insert the requested sucrose standard bottle. Press **Enter** and its contents are sampled and analyzed. The sucrose replicates are displayed once all analyses have been completed. Press **Enter** to view the average of the sucrose replicates.
- 17) Press **Enter** and then remove the sucrose standard and install the 1,4-benzoquinone standard.
- 18) Press **Enter** to sample, analyze and then average the 1,4-benzoquinone standard. The 1,4-benzoquinone replicates are displayed once all analyses have been completed. Press **Enter** to view the average of the 1,4-benzoquinone replicates.

- 19) Press **Enter** and the results of the system suitability test are reported:

r_s	is the average TOC response for the sucrose standard C.
r_{ss}	is the average TOC response for the 1,4-benzoquinone system suitability standard.
r_w	is the average TOC response for the standards blank.
LR	is the limit response of the instrument.
R_E	is the TOC response efficiency of the Analyzer which is calculated by the formula: $100 [(r_{ss} - r_w) / (r_s - r_w)]$

The instrument passes the system suitability test if the response efficiency is no less than 85% and no more than 115% of the limit response for the sucrose standard.

Note:

Because the sucrose and 1,4-benzoquinone standards cannot be made to exactly 500 ppb, the reported sucrose and 1,4-benzoquinone responses are corrected with the Certificate of Analysis values as follows:

$$\text{Corrected Response} = \text{Raw Response (ppbC)} \left(\frac{500}{\text{C of A Value}} \right)$$

- 20) Press **Enter** to save the test results and initiate a printout of the data. If the limit response exceeds the current TOC alarm limit, adjust the instrument's **Alarm Limit** to the calculated limit response. Press the appropriate key to continue.

Set TOC alarm
limit equal to
Limit Response
Enter=Yes Esc=No

Fig 6-19 : Adjust Alarm Limit

- 21) Once the system suitability procedure is complete, disconnect the CSV Module and return the inlet and outlet water lines to their original state.

A printout or display of this system suitability information also is available through the **Data History Menu** selection (see "[Data History](#)" on page 95).

TOC600 Analyzer		
S/N xxxxx		
ID: 1 Name: SENSOR NAME		
System Suitability Test		
Passed on 07/31/2006 14:37		
Analyte	Replicates	Average
rW	094 094 096	095 ppb
508 rS	533 547 553	544 ppb
511 rSS	545 563 565	558 ppb
Limit response (rS-rW) = 449 ppb		
Suitability resp (rSS-rW) = 463 ppb		
Response efficiency = 103%		
Efficiency limit = 85% to 115%		

*Fig 6-20 : Sample System
Suitability Printout*



WARNING

In the event of instrument failure, the sample discharge may contain 1,4-benzoquinone, which is a hazardous substance. Take appropriate precautions when handling sample discharge.

6.6 Data History

The results of TOC600 Analyzer calibration and validation procedures are available for review or printout at any time through the **Data History Menu**.

Note:

Data History screens and printouts are identical to those produced during the calibration and validation.

To access saved data:

- 1) With the desired Analyzer selected in any View, press the **Manual Key** to access its menu selections.
- 2) Use the **Up** and **Down Keys** to specify **Calibrations**.
- 3) Press **Enter** to display its submenu.
- 4) Use the **Up** and **Down Keys** to specify **Data History** and press **Enter**.

- 5) Choose the desired test category (**Validation, System Suitability, TOC Calibration or Conductivity Calibration**) and the test type (**Last Accepted or Last Done**). Press **Enter** to display it.

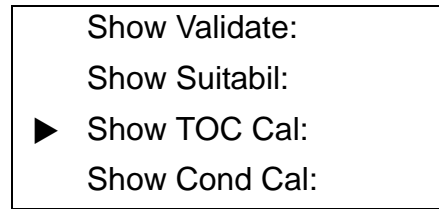

Fig 6-21 : Show TOC Cal

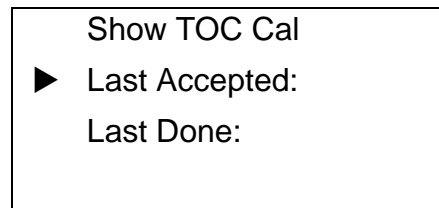

Fig 6-22 : Last Accepted

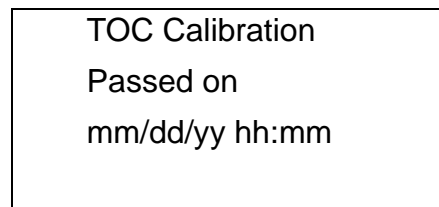

Fig 6-23 : Data History Screen

- 6) Press **Enter** repeatedly to display the average as well as the individual replicate results for each analysis, followed by the results of the test.
- 7) The option of printing the test data for the most recent or all (up to five) tests will be given. The last five test results for each test category are retained in the TOC600 Analyzer's **Data History** regardless of whether they passed or failed. The **Last Accepted** test that passed also is saved.
- 8) Press **Esc** repeatedly to exit this function and return to the normal display.

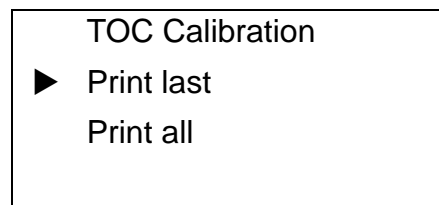

Fig 6-24 : Data History Print

7 TOC600 Analyzer Alarms

7.1 General Information

An Analyzer's TOC level can be monitored for fluctuations, any excursion triggering an alarm condition. The alarm limit can be independently defined for each instrument.

The user is alerted to any TOC limit excursions on the C80 Controller by flashing its entire LCD display, as well as the affected instrument's Channel LED. When enabled, an audible beeper also sounds to provide additional warning. A hardcopy printout of the excursion is generated automatically and the Analyzer's **Digital Output #1** port may be used to transmit its alarm status to a compatible device (see ["Digital Outputs" on page 140](#)).

The TOC600 Analyzer alarm reporting facility also is used to report any detected Analyzer problems such as a defective UV lamp or an excessively low sample temperature (see ["Alarm Codes" on page 165](#)). Summary data on any limit excursion or Analyzer alarms are displayed on the Controller by pressing the **Alarm Key**; detailed information is available on the printout.

7.2 Software Setup

There are two alarm variables which can be defined by the user.

- **Alarm Setup** specifies the level of the limit excursion that triggers an alarm condition.
- **Beeper Setup** enables and disables the Controller's audible alarm.

7.2.1 Alarm Setup

Default: TOC Alarm/500 ppb

The **Alarm Setup** parameter enables the alarm limits for the TOC600 Analyzer and, in the case of a TOC alarm, defines the limit at which the indication is triggered.

To access the Analyzer's **Alarm Setup** parameters:

- 1) With the desired Analyzer selected in any View, press the **Setup Key** to display its menu selections.

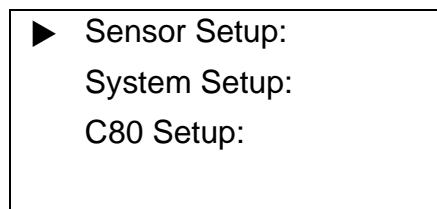

Fig 7-1 : Alarm Setup Menu

- 2) Use the **Up** and **Down Keys** to specify **Sensor Setup**.
- 3) Press **Enter** to display the **Sensor Setup Menu**.

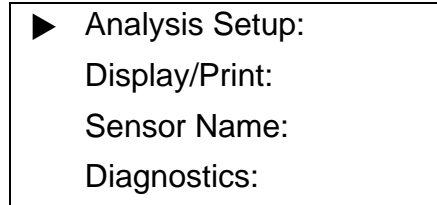

Fig 7-2 : Sensor Setup Menu

- 4) Similarly specify and select **Analysis Setup**.

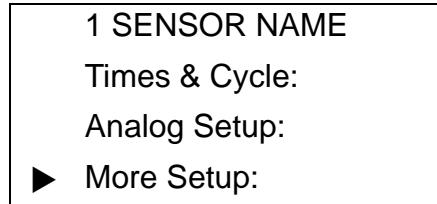

Fig 7-3 : Analysis Setup Menu

- 5) Specify and select **More Setup**.

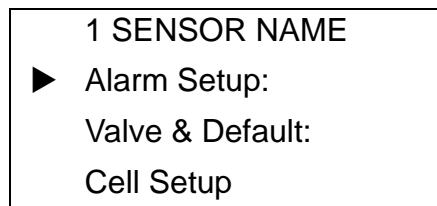

Fig 7-4 : More Setup Menu

- 6) Specify and select **Alarm Setup** to display its submenu.

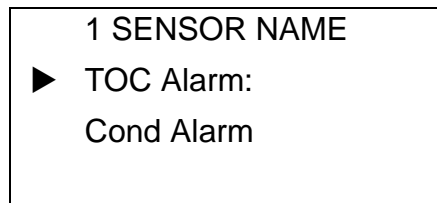

Fig 7-5 : Alarm Setup Menu

TOC Alarm Triggers an alarm indication when the Analyzer's reported TOC reading exceeds its specified limit.

Cond Alarm Triggers an alarm when the instrument's uncompensated conductivity exceeds the USP limit.

- 7) Use the **Up** and **Down Keys** to choose the desired alarm type, indicated by an arrow.
- 8) Press **Enter** to toggle the **Cond Alarm** selection on (preceded by a checkmark) and off in order to enable and disable this type of alarm (see "[Uncompensated Conductivity Alarms](#)" on page 102). Enabling the **TOC Alarm** type causes the corresponding **TOC Alarm Limit** to be displayed.

Note:

A Cond Alarm only appears if Uncompensated and Conductivity uS/cm both are checked in the **Display Units Menu** (see “Display Units” on page 54).

- 9) Use the **Up** and **Down Keys** to specify which digit is to be changed.
- 10) Press **Enter** to enable the Controller’s Edit Mode and the flashing block cursor becomes an underscore.

1 SENSOR NAME
 TOC Alarm Limit
 0500 ppb
 ▲/▼ to change

Fig 7-6 : Change Alarm Limit

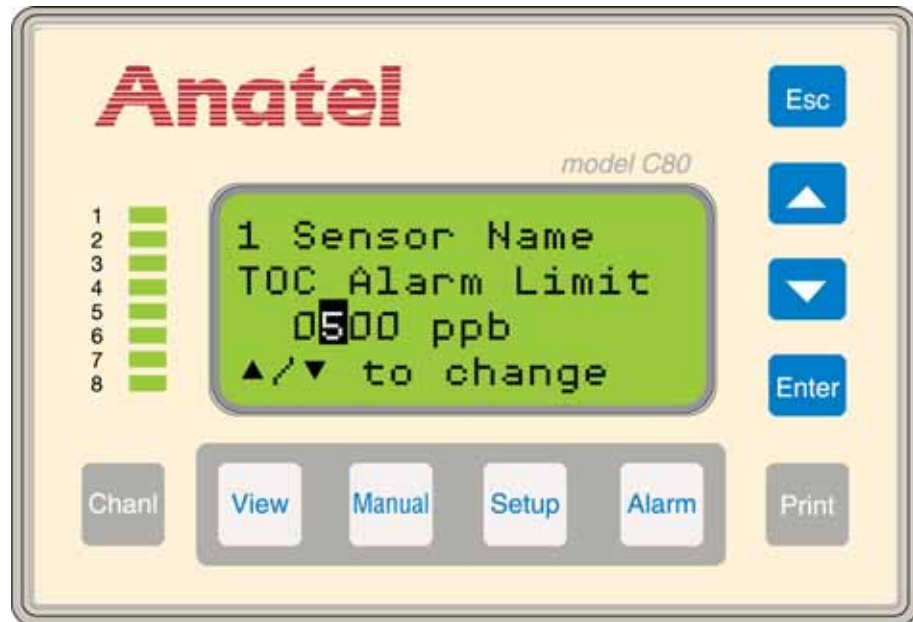

Fig 7-7 : TOC Alarm Limit Screen

- 11) Again use the **Up** and **Down Keys** to scroll until the desired value is displayed.
- 12) Press **Enter** to retain the pair’s setting.
- 13) Repeat the editing process with the other pair of digits, if necessary, to specify the Analyzer’s **TOC Alarm Limit (0000 to 1000 ppb)**. Setting the **Limit** to **0000** disables the alarm.

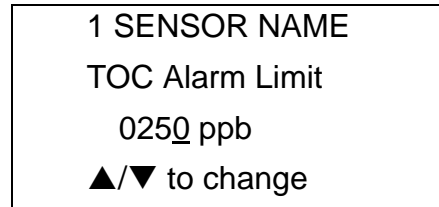

Fig 7-8 : Alarm Limit Changed

- 14) Press **Esc** repeatedly to exit this function and return to the normal display.

7.2.2 Beeper Setup

Default: Enabled

The **Beeper Setup** is a global parameter for sounding the Controller's audible alarm in the event of a TOC limit excursion by one of its connected instruments. The alarm continues to sound until acknowledged by pressing the **Alarm Key**.

To enable/disable the Controller's Beeper:

- 1) With any Channel View displayed, press the **Setup Key** and its menu selections are presented.
- 2) Use the **Up** and **Down Keys** to specify **C80 Setup**.

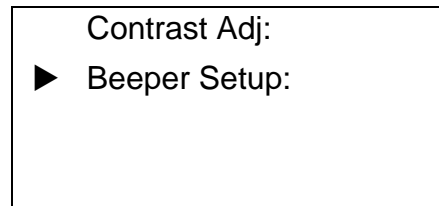

Fig 7-9 : Beeper Setup Menu

- 3) Press **Enter** to access its submenu.
- 4) Specify **Beeper Setup** and press **Enter** to display its parameter screen:

Enabled	The Controller's audible alarm is triggered by a TOC limit excursion.
Disabled	The Controller's alarm will not sound when any of its connected Analyzers experiences a TOC limit excursion.
- 5) Specify the desired **Beeper Setup**, then press **Enter** to save the setting and exit the screen.



Fig 7-10 : C80 Alarm Beeper Screen

7.3 Alarm Reporting

The most common TOC600 Analyzer fault condition is an Analyzer that measures a TOC value greater than its specified **TOC Alarm** setting (see “[Alarm Setup](#)” on page 97). There are several ways an alarm condition is reported:

- The associated Controller’s LCD display flashes.
- The Analyzer’s Channel LED flashes red.
- If enabled, the Controller beeps an audible alarm.
- If connected to a printer, a printout is generated documenting the fault. A **High TOC Alarm Warning** is reported on a separate line and includes the limit that was exceeded:
High TOC Alarm: 560 ppb >[500 ppb]
- When connected, the signal at the Analyzer’s **Digital Output #1** port is pulled low (see “[Digital Outputs](#)” on page 140).

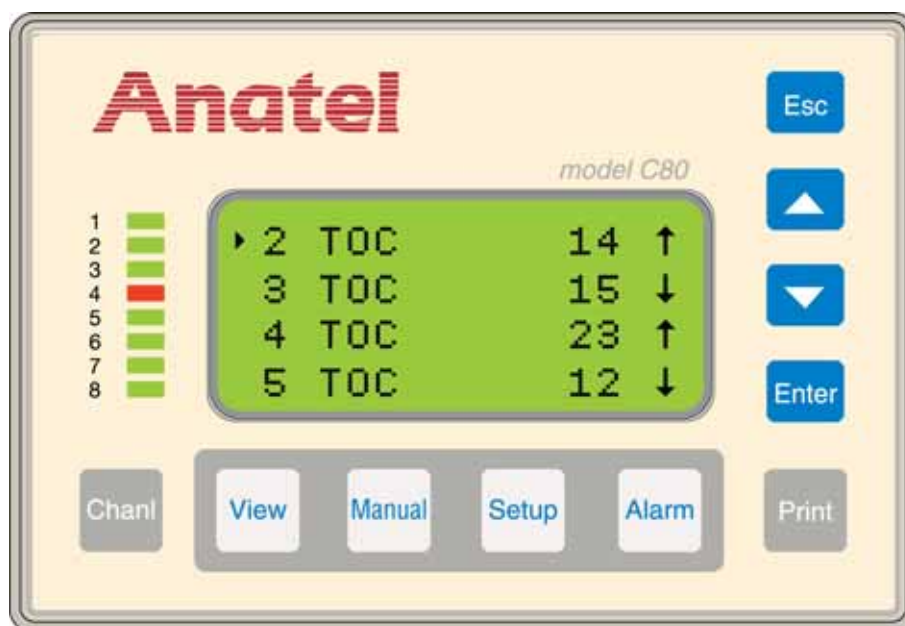

Fig 7-11 : Reported Sensor Alarm

In the example, the LED indicating the instrument on Channel #4 has changed from green to flashing red, indicating a TOC excursion. The user can acknowledge the alarm and display its summary status by pressing the **Alarm** Key.

The Controller LCD also is used to display Analyzer malfunctions, reported as Codes (see [“Alarm Codes” on page 165](#)). Different than a limit excursion, a Code indicates an electromechanical or analytical failure. The Analyzer’s Channel LED and the Controller’s display still flash, but there is no audible alarm (regardless of the **Beeper Setup**) to alert the user that there is a problem.

7.3.1 Uncompensated Conductivity Alarms

Alarms are reported for conductivity excursions only in the Uncompensated Mode (see [“Sensor Diagnostics” on page 172](#)) and require that **Conductivity uS/cm** and **Uncompensated** be selected in the **Display Units Menu**.

The actual (uncompensated) conductivity limits are in accordance with the specifications set forth in the method “<645> Water Conductivity” of the US. These temperature-based limits are shown in [Table 7-1](#).

Table 7-1 : Temperature-based Conductivity Limits

Temperature (°C)	Conductivity (µS/cm)	Temperature (°C)	Conductivity (µS/cm)
0	0.6	55	2.1
5	0.8	60	2.2
10	0.9	65	2.4
15	1.0	70	2.5
20	1.1	75	2.7
25	1.3	80	2.7
30	1.4	85	2.7
35	1.5	90	2.7
40	1.7	95	2.9
45	1.8	100	3.1
50	1.9		

The actual sample water temperature is rounded downward to the nearest 5° increment in order to establish the conductivity limit, thereby assuring any potential excursions are detected early. For example, if the measured water temperature is 24.5 °C, the 20 °C limit is applied and an alarm is generated if the conductivity exceeds 1.1 µS/cm.

For agreement among all data outputs on the System, TOC, conductivity and temperature values are all rounded to match the Controller's accuracy for alarm limit checking, display, printouts, and any digital outputs.

To access an TOC600 Analyzer's **Alarm Setup** parameters:

- 1) With the desired Analyzer selected in any View, press the **Setup Key** to display its menu selections.
- 2) Use the **Up** and **Down Keys** to specify **Sensor Setup**.
- 3) Press **Enter** to display the **Sensor Setup Menu**.
- 4) Similarly specify and select **Analysis Setup**.
- 5) Specify and select **More Setup**.
- 6) Specify and select **Alarm Setup** to display its submenu.



Fig 7-12 : Alarm Setup Menu

Note:

The Cond Alarm parameter does not appear unless the display was set to both **Conductv uS/cm** and **Uncompensated** (see “Display Units” on page 54).

- 7) Use the **Down Key** to select the **Cond Alarm** format for this Analyzer and press **Enter** to toggle the check mark “on,” indicating that uncompensated conductivity alarm monitoring has been enabled.
- 8) Press **Esc** repeatedly to exit this function and return to the normal display.

In the Auto TOC mode, the alarm limit is checked at the end of each analysis cycle. In the Purge mode, the limit is checked every 15 seconds.

When the uncompensated limit is exceeded, an alarm is generated and several things occur:

- The LED corresponding to the TOC600 Analyzer Analyzer’s Channel ID flashes red on all of its associated C80 Controllers.
- The alarm is logged and becomes available for display on any of those Controllers.
- If the Analyzer is attached to a local printer, a hard copy of the condition is generated containing the time of the excursion, the measured conductivity and temperature, and the USP conductivity limit exceeded. For example:

12:07 Alarm 1.45 μ S @ 33.2C >[1.4 @ 30C]

Excursions reported in subsequent analyses are output only at the normal user-specified interval (or in response to a percent change in the readings) unless the sample water conductivity falls below the specified limit. In that case, a new alarm report is output to ensure that each limit excursion is recorded.

- The Sensor's **Digital Output #2** is asserted to allow alarm annunciation to an external device (see "Hardware Setup" on page 140).

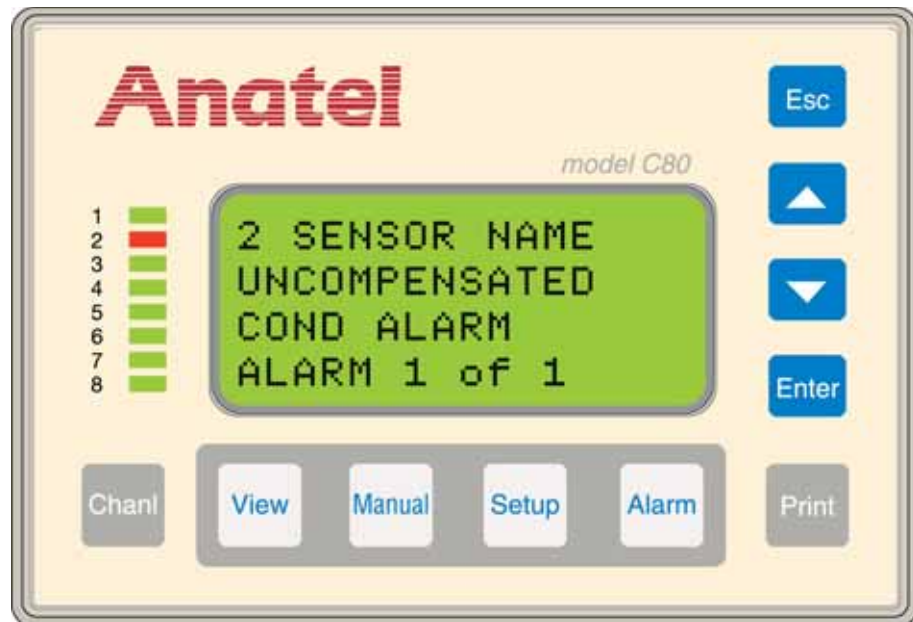

Fig 7-13 : Uncompensated Conductivity Alarm

7.4 Alarm Acknowledgement

A limit excursion is acknowledged by specifying the errant Analyzer and then pressing the **Alarm Key**. Acknowledgement stops the Controller's LCD from flashing, stops the flashing red Channel ID, and silences the audible warning. If more than one alarm has been detected, all must be acknowledged before these fault indications are terminated. The red Channel LED is restored to green when the Analyzer's TOC level falls below its set limit.

Acknowledgement presents the following alarm information on the Controller's LCD display:

- Line 1 The affected instrument's Channel ID and its user-entered **Name**.
- Line 2 The cause of the alarm.
- Line 3 The date and time the alarm was detected.
- Line 4 The current number of alarms logged for the displayed Analyzer.

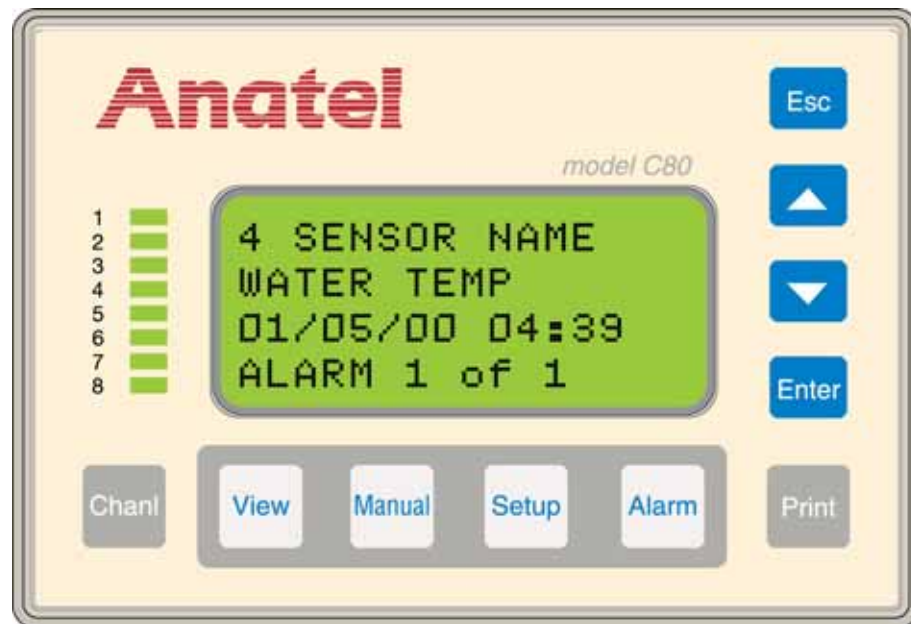

Fig 7-14 : Acknowledged Sensor Alarm

In the example, the message reports that the TOC level exceeded its specified alarm limit on Channel #4. In the event of multiple excursions, the date and the time each alarm was detected are displayed, as well as the total currently logged for the instrument.

Any additional (different) alarms for the Analyzer can be examined by pressing the **Up** and **Down Keys** to scroll through its log. Once displayed, Codes are erased but still available on the Analyzer's internal log (see "[Internal Log](#)" on page 111). The alarm status of the other Analyzers can be observed by pressing the **Alarm Key** repeatedly. If no fault conditions exist for a particular instrument, "No Codes" is reported.

The **Alarm Key** also is used to acknowledge TOC600 Analyzer Codes. When an Analyzer problem is detected, it displays the following information:

- Line 1 The affected instrument's Channel ID and its user-entered **Name**.
- Line 2 The Code number representing the problem.
- Line 3 A brief message describing the nature of the alarm.

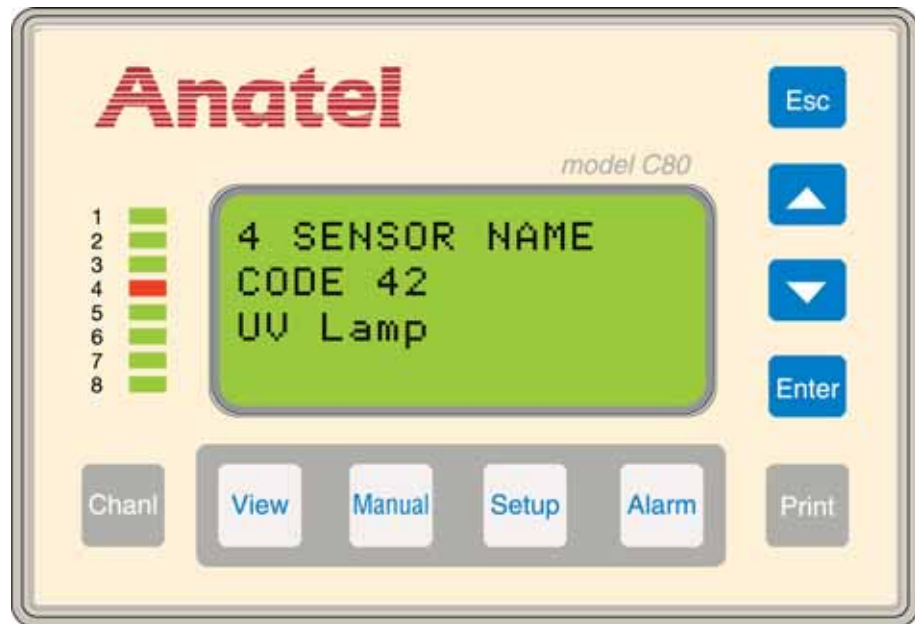

Fig 7-15 : Alarm Reporting

8 Printer Output

8.1 General Information

All TOC600 Analyzer are equipped with an output port for a local printer. Automatic hardcopy reports are generated periodically, although printouts detailing individual Analyzer and global Network information can be produced on demand through the **Print Key**. This function also furnishes access to the Analyzer's data log permitting the contents to be printed or its memory erased.

8.2 Hardware Setup

Printer connections are made to the PRINTER Port on the Analyzer's Connector Block. This RS-232C interface communicates at 1200 baud, 8 data bits, 1 stop bit and no parity. Three- or five-conductor cable is adequate for most serial interfaces (AWG 24 is recommended), depending on the particular printer.

Note:

Hach Ultra supplies the local printer's interface cable.



WARNING

To avoid electrical shock, always disconnect the instrument from its power source before attempting to access internal components.

Printer output connections are made on the Analyzer's I/O Connector Block as follows:

- 1) Turn the instrument OFF and disconnect the power cord from its source.
- 2) Remove the I/O Connector Block from the bottom of the Analyzer by loosening its four screws.
- 3) Loosen and remove the two screws that secure the metal strain relief plate.
- 4) Feed the interface wiring through one of the five holes at the end of the Connector Block cover and along the corresponding slot in the foam padding.

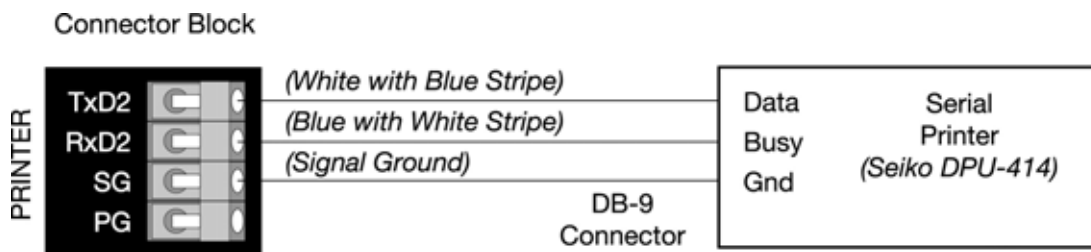

Fig 8-1 : External Printer Wiring

CAUTION:

The I/O Connector Block must be reinstalled correctly to conform to emissions specifications.

- 5) Make the necessary serial connections to the Analyzer's PRINTER port as shown.

- 6) Replace the metal strain relief plate.
- 7) Replace the I/O Connector Block on the bottom of the Analyzer, taking care not to pinch any wires, and secure it in place by tightening the screws.
- 8) Reconnect power and turn the Analyzer **ON**.

When using the Seiko Instruments Inc. DPU-414 Type II Thermal Printer, the electronic DIP switches are preset at the factory as shown in [Table 8-1](#).

Table 8-1 : Preset DIP Switches

DIP Switch 1			DIP Switch 2			DIP Switch 3		
Switch	Setting	Function	Switch	Setting	Function	Switch	Setting	Function
1	Off	Serial Input	1	On	40-Column Printing	1	On	8 Data Bits
2	On	High Print Speed	2	On	Backup Font Enabled	2	On	No Parity Setting
3	On	Autoloading Enabled	3	On	Normal Characters	3	Off	Even Parity
4	Off	Auto Linefeed Disabled	4	Off	Zero = Slash	4	On	Flow Control (XON/XOFF)
5	On	Enabled Setting	5	On	International Character Set = USA	5	On	1200 Baud
6	Off	Print Density (100%)	6	On	International Character Set = USA	6	Off	1200 Baud
7	On	Print Density (100%)	7	On	International Character Set = USA	7	On	1200 Baud
8	On	Print Density (100%)	8	Off	International Character Set = USA	8	Off	1200 Baud

To change any of these settings:

- 1) Turn the printer power switch **OFF**.
- 2) Restore power while pressing the **ONLINE** button. Release the button when a printout of the current settings begins.
- 3) Push the **ONLINE** button once again and **DIP SW1** is printed, prompting for changes on switches 1–8.
- 4) Enter the settings for **DIP Switch 1** by pressing **ONLINE** for **On** (enabled) and **FEED** for **Off** (disabled) for each of the switches 1-8 in succession. The **ONLINE** LED illuminates to indicate an “On” entry: the **OFFLINE** LED correspondingly indicates an “Off” entry.

Note:

Be sure to enter a setting for all eight switches because this setup mode cannot be cancelled once initiated.

- 5) Once all eight of the switches have been set, a printout prompts whether to “Continue” to repeat the procedure for **DIP Switch 2** and then **DIP Switch 3**, or “Write” the current settings to memory. Once saved, a printout is generated and the printer returns to normal operation.

CAUTION:

*Do not turn the printer off while it is saving settings. Wait until **Dip SW setting complete!** is printed before removing power.*

8.3 Software Setup

Hard copies of Analyzer data can be produced on demand and other print-related operations can be performed. The available print options include the following functions:

- The ability to print and examine the Analyzer's internal log.
- The capacity to print comprehensive Analyzer setup and factory configuration parameters.

8.3.1 Internal Log

Default: Data & Audit

Each TOC600 Analyzer's log protects against data loss by chronologically recording any events. An **Audit Only** selection in the **Log Setup Menu** records power cycles, alarm codes and parameter changes. The default setting of **Data & Audit** also stores analysis results and Purge Mode data. In either case, all events are time-stamped and the log is only updated when information is sent to the printer. Any parameter changes have an additional line containing the date and identifying the person who made the instrument change.

The log also tracks the Analyzer's available memory. The amount of data stored in the log depends on the **Log Setup** as well as the instrument's **TOC Print** (see "[Auto TOC Mode Printout](#)" on page 68) and **Purge Print** (see "[Purge Mode Printouts](#)" on page 71) settings. For example, with **Data & Audit** selected and sampling at one-minute intervals in the Purge Mode, the log will retain approximately two and a half days worth of information before it begins writing over the earliest data recorded; sampling every six minutes would hold about 16 days of data. With **Audit Only** selected and few changes made to the instrument, the log will store information for an indefinite period.

To access **Log** information:

- 1) With the desired Analyzer selected in any View, press the **Print Key** to access its submenu.
- 2) Select **Sensor Print** and then press **Enter** to display that menu.
- 3) Use the **Up** and **Down Keys** to specify **Log**.
- 4) Press **Enter** to display the available options:

Print Log	Generates a printout of all the data currently stored in the Analyzer's memory. Print All outputs all records: Print Range outputs only those records over a certain period of a specified time.
Memory Usage	Estimates the percentage of the Analyzer's memory log occupied by data.
Log Setup	Specifies the amount of information stored in the log. Data & Audit also includes all TOC analysis and Purge Mode data: Audit Only records only instrument events.

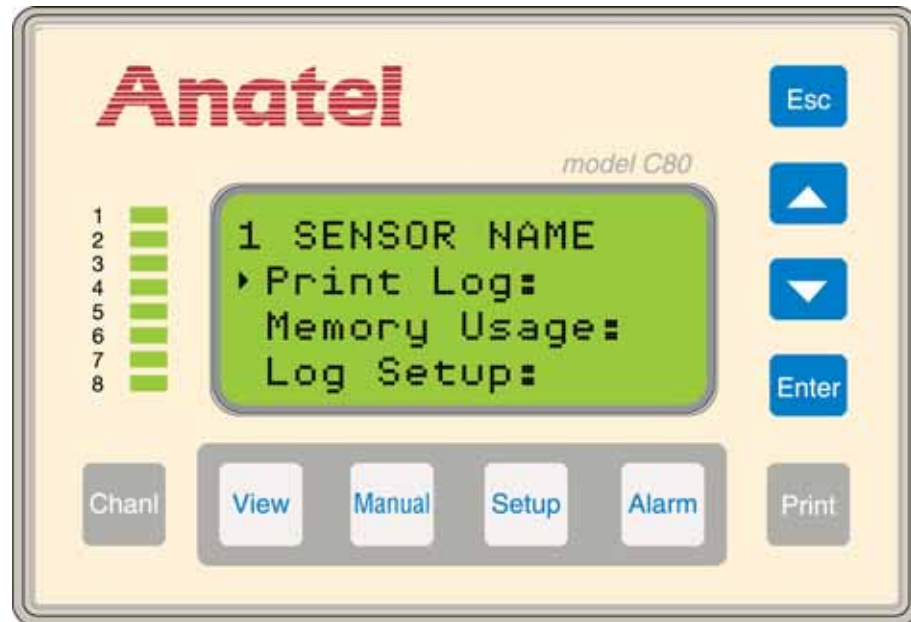

Fig 8-2 : Log Screen

- 5) Use the **Up** and **Down Keys** to specify the desired Log function.
- 6) Press **Enter** to perform the specified function.

If a **Print Range** has been specified, there may a slight delay before the default **Range** is displayed, depending on how full the data log is. During this delay, **??** is displayed in **Range** fields. If no data records are contained in the log over the specified range, zeros are displayed in the **Range** fields and no data will be printed. Once the default **Print Range** is displayed, the block cursor begins flashing to indicate that the span can be altered.

Print log range yymmdd hhmm from 000105 0800 to 000105 1700
--

Fig 8-3 : Print Range

Note:

The **Print Range** function is inactive when the Log Setup selection is set to "Audit Only."

TOC600 S/N XXXXX ID: 1 Name: SENSOR NAME						

07/31/2007						
TIME	TOC [PPB/HR]	%AL	TREND [PPB/HR]	RESIS UNCMP	TEMP °C	CRV TYP
16:14	137	27%	0	0.08	31.5	P3
16:17	137	27%	0	0.08	31.5	P3
16:20	139	28%	0	0.06	31.3	P3
16:23	139	28%	0	0.06	31.2	P3
16:26	138	28%	0	0.08	31.2	P3
16:29	139	28%	0	0.06	31.0	P3
16:32	138	28%	0	0.07	31.1	P3
16:35	136	27%	0	0.06	31.0	P3
16:38	137	27%	0	0.07	31.0	P3
16:41	138	28%	0	0.06	31.2	P3
16:44	140	28%	0	0.08	31.0	P3

Fig 8-4 : Sample Log Printout

- 7) Press **Enter** to enable the Controller's Edit Mode and the flashing block cursor becomes an underscore, indicating the year which starts the "from" date. The year must be between 1990 and 2050, inclusive. The year (yy) is interpreted as 20XX (2005, for instance) if it is less than 90; otherwise, it is treated as 19XX (such as 1998). The default **Range** includes the time span from the first to the last logged record.
- 8) Use the **Up** and **Down Keys** to scroll to the appropriate year and press **Enter** to advance to the month field.
- 9) Similarly specify the month and press **Enter**.
- 10) Repeat the procedure with the hour and minute settings, then specify the corresponding "to" date and time.
- 11) With the desired Range displayed in the "from" and "to" fields, press **Esc** and the logged records are output to the printer. The ongoing progress of the printout is displayed as a percentage.
- 12) Press **Esc** to exit this function and return to the **Log Menu**.
- 13) To change the **Log Setup** to include or exclude analysis and purge data, scroll down to that function and press **Enter**.

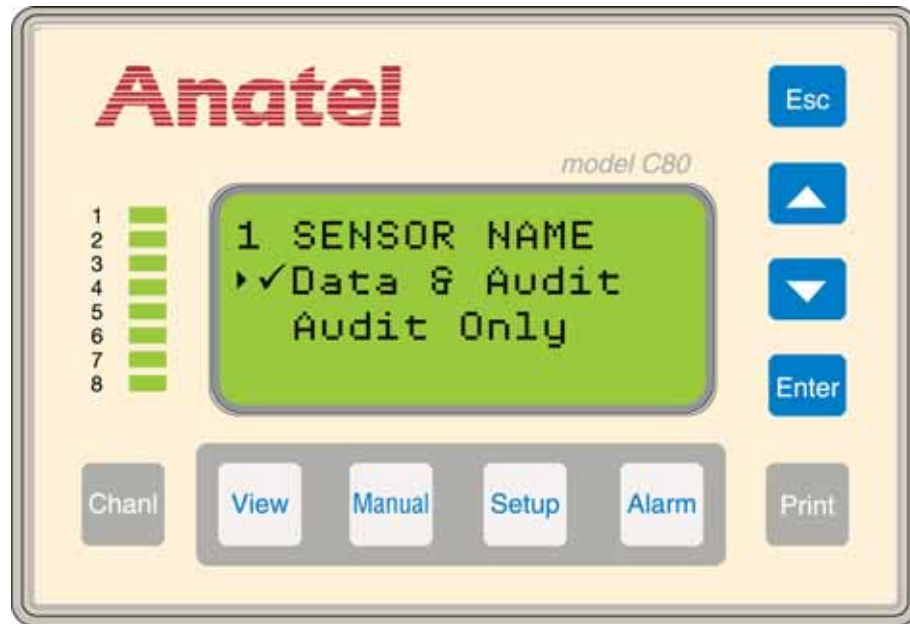

Fig 8-5 : Log Setup Screen

- 14) Use the **Up** and **Down Keys** to scroll to the appropriate selection and press **Enter**.
- 15) Press **Esc** repeatedly to exit this function and return to the normal display.

8.3.2 Printouts

The **Printouts** option provides detailed setup information on the individual instruments. These two hardcopy outputs list all of the Analyzer's operational parameters and its factory configuration parameters.

To generate **Printouts** of this parameter information:

- 1) With the desired Analyzer specified in any View, press the **Print Key** to access its menu.
- 2) Use the **Up** and **Down Keys** to select Sensor Print and then press **Enter**.

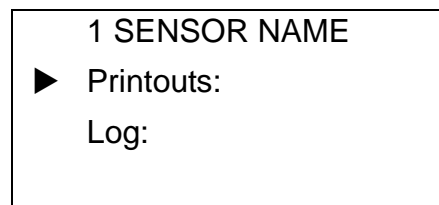

Fig 8-6 : Sensor Print

- 3) Specify **Printouts** and press **Enter** to display the available options

- | | |
|----------------|--|
| Print Setup | Generates a hard copy of all the Analyzer's current user-defined parameters. |
| Print Factory | Outputs a copy of the instrument's factory-programmed parameters. These values facilitate Analyzer service and cannot be changed by the user. The Controller display also reports the firmware Version, its time and date. |
| Print Cal/Suit | Outputs a copy of all the instrument's stored data histories. Individual Cal/Suit histories can be obtained through Data Histories (see "Data History" on page 95) and sample printouts may be found: <ul style="list-style-type: none"> • TOC Printout: "TOC Calibration" on page 80 • TOC Validation: "TOC Validation" on page 84 • Conductivity Calibration: "Conductivity Calibration" on page 88 • System Suitability: "System Suitability" on page 91 |

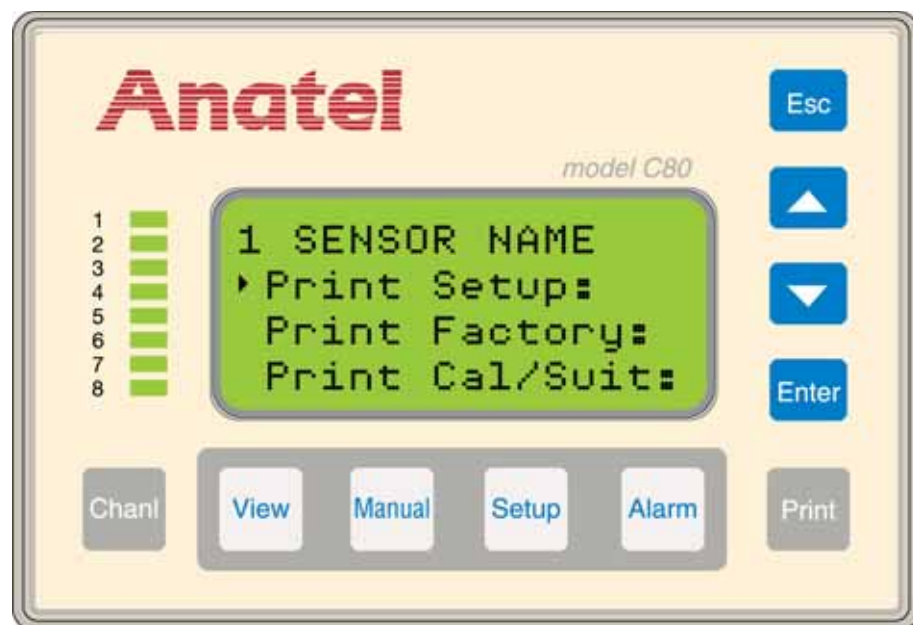

Fig 8-7 : Printouts Screen

- 4) Use the **Up** and **Down Keys** to specify the desired **Printout** function.

- 5) Press **Enter** to generate the specified output. The information in both **Printouts** is preceded by the following Analyzer-specific header data:
 - Model
 - Serial Number
 - Channel ID Number
 - User-entered Name
 - Current Date and Time

- 6) Press **Esc** repeatedly to exit this function and return to the normal display.

TOC600
S/N xxxxx
ID: 1 Name: SENSOR NAME
Sensor Parameter Settings
07/31/06 14:32:41

Sample Time = 00:01:00
Cycle Time = 00:00:00
TOC Alarm Limit = 500
ID Number = 1
ID Name = SENSOR NAME
Cycle Modes = TOC & IDLE
Sampling Mode = WATER SAVER
External DAC Module = INACTIVE
Res/Cond Units = uS/cm U
DAC Calib Output = INACTIVE
TOC Print Interval = CONTINUOUS
PURGE Print Interval = TIMED
Active Alarm = TOC
20mA I Range = 4-20 mA
DAC Error Output = Min Out
TOC Paper Saver %Change = 1
Purge Paper Saver %Change = 1
PURGE Timed Print = 00:01:00
TOC DAC Zero Scale = 000
TOC DAC Full Scale = 1000
User TOC Slope = 1.000
Resis/Cond DAC Zero-Scale = 000
Resis/Cond DAC Full-Scale = 020
Temp DAC Zero-Scale = 005
Temp DAC Full-Scale = 095
Digital Control = Disabled
Log = Data & Audit
User Cond Slope = 1.000

Fig 8-8 : Setup Printout

TOC600
S/N xxxxx
ID: 1 Name: SENSOR NAME

Factory Configuration
07/12/2006 14:35

Cal Date, Number: 01/31/06,90,1
Cal Gain, Offset: 0.067648,-0.001271
Thermistor Factor a: 0.0010295
Thermistor Factor b: 0.0002391
Thermistor Factor c: 1.568e-07
Sensor, Rev, Firmware Ver: xxx,x.xx
Checksum: 4341H

Fig 8-9 : Factory Printout

9 Analog Outputs

9.1 General Information

TOC600 Analyzers provide two methods for outputting signals to external analog devices. The first offers TOC data through the dedicated 4–20 mA port located on the instrument's Connector Block; the second outputs conductivity (or resistivity) and/or temperature data to optional External DAC (Digital-to-Analog Conversion) Modules via the Analyzer's DIAGNOSTICS port. The output from the DAC Module is a 4-20 or a 0-20 mA signal which then can be used by a variety of compatible analog devices.

This section describes how to establish hardware connections for the standard TOC output and the optional External DAC output as well as how to set the necessary operational parameters for each.

9.2 TOC Output

As noted, an analog signal corresponding to the Analyzer's TOC reading is always available via its 4-20 mA port. This current output may be converted to a voltage if desired by inserting a conversion resistor into the wiring scheme.

Software settings determine the analog output range in addition to its corresponding zero-scale and full-scale values. A user-specified signal also may be output to designate TOC600 Analyzer alarms.

9.2.1 Hardware Setup

The Analyzer can generate an isolated current output ranging from 4-20 or 0-20 mA that is proportional to its most recent TOC reading. This analog output drives resistances between 50 and 500 ohms, including the interconnecting cables. The signal can be converted to a voltage output by incorporating an appropriate conversion resistor as shown in [Table 9-1](#).

Table 9-1 : Conversion Resistors

Resistor	4–20 mA DC Voltage Range	0–20 mA DC Voltage Range
50Ω	0.2–1 VDC	0–1 VDC
250Ω	1–5 VDC	0–5 VDC
500Ω	2–10 VDC	0–10 VDC

Note that the precision of the resistor directly affects the accuracy of the data. A 1% wire-wound resistor or better is recommended. For maximum data integrity, the resistor should be mounted across the receiving device's input terminals.

TOC Analog output connections are made to the Analyzer's I/O Connector Block as follows:

**WARNING**

To avoid electrical shock, always disconnect the instrument from its power source before attempting to access internal components.

- 1) Turn the TOC600 Analyzer **OFF** and disconnect the power cord from its source.
- 2) Remove the I/O Connector Block from the bottom of the Analyzer by loosening its four screws.
- 3) Loosen and remove the two screws that secure the metal strain relief.
- 4) Feed the interface wiring through one of the five holes at the end of the Connector Block cover and along the corresponding slot in the foam padding.
- 5) Make the necessary positive and ground connections to the Analyzer's 4-20mA terminals.
- 6) Replace the metal strain relief plate.
- 7) Replace the I/O Connector Block on the bottom of the Analyzer, taking care not to pinch any wires, and secure it in place by tightening the screws.
- 8) Reconnect power and turn the Analyzer **ON**.

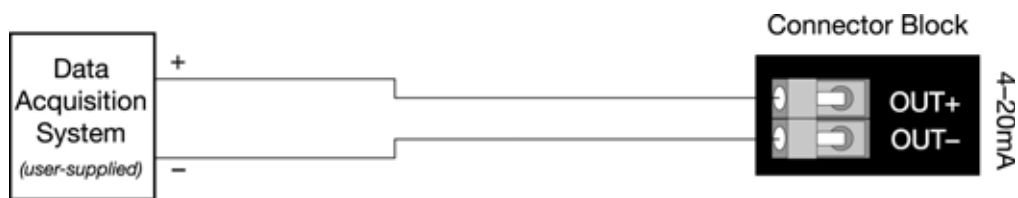

Fig 9-1 : Current Output Wiring

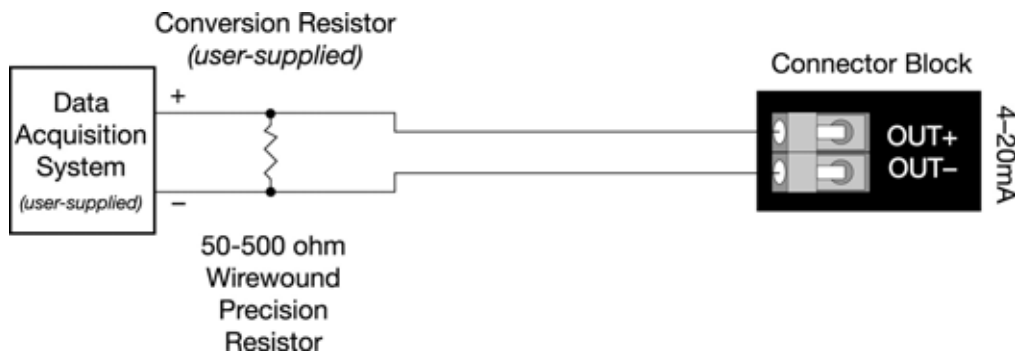

Fig 9-2 : Voltage Output Wiring

CAUTION:

The I/O Connector Block must be reinstalled correctly to conform to emissions specifications.

9.2.2 Software Setup

The analog signal generated at the conclusion of an analysis cycle is calculated based on the sample's reading and represents TOC in ppb. The transmitted signal remains constant until the next analysis cycle is complete. If a critical problem is encountered during a TOC analysis, the analog output goes to a pre-defined state. Setting the TOC output consists of:

- Specifying the analog output range.
- Defining the associated zero-scale and full-scale values that establish the resolution of that signal.
- Establishing the signal that is to be output in the event of an TOC600 Analyzer alarm.
- Activating the DAC Calibration Output, if desired.

All of the TOC600 Analyzer's analog parameters are defined through its **Analog Setup Menu**:

- 1) With the desired Analyzer selected in any View, press the **Setup Key** to display its submenu.

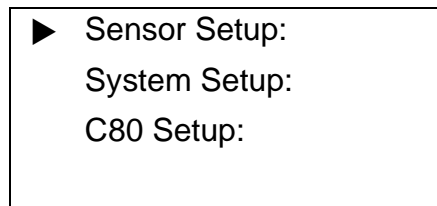

Fig 9-3 : Setup Menu

- 2) Use the **Up** and **Down Keys** to specify **Sensor Setup**.
- 3) Press **Enter** to display the **Sensor Setup Menu**.

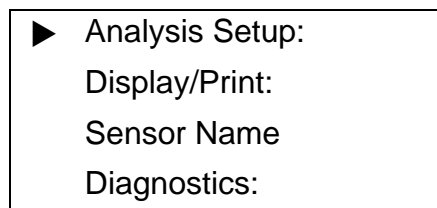

Fig 9-4 : Sensor Setup Menu

- 4) Specify **Analysis Setup** and then press **Enter** to access its submenu.
- 5) Specify **Analog Setup** and press **Enter** to display its parameter options.

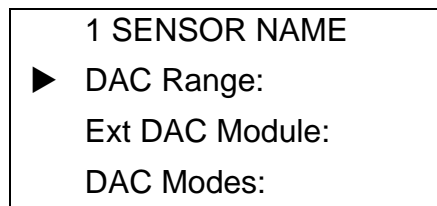

Fig 9-5 : Analog Setup

DAC Range	Sets the Analyzer's internal, and external, analog output range as 4-20 mA or 0–20 mA (see “ Analog Output Range ” on page 122). The limits of this range correspond to the zero-scale and full-scale values entered for TOC, conductivity or resistivity, and temperature (“ TOC Output Range ” on page 123).
Ext DAC Module	Enables the output to an External DAC Module (“ Optional Conductivity/Resistivity and Temperature Outputs ” on page 128).
DAC Modes	Allows access to the DAC Error Output and DAC Calibration Output settings (“ DAC Error Output ” on page 126).

DAC Range Settings

The **DAC Range Menu** provides access to the Analyzer's analog output range as well as its zero-scale and full-scale settings.

To display the **DAC Range Menu**:

- 1) With the Analog Setup Menu displayed, specify **DAC Range** and then press **Enter** to display its available menu selections.

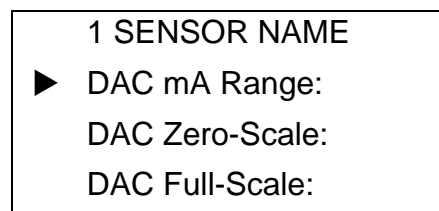

Fig 9-6 : DAC Range Menu

Analog Output Range

Default: 4 to 20 mA

The **DAC mA Range** internally defines the span (4 to 20 or 0 to 20 mA) of the analog output that is presented at the TOC600 Analyzer's 4–20 mA port. The lower and upper limits of the chosen range correspond to the **Zero-Scale** and **Full-Scale TOC** values.

To set the Analyzer's **mA Range**:

- 1) With the **DAC Range Menu** displayed, specify **DAC mA Range** and press **Enter** to display its parameters screen.

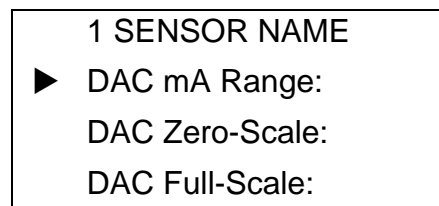

Fig 9-7 : DAC Range Menu

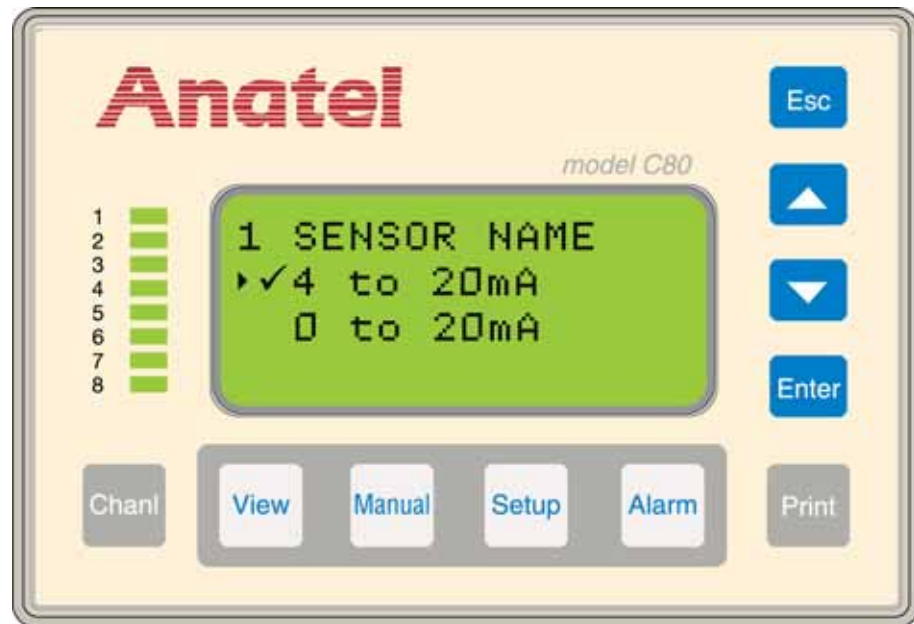

Fig 9-8 : mA Range Screen

- 2) Use the **Up** and **Down Keys** to select the desired analog output range.
- 3) Press **Enter** to enable the **DAC mA Range** selection.
- 4) Press **Esc** to return to the **DAC Range Menu**.

Note:

The chosen analog output range must match the range on the connected device for proper reporting.

TOC Output Range

Defaults: Zero-Scale: 0000 ppb, Full-Scale: 1000 ppb

These settings define the lower and upper ppb limits proportional to the **DAC mA Range** setting. The analog signal generated at the conclusion of each analysis is converted to a scaled TOC value for display and reporting purposes.

To set the TOC output range:

- 1) With the **DAC Range Menu** displayed, use the **Up** and **Down Keys** to specify **DAC Zero-Scale**.

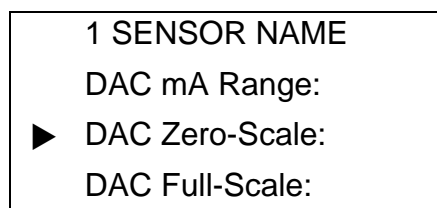

Fig 9-9 : DAC Range Menu

- 2) Press **Enter** to display its menu selections.
- 3) Specify **TOC DAC** and press **Enter** to display its zero-scale parameter screen. The flashing block cursor highlights the first pair of digits.

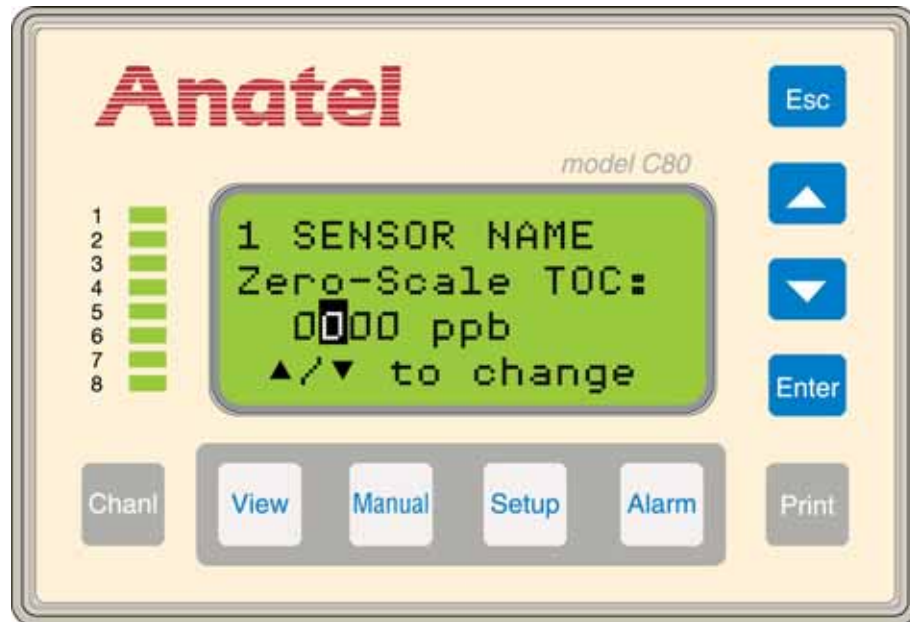

Fig 9-10 : Zero-Scale TOC Screen

- 4) Use the **Up** and **Down Keys** to specify the pair of digits to be changed.
- 5) Press **Enter** to enable the Controller's Edit Mode and the flashing block becomes an underscore.

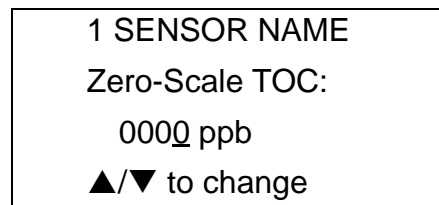

Fig 9-11 : Zero-Scale TOC Menu

- 6) Use the **Up** and **Down Keys** to scroll the pair until the desired value is displayed.
- 7) Press the **Esc Key** to retain the setting.
- 8) Repeat the editing process with the other pair of digits if necessary to display the desired value.

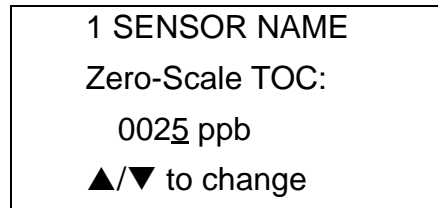

Fig 9-12 : Zero-Scale TOC Data

- 9) Press **Esc** twice to retain the **Zero-Scale TOC** setting and return to the **DAC Range Menu**.
- 10) Select **DAC Full-Scale** and press **Enter**.

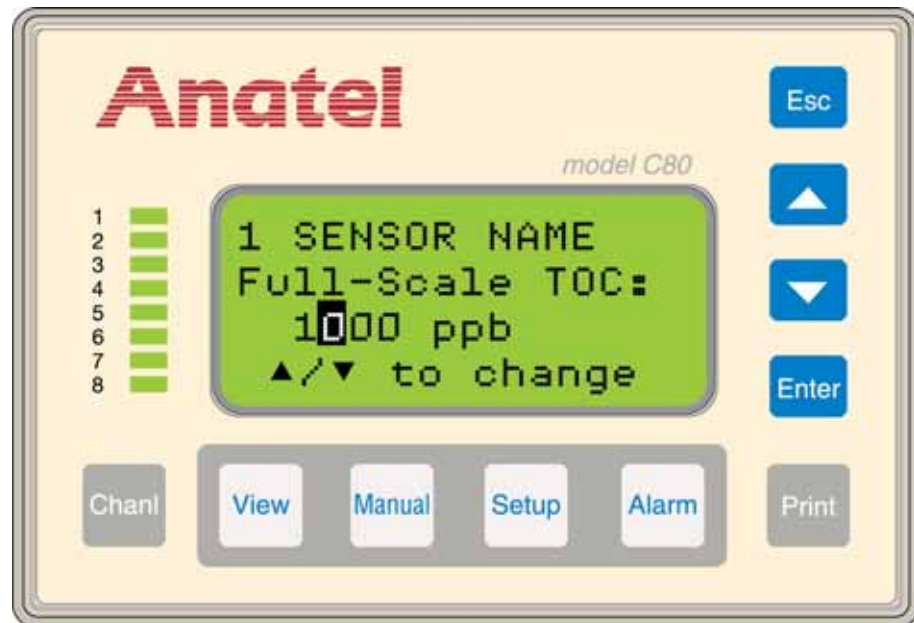

Fig 9-13 : Full-Scale TOC Screen

Note:

The **Full-Scale TOC** value must be greater than the **Zero-Scale TOC** value.

- 11) Specify **TOC DAC** once again and then press **Enter** to display its full-scale parameter screen. The flashing block cursor highlights the first pair of digits.
- 12) Use the same procedure as that described in [step 4](#) through [step 9](#) to specify the **Full-Scale TOC** value and return to the **DAC Range Menu**.

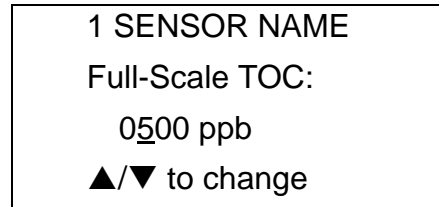

Fig 9-14 : Full-Scale TOC Data

DAC Error Output

Default: Minimum Output

The user may select from among three states to be output when a condition is encountered which causes the TOC600 Analyzer to abort its current analysis. This fixed signal is global for all analog outputs and can be used externally to report an alarm condition.

Note:

In the Calibrate mode, the analog output reflects online values. A zero-scale analog output indicates the instrument is off-line; a full-scale output indicates an error condition.

To specify the **DAC Error Output**:

- 1) With the Analyzer's **Analog Setup Menu** displayed, use the **Up** and **Down Keys** to specify **DAC Modes**.
- 2) Select **DAC Err Output** and press **Enter** to display its parameter screen.

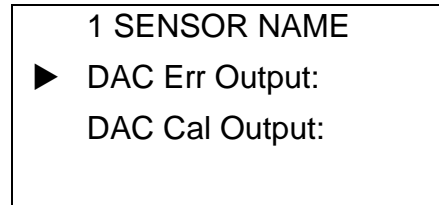

Fig 9-15 : DAC Error Output Menu

- 3) Use the **Up** and **Down Keys** to specify the desired setting:

Minimum Output	Transmits the Analyzer's corresponding Zero-Scale TOC value.
Last Output	Transmits the Analyzer's last reading.
Maximum Output	Transmits the Analyzer's corresponding Full-Scale TOC value.

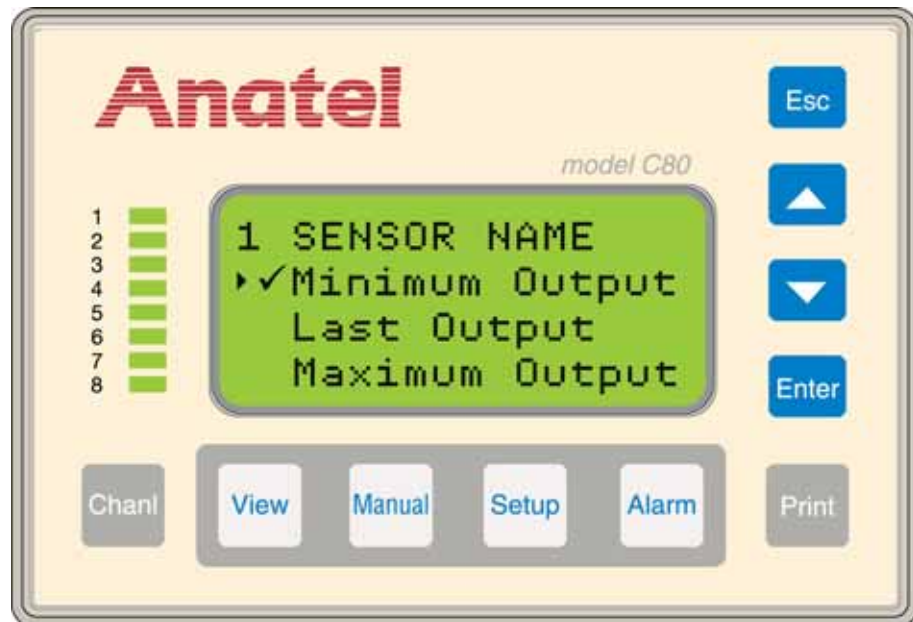

Fig 9-16 : DAC Error Output Screen

- 4) Press **Esc** to return to the **DAC Modes Menu**. Select **DAC Cal Output** to enable that feature, if desired. When "Active," an analog signal proportional to each analysis result is sent to an external DAC Module during calibration.
- 5) Press **Esc** repeatedly to exit this function and return to the normal display.

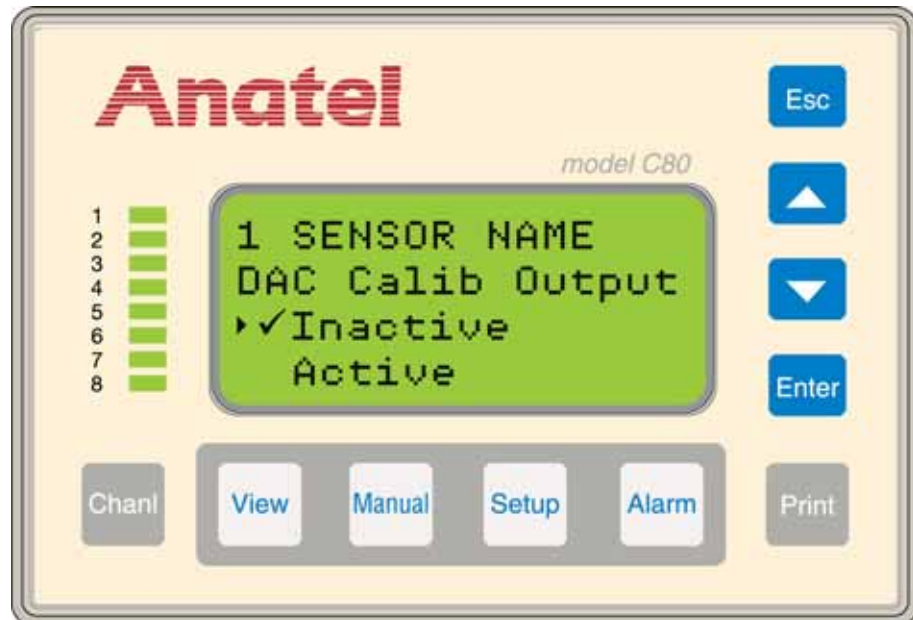

Fig 9-17 : DAC Calibration Output Screen

9.3 Optional Conductivity/Resistivity and Temperature Outputs

Resistivity DAC: P/N FG2006702, Temperature DAC: P/N FG2006802

The need for an analog output to report the TOC600 Analyzer's conductivity (or resistivity) and temperature values is addressed through external Digital-to-Analog Converter (DAC) Modules. A separate DAC Module is required for each desired analog output. Anatel supplies pre-programmed, prewired DAC Modules to forward this processed information to a data acquisition system, remote meter or other analog input device. Software setup of the External DAC Module includes enabling the Analyzer output, defining its range as well as its zero-scale and full-scale values, and the signal that is to be output in the event of an alarm.

9.3.1 Hardware Setup

Note:

Refer to the manufacturer's manual for complete instructions on installing and using external DAC Modules.

External DAC Modules are connected to the TOC600 Analyzer at its DIAGNOSTICS Port. This RS-232C serial interface communicates at 1200 baud, 8 data bits, 1 stop bit and no parity. Three- or five-conductor cable is adequate for this analog interface (AWG 24 is recommended). Two DAC Modules can be daisy-chained to obtain both conductivity (or resistivity) and temperature data and can be positioned up to 50 feet from the associated Analyzer. Anatel provides five feet of cabling.



WARNING

To avoid electrical shock, always disconnect the instrument from its power source before attempting to access internal components.

These auxiliary analog connections are made on the Analyzer's I/O Connector Block as follows:

- 1) Turn the TOC600 Analyzer Analyzer **OFF** and disconnect the power cord from its source.
- 2) Remove the I/O Connector Block from the bottom of the Analyzer by loosening its four screws.
- 3) Loosen and remove the two screws that secure the metal strain relief plate.
- 4) Feed the Module wiring through one of the five holes at the end of the Connector Block cover and along the corresponding slot in the foam padding.
- 5) Make the necessary connections to the Analyzer's DIAGNOSTICS port as shown.

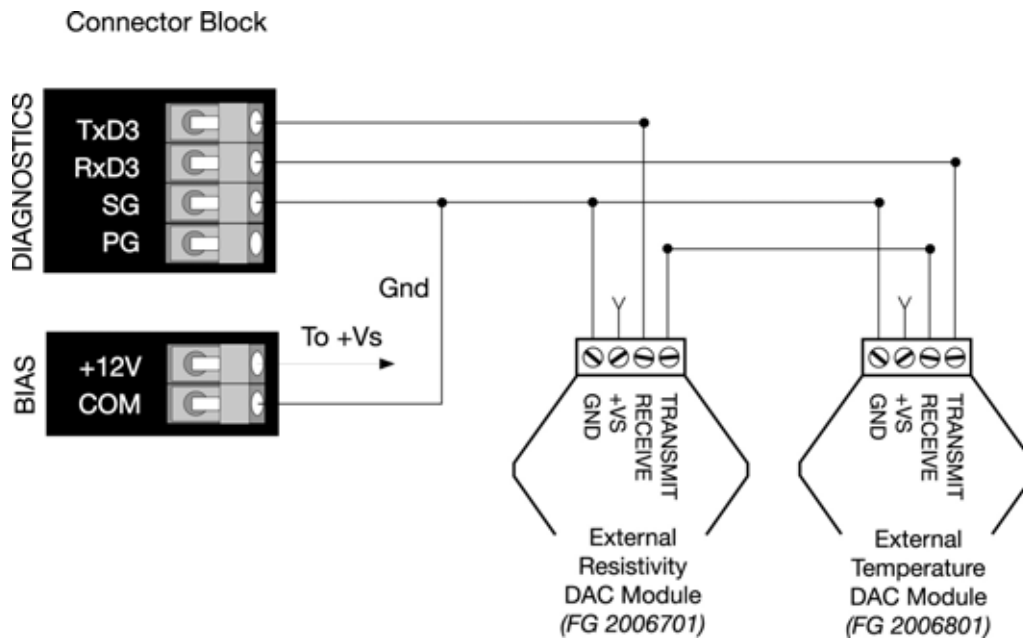

Fig 9-18 : External DAC Wiring

- 6) Replace the metal strain relief plate.
- 7) Replace the I/O Connector Block on the bottom of the Analyzer, taking care not to pinch any wires, and secure it in place by tightening the screws.
- 8) Reconnect the power cord and turn the Sensor **ON**.

9.3.2 Software Setup

The output signal generated at the conclusion of an analysis cycle is calculated based on the sample's reading and represents either conductivity (in $\mu\text{S}/\text{cm}$), resistivity (in $\text{M}\Omega\text{-cm}$) or temperature (in $^{\circ}\text{C}$). The transmitted signal remains constant until the next analysis cycle is complete. If a critical alarm is encountered during an analysis, the external analog output goes to a pre-defined output state.

Setting the External DAC output consists of:

- 1) Enabling the Analyzer's DAC output.
- 2) Specifying the analog output range.
- 3) Defining the associated zero-scale and full-scale values that establish the resolution of that signal.
- 4) Establishing the signal that is to be output in the event of an TOC600 Analyzer alarm.

External DAC Module

Default: No

This software switch enables and disables the conductivity (or resistivity) and temperature output to an External DAC Module. The Module then converts the output into an analog signal

for processing by a variety of devices. This signal also reflects the **DAC Error Output** (see [“DAC Error Output” on page 126](#)) in the event of an TOC600 Analyzer alarm.

To enable/disable the **External DAC Module** interface:

- 1) With the desired Analyzer selected in any View, press the **Setup Key** to display its menu.

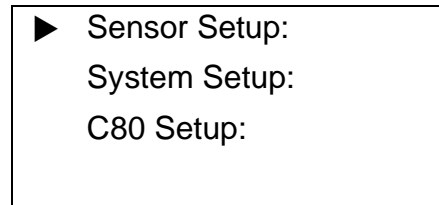

Fig 9-19 : Setup Menu

- 2) Use the **Up** and **Down Keys** to specify **Sensor Setup**.
- 3) Press **Enter** to display the **Sensor Setup Menu**.
- 4) Specify **Analysis Setup** and press **Enter**.
- 5) Specify **Analog Setup** and press **Enter** to access its parameter options.
- 6) With the **Analog Setup Menu** displayed, specify **Ext DAC Module**.

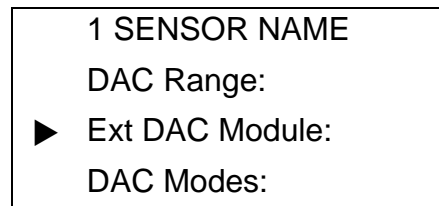

Fig 9-20 : DAC Error Output Menu

- 7) Press **Enter** to view its parameter screen.
- 8) Use the **Up** and **Down Keys** to toggle the software switch to **Yes** to enable this analog output, **No** disables it.

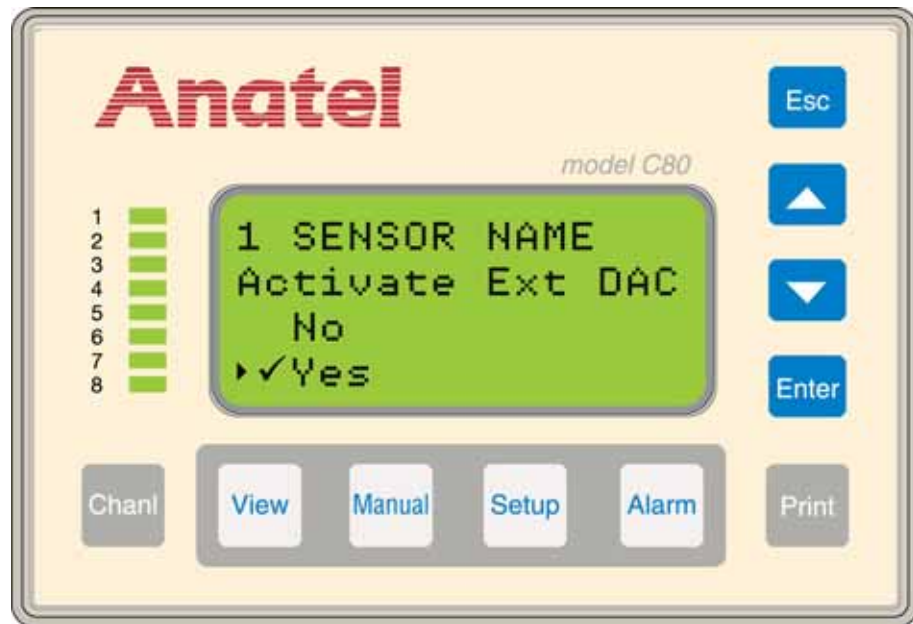

Fig 9-21 : External DAC Module Screen

Note:

On activation of the External DAC Module, an Error Code #17: “Bad DAC Module” indicates that there is a communications problem.

- 9) Press **Enter** to save the **Ext DAC Module** setting.
- 10) Press **Esc** to return to the **Analog Setup Menu**.

Analog Output Range

Default: 4 to 20 mA
 Optional: 0 to 20 mA

The **DAC mA Range** internally defines the span (**4 to 20** or **0 to 20 mA**) of the analog output that is presented at the TOC600 Analyzer’s digital-to-analog (DAC) port. Note that this setting is global for all analog outputs including the external DAC modules as well as the internal DAC. The lower and upper limits of the chosen range correspond to the **Zero-Scale** and **Full-Scale Conductivity/Resistivity** or **Temperature** values, depending on the output.

To set the Analyzer’s **DAC mA Range**:

- 1) With the **Analog Setup Menu** displayed, select **DAC Range** to display its menu selections.

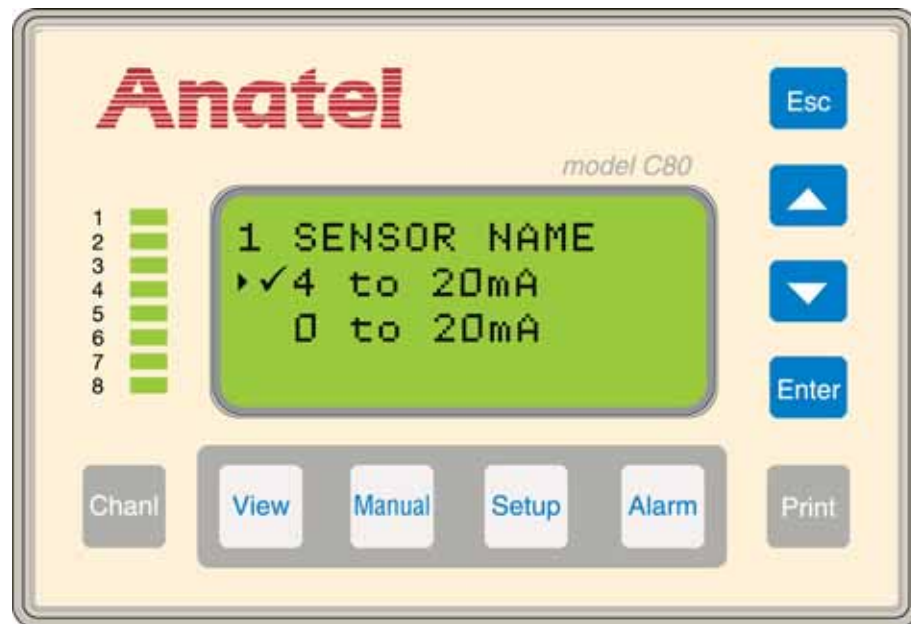

Fig 9-22 : DAC mA Range Screen

- Specify **DAC mA Range** and press **Enter** to display its parameter screen.

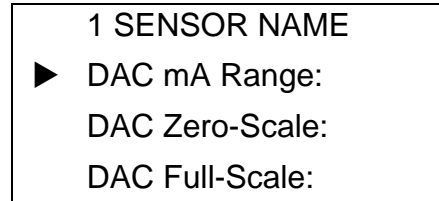

Fig 9-23 : DAC mA Range Menu

- Use the **Up** and **Down Keys** to specify the desired analog output range.

Note:

The chosen analog output range must match the range of the connected device for proper communication.

- Press **Enter** to enable the **DAC mA Range** selection.
- Press **Esc** to return to the **DAC Range Menu**.

Conductivity/ Resistivity Output

Defaults: Zero-Scale: 00 μ S/cm, Full-Scale: 20 μ S/cm

The **DAC Zero-Scale** and **Full-Scale** settings define the upper and lower limits that are proportional to the **DAC mA Range** setting. The analog signal is converted to a scaled conductivity or resistivity value for output, depending on the selected **Display Units** setting (see “[Display Units](#)” on page 54).

To set the output range:

- 1) With the **DAC Range Menu** displayed, use the **Up** and **Down Keys** to specify **DAC Zero-Scale**.

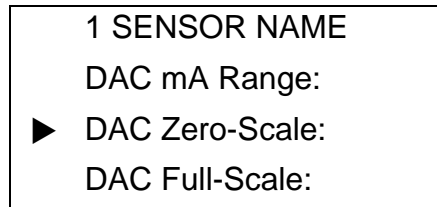

Fig 9-24 : DAC Zero-Scale Menu

- 2) Press **Enter** to display its menu selections.
- 3) Specify **Res/Cond DAC** and press **Enter** to display its zero-scale parameter screen. The units reflect the **Resis/Cond** parameter selection, displayed in **uS/cm** for conductivity or **MΩ-cm** for resistivity. If either unit is followed by a **U**, it indicates that the reading is uncompensated.

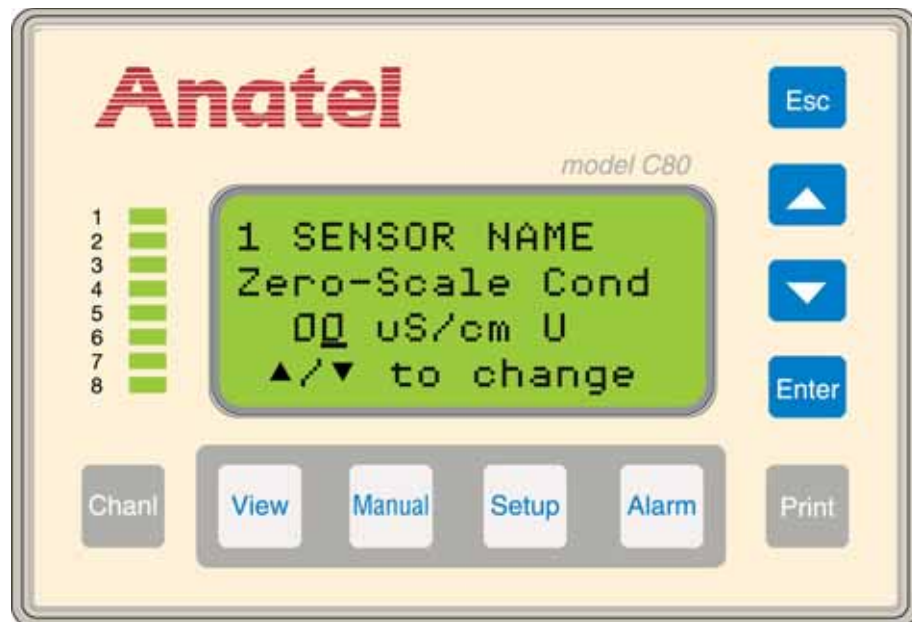

Fig 9-25 : Zero-Scale Uncompensated Conductivity Display

- 4) Use the **Up** and **Down Keys** to scroll in single increments until the desired value is displayed.

```

1 SENSOR NAME
Zero-Scale Cond
 01 uS/cm U
▲/▼ to change

```

Fig 9-26 : Zero-Scale TOC Data

- 5) Press **Esc** twice to retain the **Zero-Scale Cond** setting and return to the **DAC Range Menu**.
- 6) Select **DAC Full-Scale** and press **Enter**.

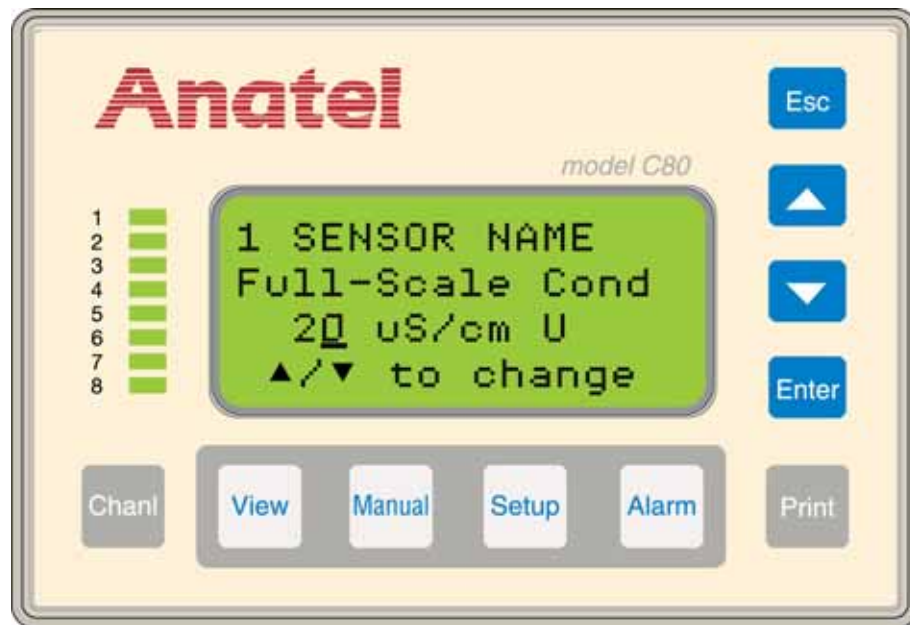

Fig 9-27 : Full-Scale Uncompensated Conductivity Display

Note:

The **Full-Scale Cond** value must be greater than the **Zero-Scale Cond** value.

- 7) Specify **Res/Cond DAC** and press **Enter** to display its full-scale parameter screen.
- 8) Use the **Up** and **Down Keys** to scroll the setting until the desired value is displayed.

```

1 SENSOR NAME
Full-Scale Cond
 15 uS/cm U
▲/▼ to change

```

Fig 9-28 : Full-Scale TOC Data

- 9) Press **Esc** twice to retain the **Full-Scale Res/Cond** setting and return to the **DAC Range Menu**.

Temperature Output

Defaults: Zero-Scale: 5 °C, Full-Scale: 95 °C

The **DAC Temp** setting defines the upper and lower limits that are proportional to the **DAC mA Range** setting. The analog signal is converted to a scaled temperature value for output.

To set the temperature output range:

- 1) With the **DAC Range Menu** displayed, use the **Up** and **Down Keys** to specify **DAC Zero-Scale**.

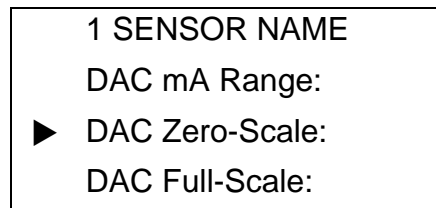

Fig 9-29 : DAC Zero-Scale Menu

- 2) Press **Enter** to display its menu selections.
- 3) Specify **Temp DAC** and press **Enter** to display its zero-scale parameter screen.

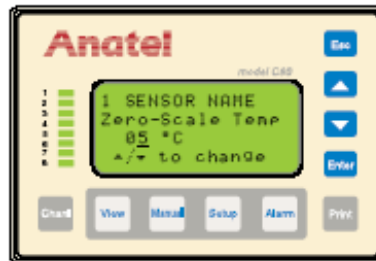

Fig 9-30 : Zero-Scale Temperature Screen

- 4) Use the **Up** and **Down Keys** to scroll in one degree increments until the desired value is displayed.

Note:

The Full-Scale Temp value must be greater than the Zero-Scale Temp value.

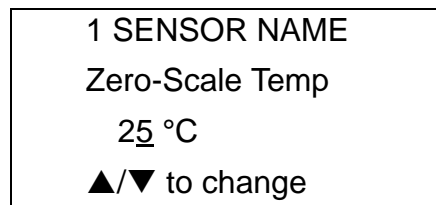

Fig 9-31 : Zero-Scale Temp Data

- 5) Press **Esc** twice to retain the **Zero-Scale Temp** setting and return to the **DAC Range Menu**.
- 6) Select **DAC Full-Scale** and press **Enter**.

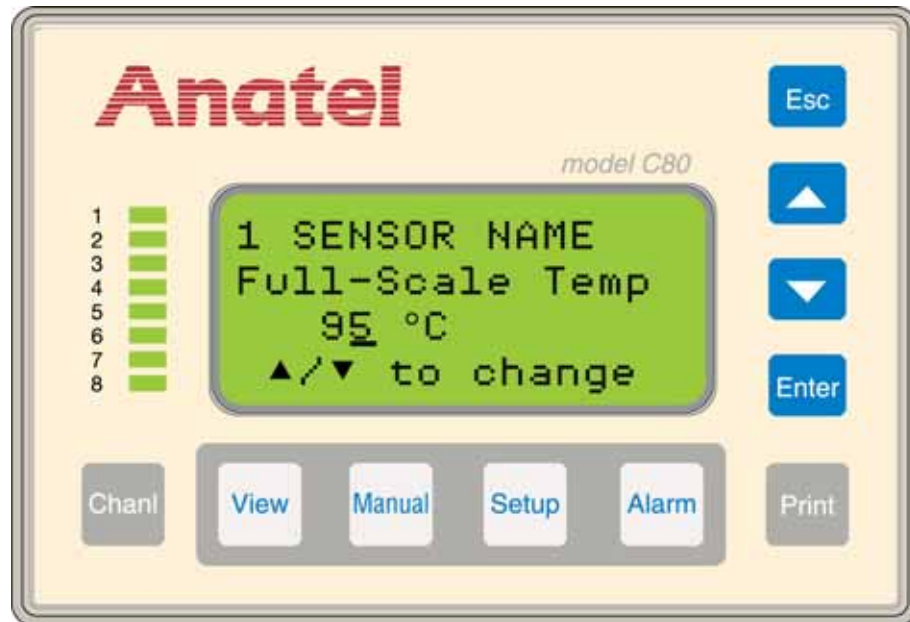

Fig 9-32 : Full-Scale Temperature Screen

Note:

The **Full-Scale Temp** value must be greater than the **Zero-Scale Temp** value.

- 7) Specify **Temp DAC** and press **Enter** to display its full-scale parameter screen.
- 8) Use the **Up** and **Down Keys** to scroll the setting until the desired value is displayed.

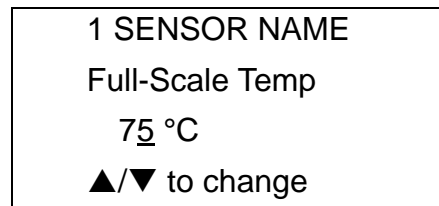

Fig 9-33 : Full-Scale Temp Data

- 9) Press **Esc** twice to retain the **Full-Scale Temp** setting and return to the **DAC Range Menu**.

10 Digital Inputs and Outputs

10.1 General Information

The TOC600 Analyzer's I/O Connector Block is equipped with two opto-isolated inputs and two opto-isolated outputs for receiving and sending digital signals. The digital inputs allow limited supervisory control of the Analyzer by a remote device or switch. A pair of digital outputs also is provided for connection to such compatible devices as a remote alarm indicator or a Programmable Logic Controller (PLC).



WARNING

To avoid electrical shock, always disconnect the instrument from its power source before attempting to access internal components.

CAUTION:

*The TOC600 Analyzer digital outputs **ARE NOT** designed for process control functions such as pump On/Off switching or water system shutdown. These connections are not intended to act as, or replace, a PLC.*

Digital input and output connections are made on the instrument's I/O Connector Block as follows:

- 1) Turn the TOC600 Analyzer **OFF** and disconnect the power cord from its source.
- 2) Remove the I/O Connector Block from the bottom of the Analyzer by loosening its four screws.
- 3) Loosen and remove the two screws that secure the metal strain relief plate.
- 4) Feed the interface wiring through one of the five holes at the end of the Connector Block cover and along the corresponding slot in the foam padding.
- 5) Make the necessary connections to the appropriate DIGITAL terminals (see below).

Note:

Observe the correct polarity when making any digital input and output connections to the Analyzer.

- 6) Replace the metal strain relief plate.
- 7) Replace the I/O Connector Block on the bottom of the Analyzer, taking care not to pinch any wires, and secure it by tightening the screws.

CAUTION:

The I/O Connector Block must be reinstalled correctly to conform to emissions specifications.

- 8) Reconnect power and turn the Analyzer **ON**.

10.2 Digital Inputs

Both of the digital inputs perform specific TOC600 Analyzer functions, allowing total control over its operation as well as synchronization with the rest of the process. The first set of inputs is used to initiate an analysis from an external device. The analysis is based on the instrument's

specified **Sample Time** and **Cycle Time** settings. The second input dictates the instrument's operational mode as either Auto TOC or Purge. Both inputs also require that the Analyzer be placed under **Digital Control**.

10.2.1 Hardware Setup

The two digital inputs share a common positive terminal. They are driven by a 5 to 30 VDC external power source or the Analyzer's 12 VDC, 0.5 Amp Bias and designed to operate from open collector, open drain or relay outputs. Each input draws between 1 and 14 mA, depending on the applied voltage. The hardware connections are established as described in "[General Information](#)" on page 137; the Inputs terminals have the following designations and functions:

- IN1* Allows external initiation of an analysis. When Input #2 selects the Auto TOC Mode, a high-to-low state transition forces the instrument to initiate an analysis cycle.
- IN2* Selects between the Auto TOC (high state) and the Purge (low state) Mode. State transitions are ignored on IN1* when the instrument is in the Purge Mode.

Table 10-1 : Digital Inputs

IN1*	IN2*	Mode
N/A	High	Auto TOC
N/A	Low	Purge
H→L†	High	Begin Analysis
†Min 0.1 second pulse duration		

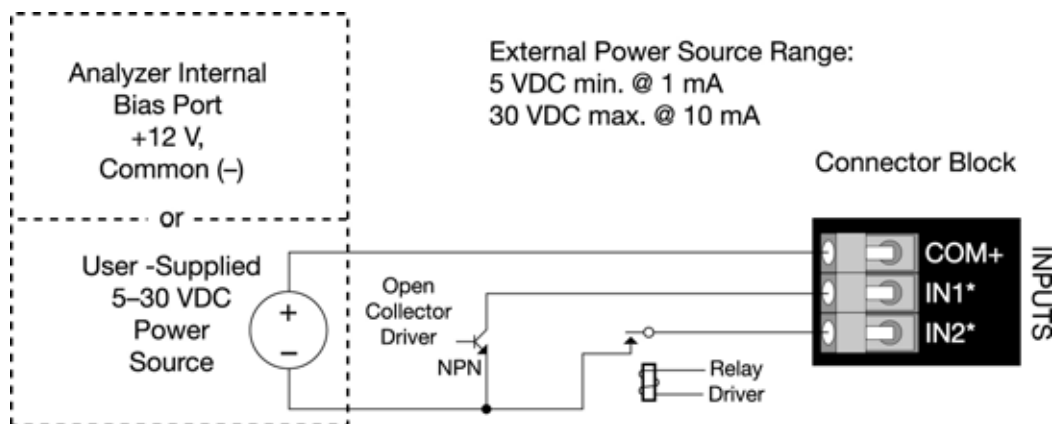

Fig 10-1 : Typical Digital Input Wiring

10.2.2 Software Setup

The **Digital Control** parameter must be enabled for the TOC600 Analyzer to accept any digital input signals. This software switch is accessed through the **Manual Key** and, once enabled,

displays **r/c** in conjunction with the Analyzer's displayed TOC readings to indicate that the instrument is operating under remote control.

To enable external **Digital Control**:

- 1) With the desired Analyzer selected in any View, press the **Manual Key** to display its submenu.

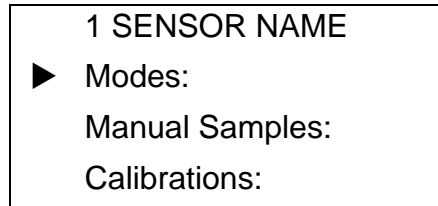

Fig 10-2 : Manual Submenu

- 2) Use the **Up** and **Down Keys** to specify **Modes**.
- 3) Press **Enter** to display the **Modes Menu**.

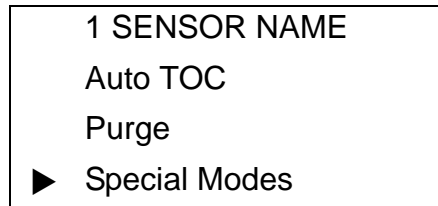

Fig 10-3 : Modes Menu

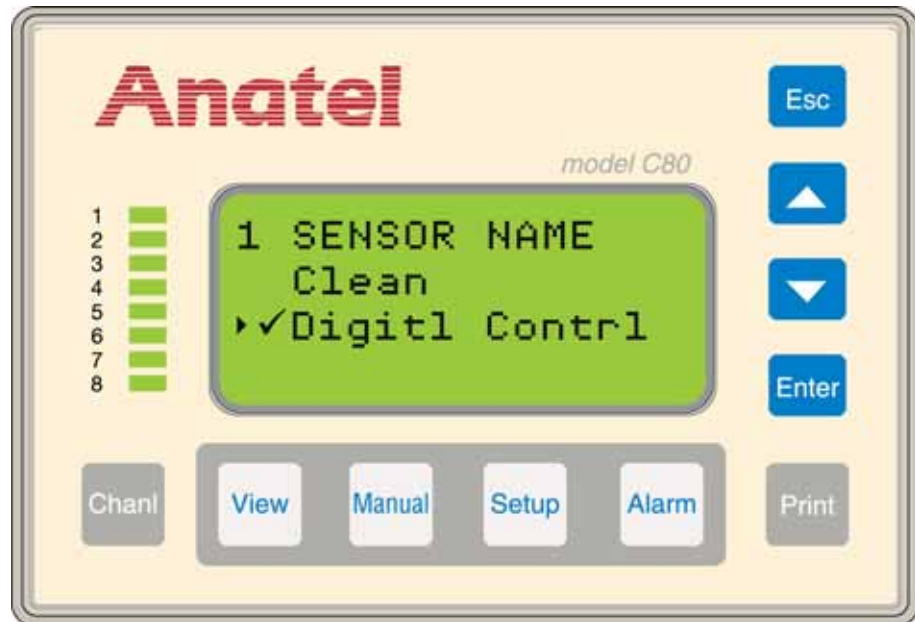

Fig 10-4 : Special Modes Screen

- 4) Specify **Special Modes** and press **Enter** to display its operational options.
- 5) Use the **Up** and **Down Keys** to indicate **Digitl Control**.
- 6) Press **Enter** to enable external digital control of the Analyzer. Activating this mode inserts **r/c** anywhere the instrument's TOC status is displayed to indicate that it is under remote control.
- 7) Press **Esc** repeatedly to exit this function and return to the normal display.

10.3 Digital Outputs

The digital outputs also transmit specific TOC600 Analyzer information. The first digital output reports the instrument's current TOC alarm status and can be used to trigger an alarm indication or similar response. The second digital output reports the state of the Analyzer's internal sample valve or, if alternatively configured, the uncompensated conductivity alarm status (see ["Uncompensated Conductivity Alarms" on page 102](#)).

10.3.1 Hardware Setup

Both digital outputs are 8.5 mA current sinks which share a common negative terminal. They are designed to drive solid state relay inputs and have a compliance range from 5 to 30 VDC. The hardware connections are established as described in ["General Information" on page 137](#); the OUTPUTS terminals carry the following designations and functions:

- OUT1* Reports the instrument's TOC level as above (low state) or below (high state) the user-specified Alarm Limit.
- OUT2* Reports the state of the instrument's sample valve as open (high state) or closed (low state). Alternatively, if temperature uncompensated conductivity alarm is enabled, the output is based on the USP uncompensated conductivity alarm table (see ["Uncompensated Conductivity Alarms" on page 102](#)).

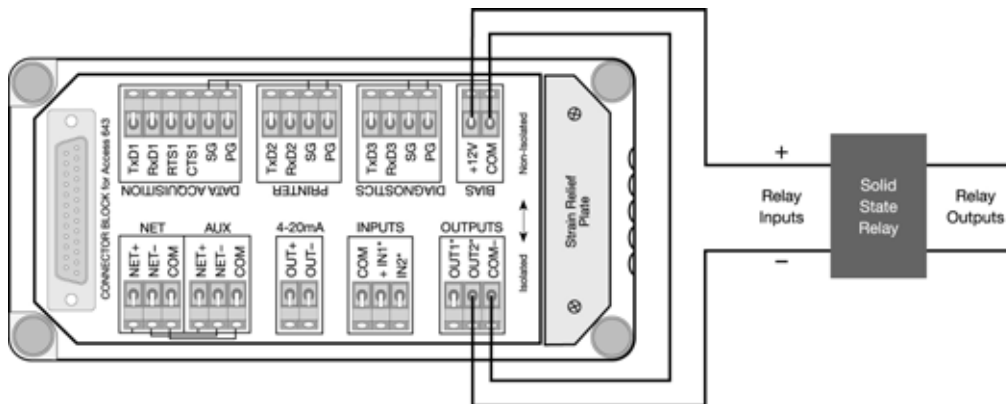

Fig 10-5 : Typical Digital Output Wiring

11 12 VDC Bias Output

11.1 General Information

TOC600 Analyzer Analyzers are equipped with a connection that can supply power for such auxiliary devices as the External DAC Modules to obtain conductivity (or resistivity) and temperature data from TOC600 Analyzer.

11.2 Hardware Setup

The BIAS Port furnishes 12 VDC, 1/2 Amp power from the Analyzer's supply. The port is non-isolated and therefore discretion should be used when attaching an external device.



WARNING

To avoid electrical shock, always disconnect the instrument from its power source before attempting to access internal components.

Bias connections are made to the instrument's I/O Connector Block as follows:

- 1) Turn the TOC600 Analyzer **OFF** and disconnect the power cord from its source.
- 2) Remove the I/O Connector Block from the bottom of the Analyzer by loosening its four screws.

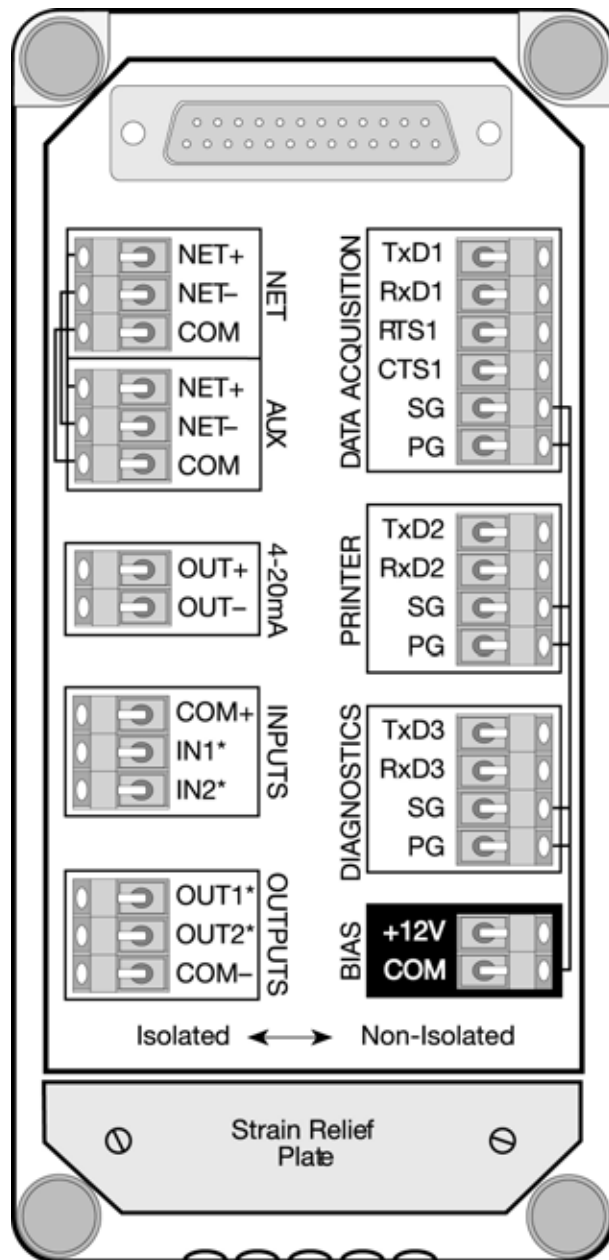

Fig 11-1 : Bias Connections

- 3) Loosen and remove the two screws that secure the metal strain relief plate.
- 4) Feed the interface wiring through one of the five holes at the end of the Connector Block cover and along the corresponding slot in the foam padding.
- 5) Make the necessary positive and ground connections to the Analyzer's BIAS terminals.
- 6) Replace the metal strain relief plate.
- 7) Replace the I/O Connector Block on the bottom of the Analyzer, taking care not to pinch any wires, and secure it by tightening the screws.

CAUTION:

The I/O Connector Block must be reinstalled correctly to conform to emissions specifications.

- 8) Reconnect power and turn the Analyzer **ON**.

CAUTION:

Drawing more than the available power may cause erratic behavior, loss of data, instrument shutdown, and/or component damage.

12 Serial Communications

12.1 General Information

TOC600 Analyzers are equipped with a bidirectional serial interface that allows them to communicate with a wide variety of intelligent devices such as a Programmable Logic Controller (PLC) or a host computer. The wiring is configured as for any PC-compatible RS-232C serial interface.

12.2 Hardware Setup

Serial connections are made to the Analyzer on its DATA ACQUISITION Port. This RS-232C connection communicates at 1200 baud, 8 data bits, 1 stop bit and no parity. Three- or five-conductor cable is adequate for most serial interfaces (AWG 24 is recommended), depending on the connected device.



WARNING

To avoid electrical shock, always disconnect the instrument from its power source before attempting to access internal components.

Interface connections are made on the instrument's I/O Connector Block as follows:

- 1) Turn the TOC600 Analyzer Analyzer **OFF** and disconnect the power cord from its source.
- 2) Remove the I/O Connector Block from the bottom of the Analyzer by loosening its four screws.
- 3) Loosen and remove the two screws that secure the metal strain relief plate.
- 4) Feed the interface wiring through one of the five holes at the end of the Connector Block cover and along the corresponding slot in the foam padding.

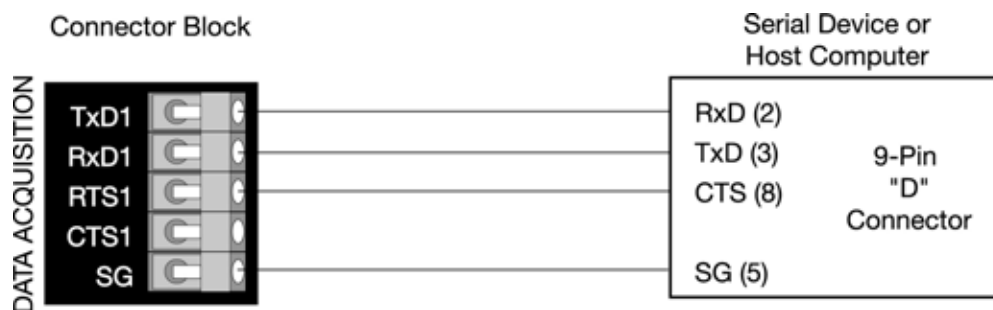

Fig 12-1 : Serial Wiring

- 5) Make the necessary connections to the Analyzer's DATA ACQUISITION Port Terminals as shown in [Figure 12-1](#).
- 6) Replace the metal strain relief plate.

- 7) Replace the I/O Connector Block on the bottom of the Analyzer, taking care not to pinch any wires, and secure it by tightening the screws.
- 8) Reconnect power and turn the Analyzer ON.

Note:

The I/O Connector Block must be reinstalled correctly to conform to emissions specifications.

12.3 TOC600 Analyzer Command Set

Serial interface commands consist of Mode Set, Parameter Set, Data Read, Data Logger and Data History functions. The commands consist of two character ASCII text. Some commands also require one or more arguments, each delimited by at least one space (ASCII 32; 20 Hex), followed by the command mnemonic text. Each command string is terminated with a carriage return (ASCII 13; 0D Hex).

Note:

TOC600 Analyzers respond to either uppercase or lowercase commands.

The TOC600 Analyzer will respond with an "OK>" prompt after the command has been accepted. In addition, Data Read and Parameter Set commands elicit a reply that consists of one or more numeric or text values, each delimited by at least one space, and terminated by a carriage return, line-feed pair (ASCII 13,10; 0D,0A Hex).

Both commands and replies use a "free field" format, so the number of delimiting spaces and length of each argument or data field may vary. If a command is rejected due to invalid syntax, for instance, refusal is indicated by a question mark (ASCII 63; 3F Hex) reply preceding the "OK>" prompt.

The notations used to represent command arguments below are shown in [Table 12-1](#).

Table 12-1 : Notations for Command Arguments

Notation	Command Argument
hh:mm:ss	hours:minutes:seconds
n	decimal number (e.g., "1.234")
i	integer (e.g., "1")
s	text string (e.g., "SENSOR_NAME")
b	binary flag ("1" or "0")

12.3.1 Mode Set Commands

The Mode Set commands are used to determine the instrument's operational mode.

Table 12-2 : Mode Set Commands

Command	Function	Comment
MC	Self-Clean Mode	Valve open, lamp on.
MD	Auto TOC Mode	Continuous TOC analyses.

Table 12-2 : Mode Set Commands

Command	Function	Comment
ME	Clear Code Log	Erases Codes from memory.
MO i	Start TOC Analysis	One or more TOC analyses, then goes to Idle State. The default is one analysis cycle if an argument ("i") is not specified.
MP	Purge Mode	Valve open, lamp off, shows resistivity/conductivity and temperature.
MZ	Idle State	Places the Analyzer in the Idle State (if present).

12.3.2 Parameter Set Commands

Issuance of the "HR" command displays or sets the user-defined TOC600 Analyzer parameters. When issued without arguments, the Analyzer's current settings are displayed; issued with arguments, the specified parameters are changed for the Analyzer and a printout is generated documenting the modification. If an "out of bounds" value is sent, the entire command is ignored.

Note:

Issuing the "HR" command without specifying arguments displays the current parameter settings.

"Read-Only" values cannot be modified.

Table 12-3 : Parameter Set Commands

Command	Function	Section
HR t t i i...	Sample Time (hh:mm:ss)	"Sample Time" on page 61
	Cycle Time (hh:mm:ss)	"Cycle Time" on page 64
	Absolute TOC Alarm Limit (ppb)	"Alarm Setup" on page 97
	Reserved (always "0")	
	Analyzer Channel ID # (1-8)	"Controller Address" on page 37
	Analyzer Name (1-13 characters)	"Analyzer Name" on page 20
	Cycle Modes (0 = TOC & Idle, 1 - TOC & Purge)	"Cycle Modes" on page 66
	Sampling Mode (0 = Water Saver, 1 = Continuous)	"Sampling Mode" on page 65
	Diagnostic Port Function (0 = normal, 1 = External DAC Module)	"External DAC Module" on page 129
	Conductivity/Resistivity Units of Measure <ul style="list-style-type: none"> • 0 = MΩ-cm • 1 = μS/cm • 2 = MΩ-cm uncompensated • 3 = μS/cm uncompensated 	"Factory Defaults" on page 49
	20 mA Output during TOC Calibration (0 = inactive, 1 = active)	"DAC Error Output" on page 126

Table 12-3 : Parameter Set Commands (Continued)

Command	Function	Section
	TOC Mode Print Strategy <ul style="list-style-type: none"> • 0 = Continuous • 1 = Paper Saver 	"Auto TOC Mode Printout" on page 68
	Purge Mode Print Strategy <ul style="list-style-type: none"> • 0 = Continuous • 1 = Paper Saver 	"Purge Mode Printouts" on page 71
	Active Alarm Type <ul style="list-style-type: none"> • 0 = absolute ppb • 2 = absolute ppb and uncompensated conductivity alarm 	"Uncompensated Conductivity Alarms" on page 102
	Analog Output Type <ul style="list-style-type: none"> • 0 = 4 to 20 mA • 1 = 0 to 20 mA 	"Analog Output Range" on page 122
	20mA Output On Alarm <ul style="list-style-type: none"> • 0 = minimum value • 1 = unchanged • 2 = maximum value 	"DAC Error Output" on page 126
	TOC Mode Paper Saver Percentage Change (1-99)	"Auto TOC Mode Printout" on page 68
	Purge Mode Paper Saver Percentage Change (1-99)	"Purge Mode Printouts" on page 71
	Purge Mode Interval Between Printouts (hh:mm:ss)	"Purge Mode Printouts" on page 71
	Zero-Scale TOC Range (ppb)	"TOC Output Range" on page 123
	Full-Scale TOC Range (ppb)	"TOC Output Range" on page 123
	User TOC Calibration Slope (<i>Read-Only</i>)	
	External DAC Zero-Scale Conductivity/Resistivity Range (Units depend on <i>Conductivity/Resistivity Units of Measure</i>)	"Conductivity/ Resistivity Output" on page 132
	External DAC Zero-Scale Temperature Range (°C)	"Temperature Output" on page 135
	External DAC Full-Scale Temperature Range (°C)	"Temperature Output" on page 135
	Digital Control <ul style="list-style-type: none"> • 0 = disabled • 1 = enabled 	"Digital Inputs" on page 137
	Log <ul style="list-style-type: none"> • 0 = Data & Audit • 1 = Audit Only 	"Internal Log" on page 111
	User Conductivity Calibration Slope (<i>Read-Only</i>)	

Table 12-3 : Parameter Set Commands (Continued)

Command	Function	Section
	<i>Example:</i> "HR 00:01:00 00:00:00 500 0 0 1 SENSOR_NAME 0 0 0 0 0 0 0 0 0 1 1 00:01:00 0 1000 1.0 0 20 5 95 0 1.0 <cr>"	
SY	Set Time (MM:DD:YY:hh:mm:ss format)	"System Time" on page 18
	<i>Example:</i> "SY 03 04 1993 12 33 00 <cr>"	

12.3.3 Data Read Commands

The Data Read functions return multiple values, the string terminated with a <cr><lf>.

If the TOC600 Analyzer is in an operational mode that does not generate a TOC result (modes 6 through 12), the TOC, TOC Alarm Percentage, TOC Trend, Profile (Curve) Type and Oxidation Time are not returned.

Data normally is returned only in response to issuance of the RD or RE commands. When collecting data with a serial communications program such as Hyperterminal®, it is more convenient to have the data displayed automatically. This can be done using the SA command, which then displays data whenever they are reported.

Table 12-4 : Data Read Commands

Command	Function	Comment
RD	Read Analyzer Data	<p>Returns one line of time stamped data from when the unit began oxidation: mm/dd/yyyy, hh:mm, mode, state, TOC in ppb, alarm percentage, trend in ppb/hr, resistivity in MΩ-cm, temperature in °C, curve (profile) type and oxidation time in seconds.</p> <p>The mode is: 1 = Auto TOC 2 = Single TOC 3 = Digital TOC 4 = Sample Manual 5 = Manual Manual 6 = Clean Mode 7 = Purge Mode 8 = Digital Purge 9 = Temperature Test 10 = Self-Calibrate 11 = Idle Mode 12 = Failure Mode</p> <p>The state is: 1 = Idle 2 = Sample 3 = Oxidize 4 = Self-Calibrate 5 = Repurge</p>

Table 12-4 : Data Read Commands

Command	Function	Comment
RE	Read Analyzer Codes	Returns time stamped alarms, if any, since the last power-up or ME command issued, one Code per line: hh:mm:ss (time of first occurrence), alarm code, number of occurrences and alarm description.

12.3.4 Log Commands

Log functions return information on the instrument's internal Log.

Table 12-5 : Log Commands

Command	Function	Notes
LP	Display Log	Displays the contents of the internal Log. If any third character is appended to the command (i.e., "LPx"), the display is aborted.
LU	Report Log Usage	Displays what percentage (0 to 100) of the internal Log has been used.

12.3.5 Data History Commands

The Data History commands return the results of the most recent calibration and validation procedures performed on the instrument.

Table 12-6 : Data History Command

Command	Function	Notes
PC	Conductivity Calibration History	Up to five calibrations are displayed.
PT	TOC Calibration History	Up to five calibrations are displayed.
PS	System Suitability Calibration History	Up to five tests are displayed.
PV	TOC Validation History	Up to five tests are displayed.

13 TOC600 Analyzer Maintenance

13.1 General Information



WARNING

Many of these procedures may expose the operator to electrical shock if power is not removed before beginning the procedure. None of these procedures should be attempted by untrained personnel.



WARNING

Service personnel should read and understand all safety precautions in [“General Safety Considerations” on page 7](#) and [“TOC600 Analyzer Warnings and Cautions” on page 8](#) before attempting any service procedure. Service personnel should be familiar with safety practices for electrical hazards and electrostatic discharge (ESD).

Anatel TOC600 Analyzers require periodic maintenance in order to ensure the continued accuracy and reliable performance of the instrument. The UV lamp has a limited life and should be replaced every six months. It is recommended that the measurement cell have an annual calibration verification.

Maintenance procedures may be performed either by the user or by Hach Ultra Customer Service Personnel. The most common maintenance procedures are:

- UV lamp replacement
- Air filter cleaning
- Printer maintenance

In most instances, the user can perform these procedures in the field. If problems persist after performing maintenance or repair procedures, contact the Hach Ultra Customer Service Department at 800.866.7889 or 541.472.6500. Should it be necessary to return equipment to the factory for maintenance or repair, refer to [“Return Procedures” on page 179](#).

CAUTION:

Purge all water from the Analyzer when taking the instrument out of service. Residual water can freeze inside the unit, expand and damage the measurement cell. Such damage is time-consuming to repair and is not covered by the warranty.

Hach Ultra also offers service and extended warranty options to cover scheduled maintenance, calibration and repairs. In cases where returning the Analyzer to the factory is impractical, on-site maintenance and/or verification can be performed by a Hach Ultra technician, or a certified instrument may be rented. Repairs are performed only at Hach Ultra Service Centers due to the specialized equipment and parts required.

13.2 Enclosure Cleaning

If cleaning equipment is required, the instrument enclosure can be cleaned using a mild detergent and water-dampened cloth.

CAUTION:

Do not use abrasive cleaners as they can scratch the instrument's painted finish. Do not subject the enclosure to a direct spray as it could damage internal components.

13.3 Self-Cleaning Mode

It is possible to contaminate an TOC600 Analyzer's measurement cell on any water system or after long-term storage or inactivity. This condition is indicated by suddenly changing or erratic TOC or resistivity readings. Extended self-cleaning using the ultraviolet lamp to oxidize contaminants in the cell is the recommended procedure to alleviate such problems. In the Self-Clean Mode, the Analyzer's sample valve is opened to allow water to flow through the cell. The UV lamp is turned on to oxidize any organic contaminants, which subsequently are flushed from the instrument.

To place an TOC600 Analyzer in the Self-Clean Mode:

- 1) With the desired Analyzer selected in any View, press the **Manual Key** to display its menu.

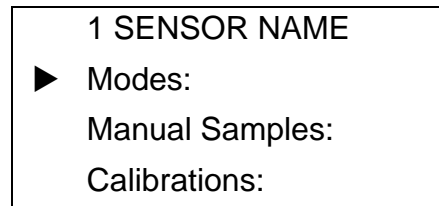

Fig 13-1 : Manual Menu

- 2) Use the **Up** and **Down Keys** to specify **Modes**.
- 3) Press **Enter** to display its submenu.
- 4) Specify **Special Modes** from among the available options and press **Enter**.

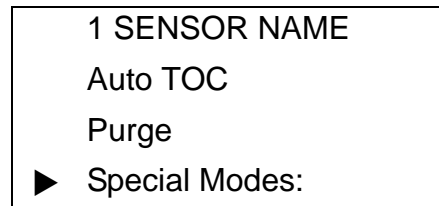

Fig 13-2 : Special Modes Menu

- 5) Specify **Clean** and press **Enter** once again to initiate this operational mode. Allow the Analyzer to operate in the Self-Clean Mode for 3 to 4 hours, longer if contamination is significant.

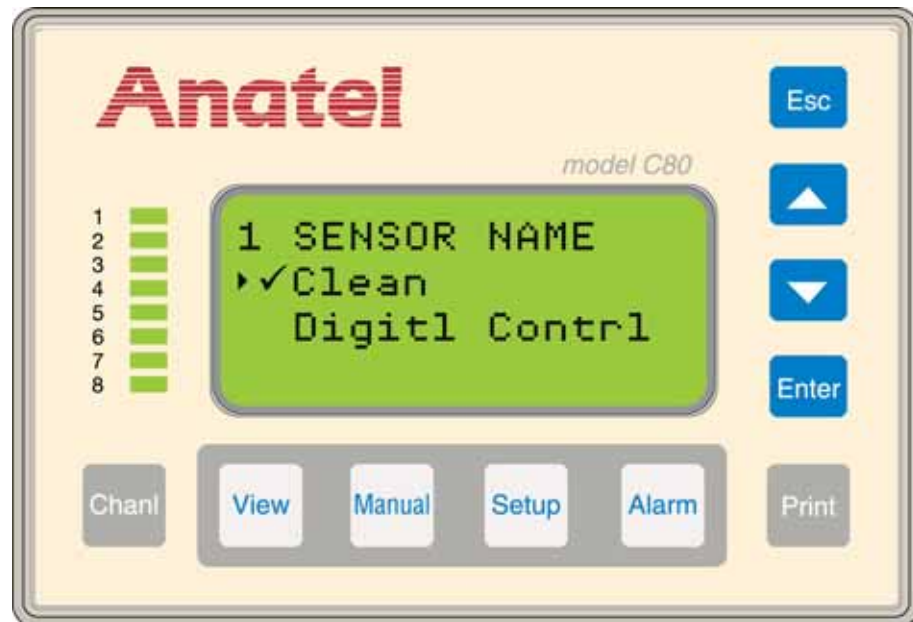

Fig 13-3 : Selecting the Self-Clean Mode

- Repeat [step 1](#) through [step 3](#) and select **Auto TOC** in the **Modes Menu** to terminate instrument self-cleaning and restore normal analysis.

13.4 Preparatory Maintenance Procedures



WARNING

Certain maintenance procedures require the removal of either of the TOC600 Analyzer's covers to access the instrument's internal components. These procedures may expose the operator to electrical shock if power is not removed before beginning the procedure. None of these procedures should be attempted by untrained personnel.

- UV Lamp
- Air Filters
- 15 Micron Filter
- (Optional) Printer

The following tools are required:

- 9/16" Open-End Wrench
- 5/64" Allen Wrench

To access the Analyzer's internal components:

- 1) Close the upstream isolation valve to stop water flow to the instrument.



WARNING

Only trained service personnel should execute this procedure. Unplug the Analyzer's power cord and exercise extreme caution since there are high voltages present inside the instrument's power supply. Personnel should be electrically grounded before opening the Analyzer to avoid potential electrostatic damage to any of its internal components.

- 2) Turn the TOC600 Analyzer **OFF** and disconnect the power cord from its AC source.
- 3) To disconnect the tubing to the inlet and outlet, loosen the compression fittings with a 9/16" wrench.
- 4) If necessary, remove the I/O Connector Block by loosening the four screws that secure it to the bottom of the instrument.
- 5) Loosen the four 5/64" hex bolts at each corner of the Analyzer cover to remove it.

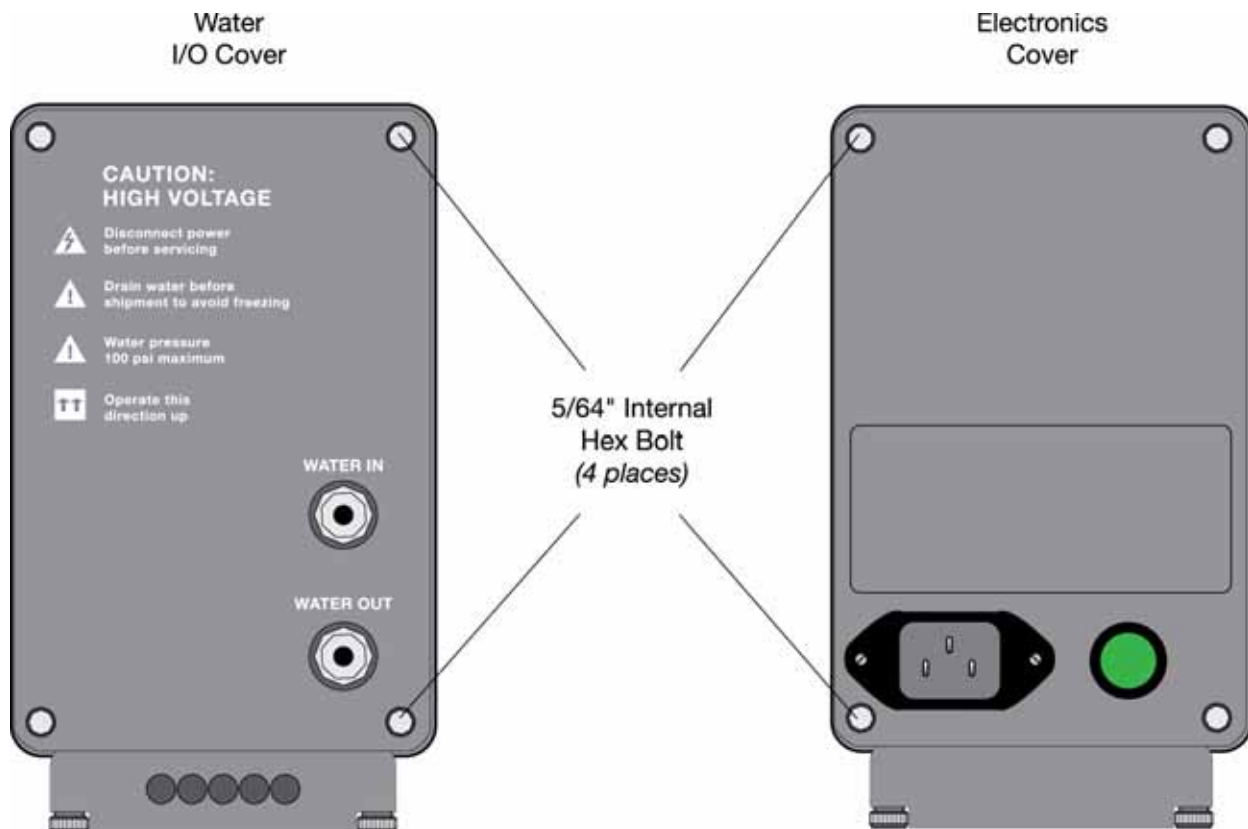

Fig 13-4 : Location of Hex Bolts

13.5 UV Lamp Replacement

Replacement Kit: P/N FG6002601



WARNING

Only trained service personnel should execute this procedure. Removing the UV lamp presents eye and shock hazards. Understand all safety warnings and cautions before proceeding.

The ultraviolet (UV) lamp in the TOC600 Analyzer requires periodic replacement to ensure accurate analyses. The TOC600 Analyzer logs UV lamp usage based on its total hours of operation. UV lamp performance begins to deteriorate after approximately six months of use.



Fig 13-5 : TOC600 Analyzer UV Lamp Assembly

CAUTION:

DO NOT touch the glass surface of the new UV Lamp. A lamp contaminated with fingerprints can be cleaned with isopropyl alcohol and a lint-free cloth.

The Anatel TOC600 Analyzer UV Lamp Replacement Kit is designed for on-site maintenance and contains the following parts:

- Ultraviolet Lamp Assembly
- Air Filters (2 each)
- 5/64" Hex Driver (Allen Wrench)
- *UV Lamp Replacement Kit Instructions*

Additional equipment required to perform the replacement procedure is:

- Long Phillips Screwdriver (5" minimum)
- Small Flat-Bladed Screwdriver
- 9/16" Open-End Wrench

CAUTION:

The UV Lamp contains mercury. When replacing it, dispose of the expired Lamp in accordance with applicable local regulations. Contact Customer Service to return UV Lamps to Hach Ultra; refer to "Return Procedures" on page 179 for more information.

Replace the UV Lamp when any of the following conditions occur:

- If the **Code 42: UV Lamp** appears in the Controller display after pressing Enter.
- If the **Code 42: UV Lamp** appears in the Controller display when changing the Analyzer's operational mode.
- If, each day, the message (**Code 42**)

URGENT: UV LAMP NEEDS REPLACEMENT

is output to the local printer shortly after midnight.

- If the **Code 33: Check UV Lamp** appears in the Controller display.
- If the time required for sample oxidation increases suddenly and does not return to normal.

The following alarm messages also may indicate a deteriorated UV Lamp, requiring that it be replaced:

- **Code 31: See Guide**
- **Code 32: See Guide**

These messages continue until the UV Lamp is replaced and the TOC600 Analyzer's internal counter is reset.



WARNING

In hot water (>50 °C) applications, allow the instrument to cool for 15 minutes before proceeding with the UV Lamp Replacement procedure.

To replace the UV Lamp:

- 1) Turn the TOC600 Analyzer Analyzer **OFF** and disconnect the AC power cord from its supply source.
- 2) Stop sample water flow to the instrument.
- 3) The UV Lamp is located at the Water I/O end of the TOC600 Analyzer. Disconnect the process water tubing and drain tubing from the inlet and outlet using a 9/16" open end wrench. It is not necessary to remove the prefilter assembly from the Water In port..

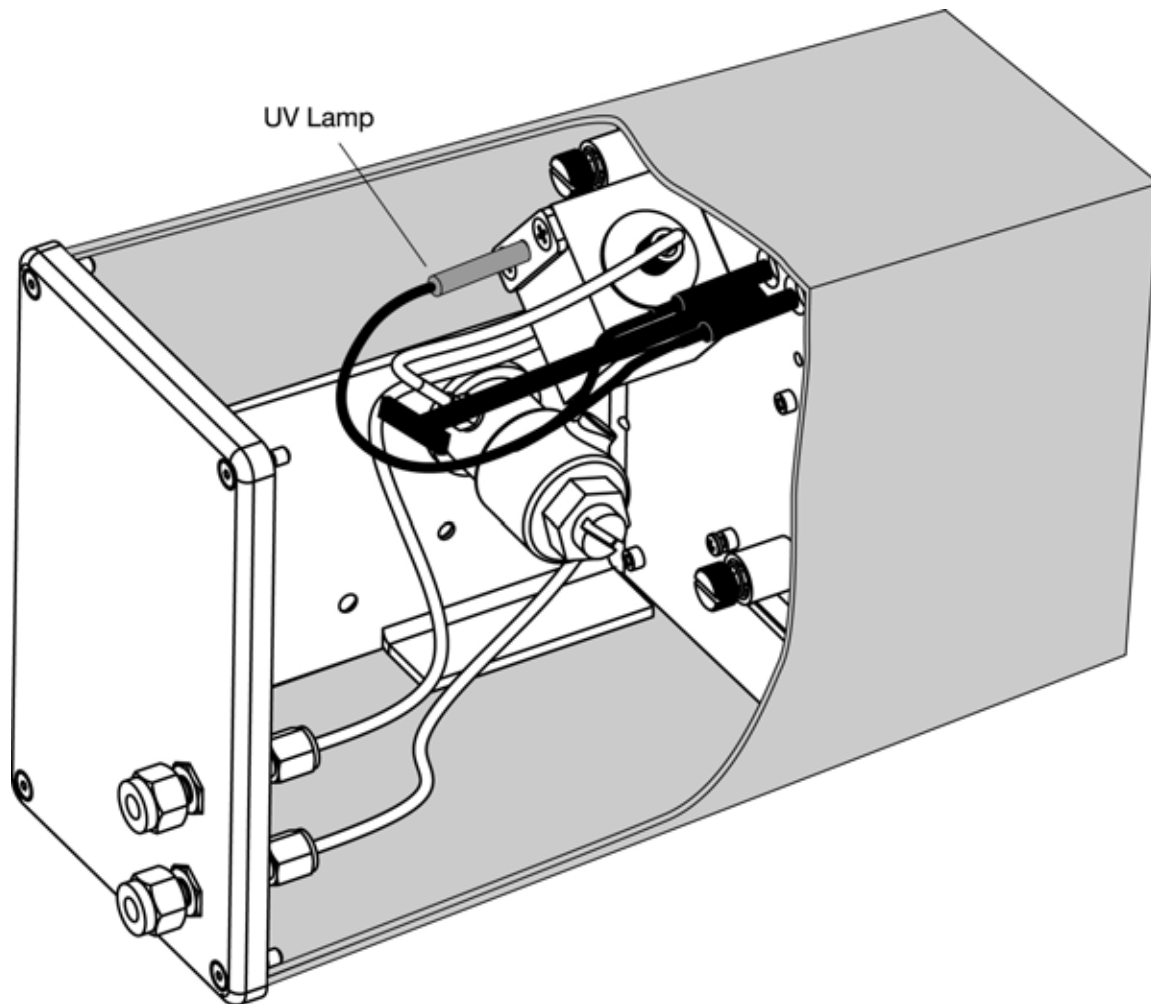

Fig 13-6 : TOC600 Analyzer UV Lamp Replacement Diagram

- 4) The UV Lamp is located at the Water I/O end of the TOC600 Analyzer. Loosen the four 5/64" hex bolts at each corner of the Analyzer cover. Carefully remove the cover.
- 5) Continue to support the **Water I/O Cover** and disconnect the Ground Wire spade connector.

Note:

*It is not necessary to unscrew the **WATER IN** and **WATER OUT** tubing connection nuts.*

- 6) Loosen the two Phillips head screws holding the UV lamp bracket to the Analyzer's cell assembly about 1-1/2 turns, as shown in [Figure 13-7](#). Do not remove the screw support.



Fig 13-7 : Loosening the UV Lamp Bracket

- 7) Pull the UV lamp straight out of the housing and remove it from the cell assembly, as shown in [Figure 13-8](#).

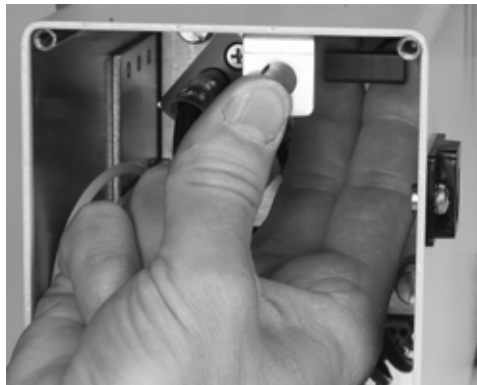

Fig 13-8 : Pulling the UV Lamp Connector Plug

- 8) Place fingers behind the tabs of the UV Lamp Connector stem and, with thumb braced against the enclosure, pull the plugs straight out of the receptacles.
- 9) Insert the new UV Lamp Assembly from the Replacement Kit into the housing in the cell, as shown in [Figure 13-9](#).

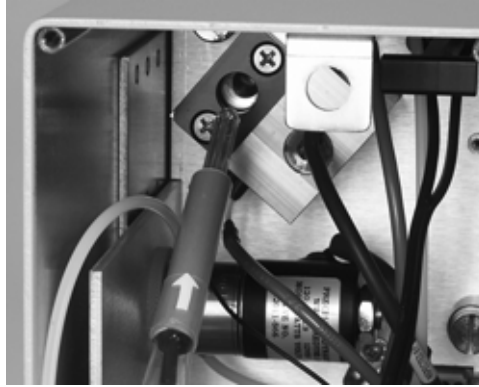

Fig 13-9 : Inserting the New UV Lamp Assembly

- 10) Turn the UV Lamp so that its arrow aligns with the center of the upper bracket screw, as shown in [Figure 13-10](#).

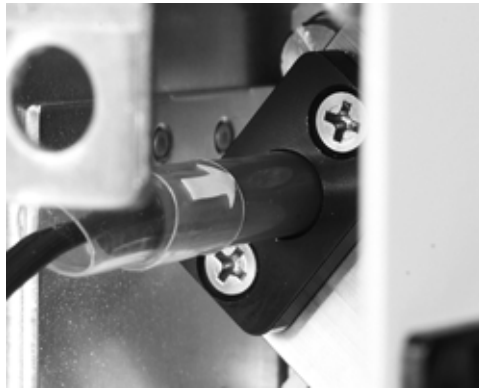

Fig 13-10 : Aligning the Arrow with the Bracket Screw

- 11) Holding the UV Lamp with the arrow aligned and tighten the Phillips-head screws about 1-1/2 turns to secure it in the cell housing.
- 12) Align the two UV Lamp Connectors and stem with the receptacles as shown in [Figure 13-11](#) and press straight against the stem to seat the plugs.

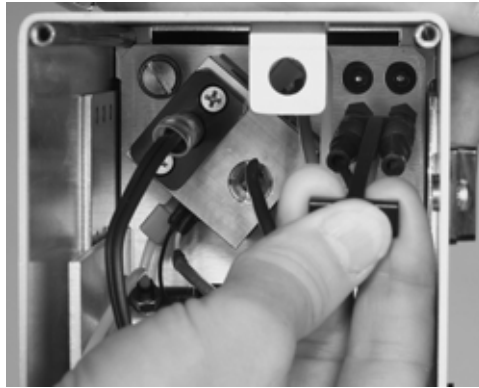

Fig 13-11 : Inserting the UV Lamp Connector

- 13) Exchange the Air Filter in the bottom of the instrument enclosure with a new one from the Replacement Kit (refer to the accompanying *Kit Instructions* to replace the second Air Filter.
- 14) Tuck the tubing inside the Analyzer enclosure and replace the **Water I/O Cover**.
- 15) Tighten the four 5/64" hex bolts evenly to seal the **Water I/O Cover** on the enclosure—*overtightening the hex bolts may break the seal.*
- 16) Reconnect the sample water supply tubing to the instrument's **Water In** port and the drain tubing to the **Water Out** port.
- 17) Plug the AC power cord into its supply and turn the TOC600 Analyzer Analyzer **ON**.

The Analyzer's internal counter tracks UV lamp usage. It must be reset each time a new lamp is installed in order to accurately report when light intensity has diminished below recommended levels.

To reset the instrument's UV Lamp counter:

- 1) Select the appropriate Analyzer in any View and press **Setup** to access its submenu.
- 2) Specify **Sensor Setup** and press **Enter**.
- 3) Specify **Analysis Setup** and press **Enter**.
- 4) Specify **More Setup** and press **Enter**.
- 5) Specify **Cell Setup** and press **Enter**.
- 6) Specify **Lamp Install** and press **Enter**.
- 7) Press **Enter** to confirm the new Lamp installation.



Fig 13-12 : Resetting the Lamp Counter

- 8) Press **Esc** repeatedly to exit the screen and return to the main menu.

13.6 Air Filter Cleaning

Replacement Kit: P/N FG7013501



WARNING

Only trained service personnel should execute this procedure. Cleaning the air filters presents shock hazards and potential ESD issues. Understand all safety warnings and cautions before proceeding.

Each TOC600 Analyzer Analyzer is equipped with air filters which can become clogged over time, reducing performance and stressing components. The filters should be checked periodically and cleaned when necessary to guarantee unobstructed air flow through the instrument. The frequency of air filter cleaning depends on the ambient environment in which the instrument is located. Dirtier air demands more frequent filter cleaning.

To service the TOC600 Analyzer's air filters:

- 1) Remove both the Water I/O and Electronics Covers as described in the preparatory procedures in ["Preparatory Maintenance Procedures" on page 153](#).
- 2) Locate the two air filters on the bottom of the Analyzer enclosure, one positioned at each end of the instrument.

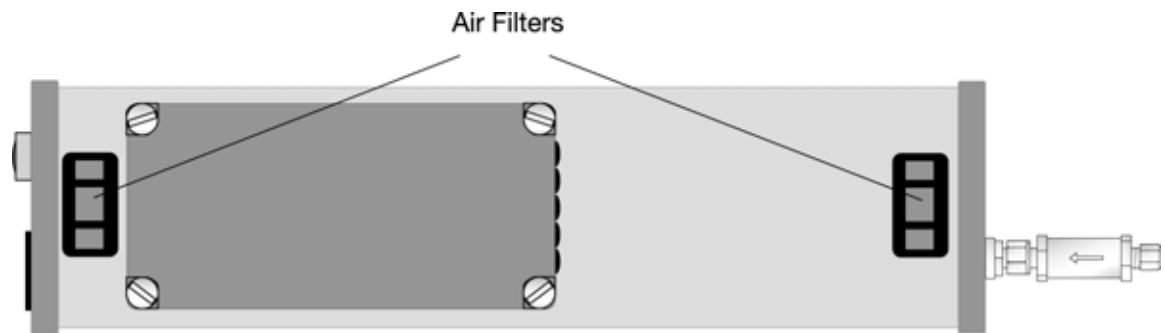

Fig 13-13 : TOC600 Analyzer Air Filters

- 3) Remove and rinse out the two air filters. Allow them to dry completely before reinstalling them in the Analyzer.
- 4) Replace the two Analyzer covers.
- 5) Restore the sample water supply and re-establish power to the Analyzer.

13.7 Inlet Filter Replacement

Replacement Kit: P/N FG7017201

The TOC600 Analyzer's 15 micron Inlet Filter prevents potential particulate contamination from entering the instrument. It should be checked yearly or if sample flow appears restricted. A replacement filter housing and 15 micron filter (P/N FG7017301) is also available from Hach Ultra.



WARNING

To avoid electrical shock, always disconnect the instrument from its power source before attempting to access internal components.

To replace the 15 Micron Inlet Filter:

- 1) Disconnect the TOC600 Analyzer's AC power cord from its supply source.
- 2) Turn off the (user-supplied) isolation valve or otherwise stop sample flow to the instrument.
- 3) Disconnect the sample tubing from the instrument by loosening the **WATER IN** compression nut using a 9/16" wrench. Set the sample tubing aside for reassembly later.

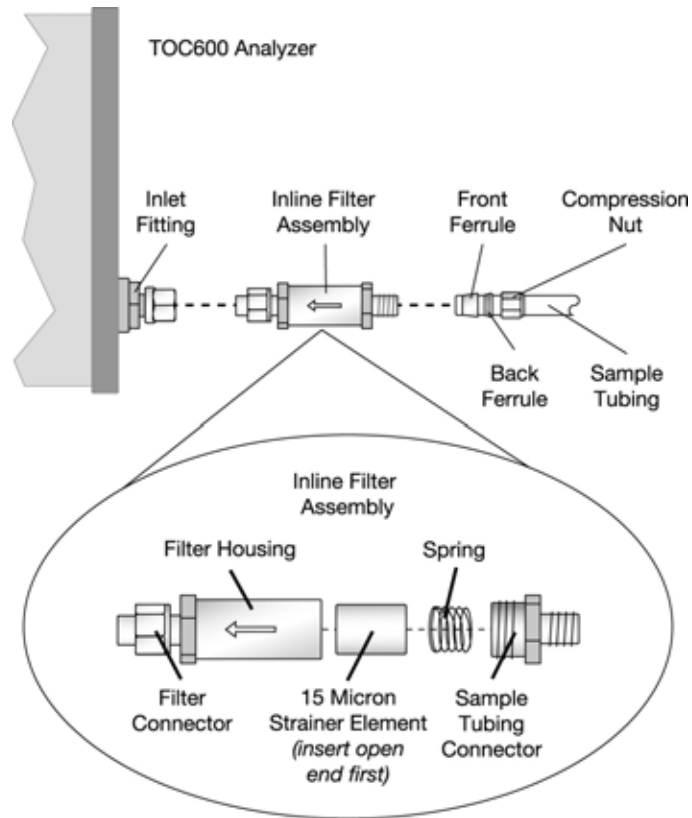

Fig 13-14 : Inlet Filter Assembly

- 4) Unscrew the nut from the inlet (threaded) end of the Filter and remove the ferrule and collar that are held inside the nut.

Note:

If the nut, ferrule and collar are not found as described in step 4, then step 4 through step 7 have already been performed at Hach Ultra. In this case, the Inlet Filter appears as shown. Skip to step 8.

- 5) Slide the nut on the outlet end of the Filter with the threads facing out.
- 6) Slide the collar on the outlet end of the Filter so that it fits inside the nut. The flat edge of the collar should face down inside the nut.

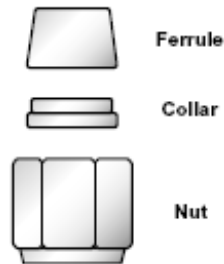

Fig 13-15 : Collar Position

- 7) Slide the ferrule on the outlet end of the Filter so that the narrow side of the “cone” faces up.
- 8) While gently but firmly pressing the filter housing toward the instrument, hand-tighten the Filter nut (with the collar and ferrule inside) onto the **WATER IN** bulkhead fitting.
- 9) Mark the surface of the Filter nut that is facing up with a pen or piece of tape to gauge how much to tighten the nut.
- 10) While continuing to press the Filter toward the instrument, tighten the nut one and a quarter full turns using the 9/16" wrench. Use the mark made on the nut in [step 9](#) to determine when the full 1-1/4 turns are completed. The pressure fuses the collar, ferrule and nut together and locks them on the Filter housing.

CAUTION:

Do not overtighten fittings, as leaks may result.

- 11) Connect the sample tubing to the inlet end of the Filter with the compression nut using the 9/16" wrench.
- 12) Restore power and sample flow to the TOC600 Analyzer and check for leaks. Tighten fittings as necessary.

The inline filter is now installed. The 15 micron strainer element inside the filter housing should be checked yearly and replaced if sample flow appears to be restricted.

14 Troubleshooting

14.1 General Information

In addition to the standard self-tests conducted by the TOC600 Analyzer during its analyses, an extended diagnostic and reporting facility is incorporated to inform the user about the nature of a problem. Alarm Codes, in conjunction with user-initiated diagnostic tests, serve to isolate the source of the problem.

The checksum value of the Analyzer's controlling EPROM and its current firmware version may be displayed by pressing the **Chan1 Key** twice. This ROM checksum is routinely calculated as part of the instrument's power-up diagnostics and is the same checksum value that would be produced by a device programmer. The ROM checksum and firmware version are also available on the Sensor Factory Configuration printout (see ["Printouts" on page 114](#)).

14.2 Alarm Codes

Functional range and logic checks are reviewed continuously to determine the functional status of each instrument during every analysis. If one or more alarms is detected, the Controller's display and the faulty TOC600 Analyzer's corresponding LED begin flashing (see ["Alarm Reporting" on page 101](#)). The appropriate Code is logged for display and output to the printer. Any reported problems fall into two code classifications: hardware and water chemistry.

Hardware alarms (Codes 1-99) are indicative of either an electromechanical or analytical failure of the Analyzer. These alarms could result from such conditions as an exhausted UV lamp, a faulty solenoid valve or a hardware malfunction.

Computational results are still reported, and a recovery is attempted by initiating a new analysis cycle. If the recovery is successful, the red Channel LED returns to green (although the alarm is logged for display on the Controller and output to the associated printer) and normal operation resumes.

If the recovery is unsuccessful, attempts persist and the results of the most recent successful analysis are displayed. The Controller display and the Channel LED continue to flash red until acknowledged by pressing the **Alarm Key**. Once acknowledged, the relevant Code is displayed and the Controller stops flashing. But the Channel LED is not restored to green until a successful analysis cycle is completed. If an alarm occurs during a diagnostic test, the Analyzer will not attempt another measurement until the displayed alarm is acknowledged by pressing the **Alarm Key**. After the problem has been corrected, the diagnostic test may be re-initialized.

Each instrument maintains a log consisting of the Code number, the total number of occurrences of that particular type of alarm and a time stamp of its initial occurrence. The log is erased whenever power is cycled on the instrument or when the **ME** command is issued (see ["Mode Set Commands" on page 146](#)).

Table 14-1 : Electromechanical Alarm Codes

Code	Instrument Display	Indication
1	See Guide	Possible ROM performance issue. Call the Hach Ultra Service Department.
2	See Guide	Possible RAM performance issue. Call the Hach Ultra Service Department.
3	See Guide	Possible electronic timing issue. Check for electronic emissions from adjacent equipment or environment which may cause data transfer problems. If issue persists, call the Hach Ultra Service Department.
4	See Guide	Possible disruption to the data log, which may be caused by a hardware performance issue or removal of the battery. Check the battery. If issue persists, call the Hach Ultra Service Department.
5	See Guide	Possible hardware performance issue. Call the Hach Ultra Service Department.
6	See Guide	Possible hardware performance issue involving power to the network. Call the Hach Ultra Service Department.
7	See Guide	Possible hardware performance issue. Call the Hach Ultra Service Department.
8	See Guide	Possible hardware performance issue. Call the Hach Ultra Service Department.
9	See Guide	Possible hardware performance issue. Call the Hach Ultra Service Department.
10	See Guide	Possible hardware performance issue or battery has been removed. Check the battery. If the issue persists, call the Hach Ultra Service Department.
11	Check Battery	The lithium battery has expired. Call the Hach Ultra Service Department.
12	See Guide	Possible hardware performance issue. Call the Hach Ultra Service Department.
13	See Guide	Possible hardware performance issue. Call the Hach Ultra Service Department.
14	See Guide	Possible hardware performance issue. Call the Hach Ultra Service Department.
15	See Guide	Possible hardware performance issue. Call the Hach Ultra Service Department.
16	See Guide	Possible hardware performance issue. Call the Hach Ultra Service Department.
17	Check DAC	Possible hardware performance issue. Check the wiring connections to the DAC module (refer to “Analog Outputs” on page 119). If the issue persists, call the Hach Ultra Service Department.
18	Check Network	Possible hardware performance issue). Check the network wiring connections (refer to “Network Installation” on page 35). If the issue persists, call the Hach Ultra Service Department.
19	See Guide	Possible hardware performance issue. Call the Hach Ultra Service Department.
20	Duplicate ID	Two instruments have been assigned the same Channel ID. Check the instrument IDs and ensure they are unique. If issue persists, check the network wiring connections (refer to “Network Installation” on page 35). If the issue continues, call the Hach Ultra Service Department.
137	Check Network	Check to ensure the network positive and negative wires are not reversed at the connector block (refer to “Network Installation” on page 35). If the issue persists, call the Hach Ultra Service Department.

Table 14-2 : Analysis Alarm Codes

Code	Instrument Display	Indication
21	See Guide	Possible hardware performance issue. Call the Hach Ultra Service Department.
22	See Guide	Possible hardware performance issue. Call the Hach Ultra Service Department.
23	See Guide	Possible hardware performance issue. Call the Hach Ultra Service Department.
24	See Guide	Possible hardware performance issue. Call the Hach Ultra Service Department.
25	See Guide	Possible hardware performance issue. Call the Hach Ultra Service Department.
26	See Guide	Possible hardware performance issue. Call the Hach Ultra Service Department.
27	Conductivity Range	Water has drained from the analysis cell or the current sample vial is dry. Ensure that water is flowing normally through the instrument and it is in the correct orientation. If the issue persists, call the Hach Ultra Service Department.
28	See Guide	Possible hardware performance issue. Call the Hach Ultra Service Department.
29	Water Conditions	Water has drained from the analysis cell or the current sample vial is dry. Ensure that water is flowing normally through the instrument and it is in the correct orientation. If the issue persists, call the Anatel Service Department. TOC detection limits may be too low for current water conditions. If the issue persists, call the Hach Ultra Service Department.
30	See Guide	Possible hardware performance issue. Call the Hach Ultra Service Department.
31	See Guide	Possible hardware performance issue. Call the Hach Ultra Service Department.
32	See Guide	Possible hardware performance issue. Call the Hach Ultra Service Department.
33	Check UV Lamp	Replace the UV lamp.
34	Water Conditions	Possible hardware performance issue or TOC detection limits may be too high for current water conditions.
35	Water Conditions	Possible hardware performance issue or TOC detection limits may be too low for current water conditions.
36	Water Conditions	Current water conditions interfere with the TOC measurement.
37	Water Temp	Sample water temperature < 5 °C or possible hardware performance issue. A heat exchanger may be required. If issue persists, call the Hach Ultra Service Department.
38	Water Temp	Sample water temperature >95 °C or possible hardware performance issue. A heat exchanger may be required. If issue persists, call the Hach Ultra Service Department.
39	Conductivity Range	Conductivity of the water sample is too high for TOC measurement. Water has drained from the analysis cell or the current sample vial is dry. Ensure that water is flowing normally through the instrument and it is in the correct orientation. If the issue persists, call the Hach Ultra Service Department.
40	Conductivity Range	Conductivity of the water sample is too low for TOC measurement. Water has drained from the analysis cell or the current sample vial is dry. Ensure that water is flowing normally through the instrument and it is in the correct orientation. If the issue persists, call the Hach Ultra Service Department.
42	UV Lamp	Replace the UV lamp.
44	Sys Suitability	The system suitability test should be repeated.

Table 14-2 : Analysis Alarm Codes

Code	Instrument Display	Indication
45	See Guide	Possible hardware performance issue. Call the Hach Ultra Service Department.
46	See Guide	Possible hardware performance issue. Call the Hach Ultra Service Department.
47	See Guide	Possible hardware performance issue. Call the Hach Ultra Service Department.
48	See Guide	Possible hardware performance issue. Call the Hach Ultra Service Department.
49	See Guide	Possible hardware performance issue. Call the Hach Ultra Service Department.
50	Test Interrupt	A calibration was interrupted by a power loss. Check the standards bottle level and proper operation of the calibration process.
51	Change Password	The 90-day limit has expired and the Password(s) must be changed (see “Password Security” on page 51).

14.3 Troubleshooting

With the exception of Codes **4**, **10**, **11** and **18**, the **Electromechanical Alarms** are not user-serviceable. A **Code 4** alarm, if caused by changing the lithium battery, will result in lost data that cannot be recovered. A **Code 10** alarm can be corrected by restoring the factory default parameters (see [“Factory Defaults” on page 49](#)), then modifying them as necessary. A **Code 18** or **Code 137** alarm indicates faulty communications; check Anet wiring and contact Hach Ultra if the problem persists.

The following alarms warrant a general check to verify that the isolation valve is open and the instrument’s sample valve is functional. This is done by watching the output of the drain line through an entire analysis. Flow should be unrestricted during the **Sample Time**, there should be absolutely no flow (watch for dripping from the drain tubing) during oxidation, and there should be no bubbles evident in the drain line at the start of a new analysis. In the case of alarms **34–36**, an hour or more of self-cleaning is recommended (see [“Self-Cleaning Mode” on page 152](#)).

Table 14-3 : Troubleshooting Electromechanical Alarms

Code	Corrective Action
27/29	Check the water supply to the instrument for unobstructed, bubble-free flow.
32/33	Check UV lamp connections; replace the UV lamp assembly if necessary.
34	If TOC is greater than 1000 ppb or the Analyzer has been idle for a long period prior to analysis, place the instrument in the Self-Clean Mode for at least one hour before attempting another analysis. If the problem persists, it is either a hardware problem or an unsuitable application; contact Anatel.
35	The sample valve is plugged or the UV lamp is going bad. Replace the UV lamp if necessary.
36	In some cases, the accuracy of the reported TOC value may be affected by the presence of certain ions. This condition occurs primarily in water with less than 5 megohm-cm resistivity. If it persists, the sample water is unsuitable for TOC600 Analyzer analysis.

Table 14-3 : Troubleshooting Electromechanical Alarms

Code	Corrective Action
37/38	Temperatures outside the range of 5 °C to 95 °C are considered hardware failures. If not, the sample is beyond the instrument's specifications.
39/40	An alert that the quality of the sample water is outside the instrument's optimum performance range. Measure the resistivity of the sample water. Large discrepancies in the measurements may be due to a hardware failure; contact Anatel.
41	Reports a suspended analysis cycle and does not affect instrument operation.
42	Replace the UV lamp (see " UV Lamp Replacement " on page 155).
44–50	Repeat the test. Contact Hach Ultra if failure continues.

During an analysis, the TOC and/or conductivity (or resistivity) must fall within an acceptable range depending on the chemical being measured. A screen identifying the chemical and the failure value is displayed if the range is exceeded.

XXXXX analysis
failed. XXX ppb
TOC out of range
Press Enter

Fig 14-1 : Failure Identified

Possible causes for this alarm condition are:

- Contamination of the vial and/or sample assembly
- A blockage or restriction in the sample delivery line, air inlet filter or inlet check valve
- A restriction in the drain line

The following limits apply to each of the TOC600 Analyzer's Calibration tests. If the limits are exceeded, a message is logged and printed, and the results of the test will not be saved.

Table 14-4 : TOC600 Calibration Tests

Test	Limits
Conductivity Calibration	The cell constant also must not deviate from the previous calibration by more than 5%, or the factory calibration by more than 10%.
TOC Calibration	The percent change in slope must not deviate from the factory calibration by more than 15%.
System Suitability	If the calculated response efficiency is above 115% or below 85%, the Analyzer fails the test. A Code 44: Sys Suitability is reported every eight hours until a new system suitability is successfully performed.
TOC Validation	The recognized response must be within $\pm 10\%$ of the given standard value. A message is logged if the instrument fails the validation test.

Any problems should be referred to Hach Ultra. Call 800.866.7889 or +1-541.472.6500 with the following information:

- The instrument's serial number
- Sample resistivity and temperature
- Current and historical TOC data
- Current and historical alarm codes
- A Setup Printout
- Process conductivity or resistivity and temperature
- Current and historical calibration, validation and system suitability results
- Any other significant changes in operating conditions

If existing problems warrant equipment return, contact the Hach Ultra Service Department and refer to ["Return Procedures" on page 179](#).

CAUTION:

Drain all water from the Analyzer when taking the instrument out of service (see ["Draining the Instrument" on page 171](#)). Residual water will freeze inside the unit, expand and damage the measurement cell. Such damage is time-consuming to repair and is not covered by the warranty.

14.3.1 Draining the Instrument

CAUTION:

Remember that an instrument stored in a warehouse in the winter can be freeze-damaged if water is left inside and a unit shipped from a warm climate to a cold climate is exposed to extreme temperatures en route.

It is extremely important to drain the TOC600 of all water whenever the instrument is removed from its source for two reasons:

- When removing the Analyzer from service for temporary or long term storage (longer than a month), any water remaining in the measurement cell is a medium for bacteria growth. In addition, elements contained in the sample water will settle and adhere to the instrument components causing contamination. It is strongly recommended to self-clean the Sensor for an extended period of time when reinstalling it to ensure accurate and stable data.
- Purging the water out of the Analyzer also avoids freeze damage. If the Sensor is stored or shipped in an extremely cold environment, the water inside the instrument will expand and could severely damage sensitive components. Replacing these components is expensive and will increase the amount of repair time as much as a week.

To purge the TOC600 of entrained water:

- 1) Press the ON/OFF button to turn the TOC600 off.
- 2) Close the (user-supplied) upstream isolation valve to terminate the water supply to the Analyzer.
- 3) Disconnect the sample tubing from the TOC600's WATER IN connection. A small amount of water will be present in the instrument and its plumbing. The water drains from this connection due to gravity and its location at the bottom of the Sensor's measurement cell. Take steps to catch this water when disconnecting the tubing so it doesn't spill onto the work surface.
- 4) Press the ON/OFF button once again to restore power to the Analyzer.
- 5) Press the **Manual Key** to access its menu selections.
- 6) Use the **Up** and **Down Keys** to specify Modes.
- 7) Press **Enter** to display its submenu.
- 8) Specify **Purge** and press **Enter** to flush the instrument.
- 9) Raise the open end of the tubing connected to the WATER OUT port as high as possible above the Sensor. Water should drain from the WATER IN port. If the entrained water does not readily drain, gently blow into the open end of the tubing to force the water out of the measurement cell. The cell has been purged when air is exhausted from the WATER IN connection.



WARNING

Do not blow into the drain tubing if there are any harmful materials in the water sample—exercise care and use pressurized oxygen or nitrogen instead.

- 10) When the water is completely drained, turn the Analyzer off, disconnect it from its power supply, and cap the plumbing connections. The instrument is ready for shipment or storage.

Note:

Once the water is purged from the Analyzer cell, an "Error 27: False Conductivity" may be reported. This is normal due to the dry measurement cell.

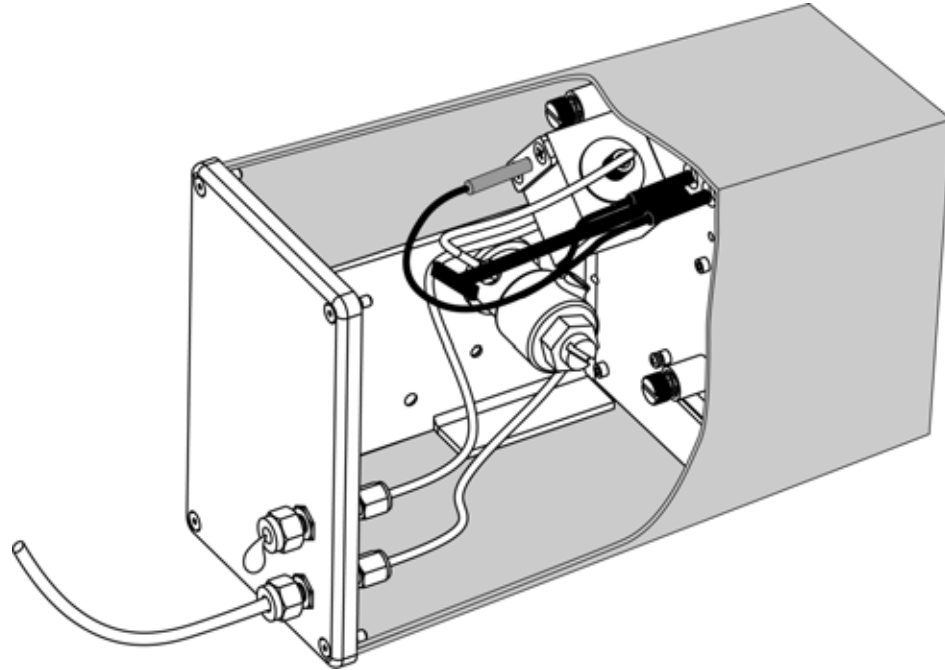

Fig 14-2 : Purging the TOC600 Measurement Cell

For assistance in performing this procedure, call Hach Ultra at 800.866.7889 or +1-541.472.6500 for assistance.

14.4 Sensor Diagnostics

Diagnostic tests conducted on individual Analyzers can be quite helpful in isolating the source of a reported alarm. The C80 Controller software is equipped with a series of user-initiated diagnostic and reporting capabilities that are designed to facilitate the resolution of detected problems. These internal tests can be conducted to verify the instrument's electronic, analysis and communications components to assure that they are functioning properly. The results of these diagnostic tests are reported on the display as well as on an automatic printout.

To perform TOC600 Analyzer diagnostics:

- 1) With the suspect Analyzer selected in any View, press the **Setup Key** to access its menu selections.
- 2) Use the **Up** and **Down Keys** to specify **Sensor Setup**.
- 3) Press **Enter** to display its submenu.
- 4) Specify **Diagnostics** and press **Enter** to display the available options.
- 5) Specify the desired diagnostic area and then press **Enter** to display its function.

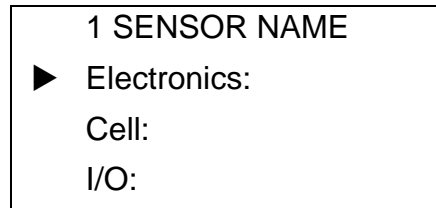

Fig 14-3 : Diagnostics Menu

14.4.1 Electronics Tests

The Analyzer's electronic diagnostics are divided into Voltage, Memory/Alarm and Display/Print tests.

To conduct a diagnostic test on any of the TOC600 Analyzer's electronic systems:

- 1) With the Analyzer's **Diagnostics Menu** displayed, specify Electronics and press **Enter** to access its options. Each of the **Electronics Menu** selections offers diagnostic options, listed in [Table 14-5](#).

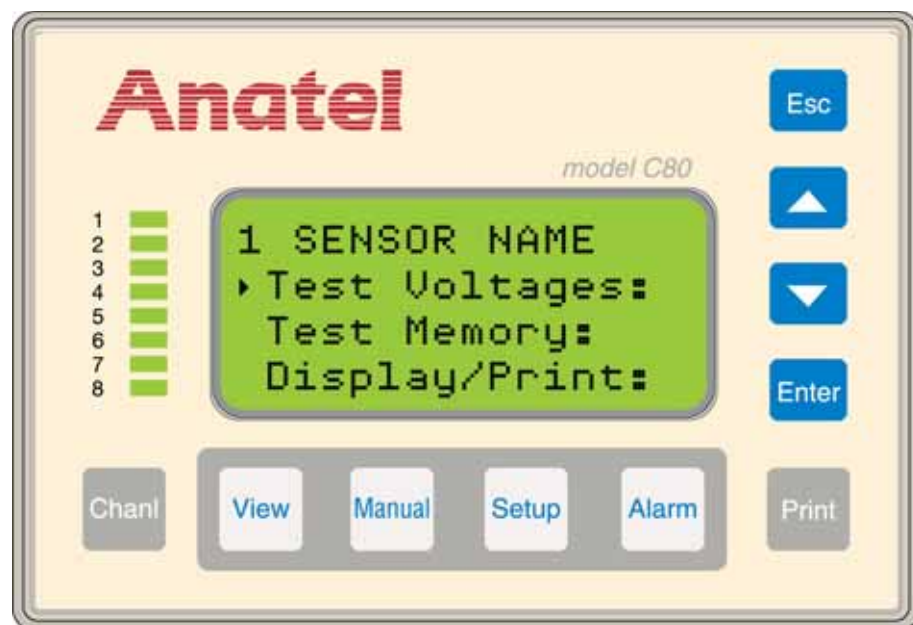

Fig 14-4 : Electronics Diagnostic Screen

Table 14-5 : Electronics Menu Diagnostic Options

Menu Item	Test Option	Function
Test Voltages	Voltages	Pass/fail test which compares the current instrument voltages to their nominal baseline levels
	Baselines	Prints a list of the instrument's baseline voltage values
Test Memory	N/A	Verifies that the instrument's RAM is functional
Display/Print	Display Test	Verifies operation of the Analyzer's and the Controller's LCD by darkening all of the pixels in the display
	Printer Test	Confirms all characters are printing

- 2) Press **Enter** to execute the chosen operation. The results of the test are presented on the Controller's display and a printout is generated. Contact Hach Ultra if the TOC600 Analyzer fails any of these tests.
- 3) Press **Esc** twice to return to the **Electronics Menu** to perform another circuitry test, or press it three times to return to the **Diagnostics Menu**.

14.4.2 Cell Tests

These tests facilitate manual control of the TOC600 Analyzer's ultraviolet lamp, as well as its sample valves and pump and calibration resistor. Diagnostics testing interrupts the current TOC analysis; normal analysis resumes upon termination of the test.

To check the status of these two components:

- 1) With the Analyzer's **Diagnostics Menu** displayed, specify **Cell** and press **Enter** to access its options. The Cell Menu offers the options listed in [Table 14-6](#).

Table 14-6 : Cell Menu Diagnostic Options

Menu Item	Test Function
Lamp Test	Sets the UV lamp to "On" or "Off"
Valve	Sets the valves to "On" or "Off"

- 2) Use the **Up** and **Down Keys** to specify the desired diagnostic selection.

CAUTION:

Make sure that the sample vessel is securely installed before initiating the Valve test.

- 3) Press **Enter** to select the component's state. For the Valve test, the states of the three solenoid valves and pump are shown. For both the Lamp and Valve tests, there are two possible test settings:
 - On
 - Off

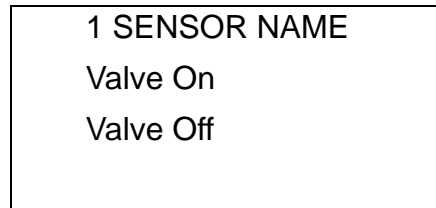

Fig 14-5 : Valve Test Diagnostics Menu

- 4) Press **Esc** twice to return to the **Cell Menu** to perform the other function, or press it three times to return to the **Diagnostics Menu**.

14.4.3 I/O Tests

These diagnostics verify the operation of the TOC600 Analyzer's serial and digital I/O circuits. An external loopback connector is required for these tests and should be attached to the appropriate Analyzer port.

To check operation of the I/O connections:

- 1) With the Analyzer's **Diagnostics Menu** displayed, specify I/O and press **Enter** to access its options. The **I/O Menu** offers the three options listed in [Table 14-7](#).

Table 14-7 : I/O Menu Diagnostic Options

Menu Item	Test Function
RS-232 Test	Runs an individual loopback test on each of the connected serial ports. A jumper must be applied to the RxD and TxD terminals on each of the instrument's serial ports as shown.
Digital I/O	Verifies the instrument's digital input and output connectors. A jumper must be applied across the Analyzer's digital input and output terminals as shown.
DAC Out Test	Verifies the instrument's analog output to an optional external DAC module.

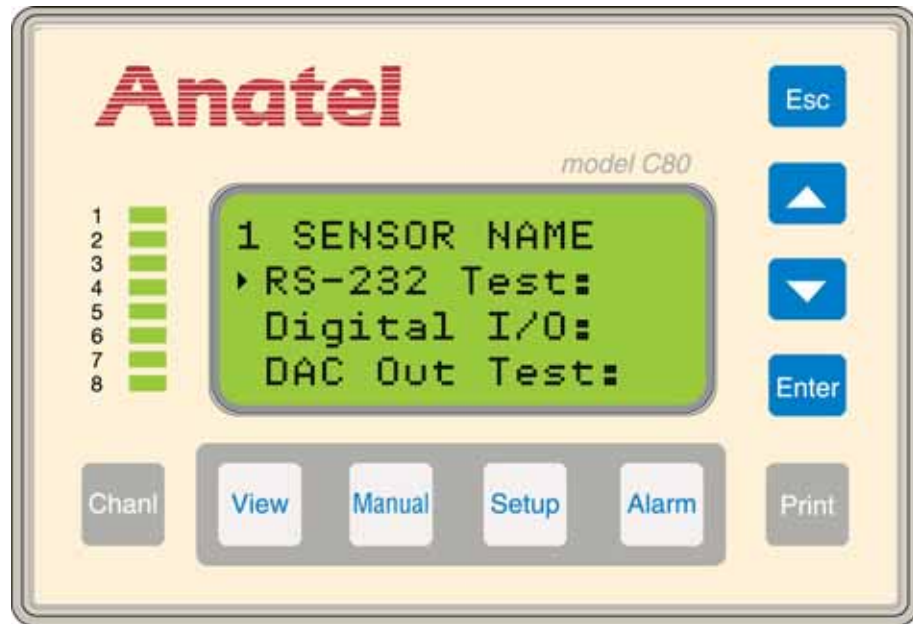

Fig 14-6 : I/O Diagnostics Screen

- 2) Use the **Up** and **Down Keys** to specify the desired communications test.
- 3) Press **Enter** to execute the test. The results are presented on the Controller display and a corresponding printout is generated. If the instrument fails either of the tests, check the wiring before contacting Hach Ultra for assistance.
- 4) Press **Esc** repeatedly in order to return to previous display screens.

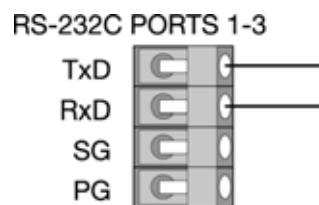

Fig 14-7 : RS-232 Loopback Wiring

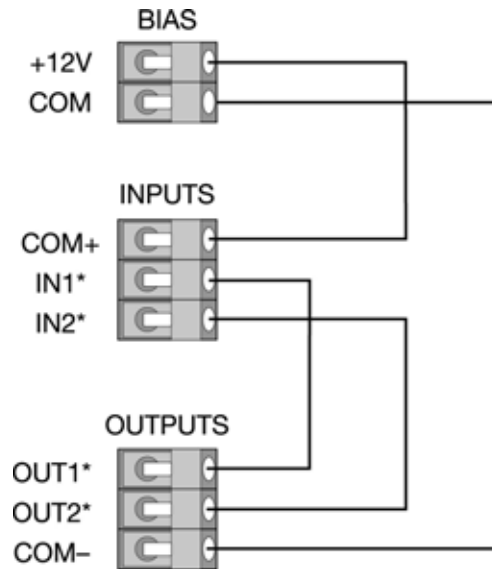

Fig 14-8 : Digital I/O Loopback Wiring

DAC Output Test

The analog signal that the TOC600 Analyzer sends to an optional external DAC module can be verified over the chosen output range. Simply attach a multimeter to the module's input terminals to monitor the accuracy of the instrument's display.

To test the DAC output:

- 1) With the Analyzer's I/O **Diagnostics Menu** displayed, specify **DAC Out Test** and press **Enter**.



Fig 14-9 : DAC Output Test Screen

- 2) Use the **Up** and **Down Keys** to specify the desired mA output. The available selections are within the minimum and maximum values over the specified range (4–20 or 0–20) in 1 mA increments.
- 3) With the appropriate mA output showing on the Controller, press **Enter** and the TOC, temperature and conductivity readings proportional to the chosen analog output are displayed. The displayed readings should reflect those observed at the external DAC module.
- 4) Repeat the procedure to verify the DAC output over its entire range, if desired.

Appendix A: Service Procedures

A.1 Return Procedures

To return the TOC600 Analyzer for service, first obtain a returned material authorization number (RA#). The RA# is necessary for any instrument that requires repair or calibration by an authorized service center. Include the RA# on the shipping label when the instrument is returned.

While the RA# process is described in this section, for the most up-to-date RA# process information, including copies of all required forms, call Hach Ultra at 800.866.7889 or +1 541.472.6500.

To return an instrument for credit, please contact the local sales representative.



WARNING

The following actions must be performed when returning any unit for any reason to prevent personal injury and/or damage to the unit.

- All analyzers returned for repair or replacement must be thoroughly cleaned with all process material removed. Drain the TOC600 Analyzer as described in [“Draining the Instrument” on page 171](#).
- Sludge contains bacteria that could be hazardous to Hach Ultra personnel. If a contaminated unit is received, Hach Ultra reserves the right to have the unit removed and destroyed by a hazardous material disposal team at the shipper's expense.

A.2 Technical Support Information

Technical Support Engineers are available to provide high quality advice and recommendations for applications, product operation, measurement specifications, hardware and software, factory and customer site training.

Please provide name, company, phone, fax, model number, serial number and comment or question.

Call +1 (541) 472-6500
Toll Free (800) 866-8854 (US/CA)
Fax +1 (541) 474-7414
6:00 AM to 5:00 PM Pacific Time
Monday through Friday
Email: customerservice@hachultra.com

Appendix B: Specifications and Accessories

B.1 Performance Specifications

The Anatel TOC600 Analyzer is specifically designed for use in applications that monitor ultrapure water with a typical conductivity less than 0.2 microsiemens/cm (as high as 5.0 $\mu\text{S}/\text{cm}$ for pH neutral waters) compensated to 25 °C.

At a minimum, the TOC600 System consists of a single Analyzer and a C80 Controller. The maximum configuration may contain up to 8 Analyzers and 8 Controllers in addition to a host computer and associated input/output devices.

Note:

TOC600 Analyzer specifications are subject to change without notice.

TOC Mode	
Operating Range	1 to 1000 ppb as carbon
Resistivity	0.01 to 18.2 M Ω -cm
Conductivity	0.05 to 150 $\mu\text{S}/\text{cm}$ (@ 25 °C)
Display Resolution	1 ppb
Online Repeatability†	$\pm 1\%$ or 1ppb (whichever is greater)
Maximum Input Conductivity	0.2 $\mu\text{S}/\text{cm}$ for all waters 1.0 $\mu\text{S}/\text{cm}$ for all neutral waters 5 $\mu\text{S}/\text{cm}$ for water with CO ₂ as the sole conductive species
Ambient Operating Temperature	15 °C to 40 °C (59 °F to 104 °F) 15 °C to 35 °C (59 °F to 95 °F)
Sample Water Temperature:	5 °C to 95 °C (41 °F to 203 °F)
Sample Inlet Flow Rate:	60 mL/min to 300 mL/min
Sample Inlet Pressure:	10 psi to 100 psi (69 to 690 kPa)

† Repeatability of reading on an individual instrument

Conductivity (Purge) Mode

Conductivity Mode	Temperature Compensated to 25 °C or Uncompensated
Conductivity Range	0.05 to 150 $\mu\text{S}/\text{cm}$ (@ 25 °C)
Display Resolution	0.01 $\mu\text{S}/\text{cm}$
Resistivity Range	0.01 to 18 M Ω -cm (@ 25 °C)
Display Resolution	0.1 to 14.9 M Ω -cm, 1.0 M Ω -cm from 15 to 18 M Ω -cm
Conductivity Accuracy‡	2% over Full range (Uncompensated)

‡ Repeatability of reading from instrument-to-instrument

Calibration and Validation**TOC**

Up to Four-Point Calibration:	0 ppb C (blank), 250 ppb C, 500 ppb C, 750 ppb C (all sucrose)
One- to Three-Point Validation:	250 ppb C, 500 ppb C, 750 ppb C (sucrose)
System Suitability:	500 ppb C (sucrose), 500 ppb C (1-4,benzoquinone) standards Blank
Conductivity	
One-Point Calibration, Cell Constant:	100 μ S/cm solution

B.2 Physical Specifications**General**

Installation Category:	II, IEC 1010
Pollution Degree:	2, IEC 664

Anet Network Capacities

Type:	RS-485
Maximum Sensors:	8
Maximum C80 Controllers (any configuration):	8
Maximum Network Length:	1 km (3,000 ft)
Network Cabling:	Shielded Twin-axial, Twist-Lock BNC

B.2.1 Panel Mount C80 Controller

P/N FG1000202 (120VAC, 60Hz), P/N FG1000302 (230VAC, 50Hz)

The Model C80 Controller provides multiple Sensor display, individual instrument setup, system alarm indication and printer control functions for up to 8 Sensors via an RS-485 Network.

Displays

Main	4-line x 16-character Super-Twist LCD
Channel	8 Bi-color (red/green) LEDs

Physical

Operating Temperature	0°C to 40°C (32°F to 104°F)
Maximum Relative Humidity	90% RH
Maximum Altitude	4,000 m (13,125 ft)
Power	9 VDC Power Pack (120 VAC \pm 10%, 60 Hz standard, 230 VAC \pm 10%, 50 Hz optional)

Physical	
Power Consumption	7.6 W max.
Case	ABS front panel with Lexan [®] overlay
Size	120 mm L x 81 mm W x 48 mm D (4.7" L x 3.2" W x 1.9"D) 2.5" total depth behind panel (allow 4–5" to avoid crimping)
Weight	0.75 kg (1.5 lb)
Mounting	Panel
Connections	
Communications	Shielded Twin-axial, Twist-Lock BNC

B.2.2 TOC600 Analyzer

P/N FG1100600

Display	
Main	1-line x 16-character Super-Twist LCD
Backlighting	Yellow LED
Character Height	0.163"
Physical	
Operating Temperature	15 °C to 40 °C (59 °F to 104 °F)
Maximum Relative Humidity	100% RH (non-condensing)
Maximum Altitude	4,000 m (13,125 ft)
Size	193 mm H x 419 mm W x 119 mm D (7.6 in. H x 16.5 in. W x 4.7 in. D)
Weight	6.58 kg (14.5 lb)
Analysis Cell Volume	0.4 mL
Power	100 to 240 VAC ±10%, 50/60 Hz
Power Consumption	30W
Power Cord	
100 to 120 VAC Main	Rating: 125 VAC, 10 Amp Foil Shield 100%, Braid Shield 85% Connectors: IEC 320–C13 and NEMA 5–15P
208 to 230 VAC Main	Rating: 250 VAC, 10 Amp Foil Shield 100%, Braid Shield 85% Connectors: IEC 320–C13 and CEE 7/7or CEI 23–16/VII (or like, depending on country)

I/O Connections	
Analog	Opto-isolated 4-20 mA output Non-isolated 12 VDC output @ 1/2 Amp max.
Digital I/O	Two opto-isolated inputs Two opto-isolated outputs
Serial Interfaces	RS485 opto-isolated Network RS232 Data Acquisition RS232 Printer RS232 Diagnostics

B.3 Accessories

B.3.1 Thermal Printer

P/N FG2009401

The Seiko Instruments Model DPU-414 Type II is a 40-column thermal printer. It can operate as a standalone reporting device with the TOC600 Analyzer.

Print	
Method	Thermal Serial Dot-Matrix
Format	9 dots high x 7 dots wide
Speed	52.5 characters per second (cps)
Width	89.6 mm
Paper Size	112 mm, 40-column
Buffer	7400 characters
Physical	
Temperature Range	0 °C to 40 °C (32 °C to 104 °C)
Humidity	30 to 80% RH (non-condensing)
Power (via wall transformer)	120 VAC, 60 Hz Standard 230 VAC, 50 Hz Optional
NiCad Battery (643P only)	4.8 VDC, 1.5 Amp
Maximum Power Consumption	Negligible
Dimensions	160 mm W x 170 mm L x 66.5 mm D (6.3" W x 6.7" L x 2.6" D)
Connections	
Interface	RS232 Serial, 1200 Baud

To order, contact a local Hach Ultra representative or contact the factory at 800.866.7889 or +1-541.472.6500.

Appendix C: Certifications

C.1 Overview

This section contains the WEEE statement. For more information, contact a local Hach Ultra representative or contact the factory at 800.866.7889 or +1-541.472.6500.



Electrical equipment marked with this symbol may not be disposed of in European public disposal systems after 12 August of 2005. In conformity with European local and national regulations (EU Directive 2002/96/EC), European electrical equipment users must now return old or end-of life equipment to the Producer for disposal at no charge to the user.

Note: For return for recycling, please contact the equipment producer or supplier for instructions on how to return end-of-life equipment for proper disposal.

Important document. Retain with product records.

GERMAN

Elektrogeräte, die mit diesem Symbol gekennzeichnet sind, dürfen in Europa nach dem 12. August 2005 nicht mehr über die öffentliche Abfallentsorgung entsorgt werden. In Übereinstimmung mit lokalen und nationalen europäischen Bestimmungen (EU-Richtlinie 2002/96/EC), müssen Benutzer von Elektrogeräten in Europa ab diesem Zeitpunkt alte bzw. zu verschrottende Geräte zur Entsorgung kostenfrei an den Hersteller zurückgeben.

Hinweis: Bitte wenden Sie sich an den Hersteller bzw. an den Händler, von dem Sie das Gerät bezogen haben, um Informationen zur Rückgabe des Altgeräts zur ordnungsgemäßen Entsorgung zu erhalten.

Wichtige Informationen. Bitte zusammen mit den Produktinformationen aufbewahren.

FRENCH

A partir du 12 août 2005, il est interdit de mettre au rebut le matériel électrique marqué de ce symbole par les voies habituelles de déchetterie publique. Conformément à la réglementation européenne (directive UE 2002/96/EC), les utilisateurs de matériel électrique en Europe doivent désormais retourner le matériel usé ou périmé au fabricant pour élimination, sans frais pour l'utilisateur.

Remarque : Veuillez vous adresser au fabricant ou au fournisseur du matériel pour les instructions de retour du matériel usé ou périmé aux fins d'élimination conforme.

Ce document est important. Conservez-le dans le dossier du produit.

ITALIAN

Le apparecchiature elettriche con apposto questo simbolo non possono essere smaltite nelle discariche pubbliche europee successivamente al 12 agosto 2005. In conformità alle normative europee locali e nazionali (Direttiva UE 2002/96/EC), gli utilizzatori europei di apparecchiature elettriche devono restituire al produttore le apparecchiature vecchie o a fine vita per lo smaltimento senza alcun costo a carico dell'utilizzatore.

Nota: Per conoscere le modalità di restituzione delle apparecchiature a fine vita da riciclare, contattare il produttore o il fornitore dell'apparecchiatura per un corretto smaltimento.

Documento importante. Conservare con la documentazione del prodotto.

DANISH

Elektriske apparater, der er mærket med dette symbol, må ikke bortskaffes i europæiske offentlige affaldssystemer efter den 12. august 2005. I henhold til europæiske lokale og nationale regler (EU-direktiv 2002/96/EF) skal europæiske brugere af elektriske apparater nu returnere gamle eller udtjente apparater til producenten med henblik på bortskaffelse uden omkostninger for brugeren.

Bemærk: I forbindelse med returnering til genbrug skal du kontakte producenten eller leverandøren af apparatet for at få instruktioner om, hvordan udtjente apparater bortskaffes korrekt.

Vigtigt dokument. Opbevares sammen med produktdokumenterne.

SWEDISH

Elektronikutrustning som är märkt med denna symbol kanske inte kan lämnas in på europeiska offentliga sopstationer efter 2005-08-12. Enligt europeiska lokala och nationella föreskrifter (EU-direktiv 2002/96/EC) måste användare av elektronikutrustning i Europa nu återlämna gammal eller uttrangerad utrustning till tillverkaren för kassering utan kostnad för användaren.

Obs! Om du ska återlämna utrustning för återvinning ska du kontakta tillverkaren av utrustningen eller återförsäljaren för att få anvisningar om hur du återlämnar kasserad utrustning för att den ska bortskaffas på rätt sätt.

Viktigt dokument. Spara tillsammans med dina produktbeskrivningar.

SPANISH

A partir del 12 de agosto de 2005, los equipos eléctricos que lleven este símbolo no deberán ser desechados en los puntos limpios europeos. De conformidad con las normativas europeas locales y nacionales (Directiva de la UE 2002/96/EC), a partir de esa fecha, los usuarios europeos de equipos eléctricos deberán devolver los equipos usados u obsoletos al fabricante de los mismos para su reciclado, sin coste alguno para el usuario.

Nota: *Sírvase ponerse en contacto con el fabricante o proveedor de los equipos para solicitar instrucciones sobre cómo devolver los equipos obsoletos para su correcto reciclado.*

Documento importante. Guardar junto con los registros de los equipos.

DUTCH

Elektrische apparatuur die is voorzien van dit symbool mag na 12 augustus 2005 niet meer worden afgevoerd naar Europese openbare afvalsystemen. Conform Europese lokale en nationale wetgeving (EU-richtlijn 2002/96/EC) dienen gebruikers van elektrische apparaten voortaan hun oude of afgedankte apparatuur kosteloos voor recycling of vernietiging naar de producent terug te brengen.

Nota: *Als u apparatuur voor recycling terugbrengt, moet u contact opnemen met de producent of leverancier voor instructies voor het terugbrengen van de afgedankte apparatuur voor een juiste verwerking.*

Belangrijk document. Bewaar het bij de productpapieren.

POLISH

Sprzęt elektryczny oznaczony takim symbolem nie może być likwidowany w europejskich systemach utylizacji po dniu 12 sierpnia 2005. Zgodnie z europejskimi, lokalnymi i państwowymi przepisami prawa (Dyrektywa Unii Europejskiej 2002/96/EC), użytkownicy sprzętu elektrycznego w Europie muszą obecnie przekazywać Producentowi stary sprzęt lub sprzęt po okresie użytkowania do bezpłatnej utylizacji.

Uwaga: *Aby przekazać sprzęt do recyklingu, należy zwrócić się do producenta lub dostawcy sprzętu w celu uzyskania instrukcji dotyczących procedur przekazywania do utylizacji sprzętu po okresie użytkowania.*

Ważny dokument. Zachować z dokumentacją produktu.

PORTUGUESE

Qualquer equipamento eléctrico que ostente este símbolo não poderá ser eliminado através dos sistemas públicos europeus de tratamento de resíduos sólidos a partir de 12 de Agosto de 2005. De acordo com as normas locais e europeias (Directiva Europeia 2002/96/EC), os utilizadores europeus de equipamentos eléctricos deverão agora devolver os seus equipamentos velhos ou em fim de vida ao produtor para o respectivo tratamento sem quaisquer custos para o utilizador.

Nota: *No que toca à devolução para reciclagem, por favor, contacte o produtor ou fornecedor do equipamento para instruções de devolução de equipamento em fim de vida para a sua correcta eliminação.*

Documento importante. Mantenha junto dos registos do produto.

Appendix D: Glossary

Several of the terms used throughout this Operator Manual have specific meaning within high-purity water applications.

Conductivity	A measure of the ability to conduct current through water. Conductivity, very low with high-purity deionized water, is the reciprocal of resistivity and is measured in microsiemens per centimeter ($\mu\text{S}/\text{cm}$).
High-Purity Water (HPW)	A term that differentiates between simple deionized water and the purer water required for more critical processes. High-purity implies water that is low in potential contaminants such as ions, microorganisms, organics and particles.
Megohm ($\text{M}\Omega$)	A measurement of 1,000,000 ohms.
Microsiemens (μS)	A unit of conductance in the metric system equivalent to one millionth of an ampere per volt ($1 \mu\text{S} = 1 \text{M}\Omega$).
Organic	Organic chemicals which include carbon atoms in complex molecules, but do not include carbonate (CO_2 , HCO_3 , CO_3) or cyanide (CN) related compounds. Oxygen is very common in organics and they almost always include hydrogen.
Oxidation	The loss of electrons by a chemical species, typically with oxygen. Organic carbon, for example, oxidizes to carbon dioxide and water.
Parts per billion (ppb)	A term used to report trace chemical analyses. It refers to the concentration of the element or compound present within one billion parts of water. One microgram per liter ($\mu\text{g}/\text{L}$) is equal to 1 ppb).
Resistivity	Resistance, measured in megohmcentimeters ($\text{M}\Omega\text{-cm}$), to the flow of electrical current through high-purity water. Resistivity is a means of continuously measuring the purity of the water and is the reciprocal of conductivity.
Temperature Compensation	Conductivity and resistivity of electric current in water depend on the temperature of the water. The lower the temperature, the lower the conductivity and the higher the resistivity. Conductivity and resistivity measurements typically are normalized to 25°C . In other words, they reflect the values they would report at a sample temperature of 25°C using a model based on sodium chloride in water.
Total Organic Carbon (TOC)	A measurement of the organics present in water based on its carbon content. High-purity water measures TOC in parts per billion (ppb). This term is used interchangeably with total <i>oxidizable carbon</i> .

Annex

Tables and illustrations

Fig. 1-1	TOC600 Analyzer Components	14
Table 2-1	Preparatory and Installation Issues	15
Fig. 2-1	Passive Terminator	17
Fig. 2-2	C80 Logon Screen	17
Fig. 2-3	Sensor Setup Selections	18
Fig. 2-4	System Time Submenu	18
Fig. 2-5	System Time Screen	18
Fig. 2-6	Controller Edit Selections	19
Fig. 2-7	Current Day Display	19
Fig. 2-8	Current Time Display	19
Fig. 2-9	Sensor Setup Selections	19
Fig. 2-10	Analysis Setup Selections	20
Fig. 2-11	Sensor Name Screen	20
Fig. 2-12	Controller Edit Mode	20
Fig. 2-13	Change Character	21
Fig. 2-14	Sensor Name Change	21
Fig. 2-15	Controller Mounting Dimensions	22
Fig. 2-16	TOC600 Analyzer Mounting Template	23
Fig. 2-17	High-Purity Water System	24
Fig. 2-18	Three-Way Bypass Valve Installation	25
Fig. 2-19	TOC600 Analyzer	26
Fig. 2-20	TOC600 Analyzer Water I/O Connections	27
Fig. 2-21	TOC600 Analyzer: Bottom View	29
Fig. 2-22	Connector Block	30
Table 2-2	Isolated I/O Connections	31
Table 2-3	Non-Isolated I/O Connections	31
Fig. 2-23	Anet (maximum 8 Analyzers)	32
Fig. 2-24	Manual Menu	33
Fig. 2-25	Modes Menu	33
Fig. 2-26	Special Modes Menu	33
Fig. 2-27	Print Menu	34
Fig. 2-28	Printouts Menu	34
Fig. 3-1	ID to Serial Number Cross-Reference Screen	36
Fig. 3-2	Sensor Setup Selections	36
Fig. 3-3	Controller Edit Mode	36
Fig. 3-4	Controller Address Screen	37
Table 3-1	Potential Anet Configurations	38
Fig. 3-5	Anet Communications Connections	39
Fig. 3-6	Sensor NET Port Connections	40
Fig. 4-1	C80 Controller Display	41
Fig. 4-2	C80 Setup Selections	43
Fig. 4-3	C80 Setup Submenu	43

Fig. 4-4	C80 Contrast Adjustment Screen.....	44
Fig. 4-5	Access Denied Message.....	44
Fig. 4-6	Single Channel View.....	45
Fig. 4-7	Multichannel View.....	46
Fig. 4-8	Channel Display.....	47
Fig. 4-9	Checksum Display.....	48
Table 5-1	Factory Defaults.....	49
Fig. 5-1	Factory Default Selection.....	51
Fig. 5-2	Factory Defaults Screen.....	51
Fig. 5-3	Setting Supervisor Password Screen.....	52
Fig. 5-4	Enter Supervisor ID.....	53
Fig. 5-5	Enter Supervisor Password.....	53
Fig. 5-6	Setting Operator Password Screen.....	54
Fig. 5-7	Display Units Menu.....	55
Fig. 5-8	Display Units Screen.....	55
Fig. 5-9	Uncompensated Conductivity Display.....	56
Fig. 5-10	Auto TOC Mode Selection.....	57
Fig. 5-11	Analysis Time Line.....	58
Fig. 5-12	Oxidation State.....	59
Fig. 5-13	P1-Type Oxidation Curve.....	59
Fig. 5-14	P2-Type Oxidation Curve.....	60
Fig. 5-15	P3-Type Oxidation Curve.....	60
Fig. 5-16	Sample Time.....	62
Fig. 5-17	Sample Time Screen.....	63
Fig. 5-18	Sample Time Displayed.....	63
Fig. 5-19	Change Sample Time.....	63
Fig. 5-20	Cycle Time Screen.....	64
Fig. 5-21	Cycle Time Displayed.....	65
Fig. 5-22	Change Cycle Time.....	65
Fig. 5-23	Sampling Mode Screen.....	66
Fig. 5-24	Cycle Modes Screen.....	67
Fig. 5-25	Sample TOC Printout.....	68
Table 5-2	TOC Printout Information.....	68
Fig. 5-26	TOC Print.....	69
Fig. 5-27	TOC Print Format.....	70
Fig. 5-28	Paper Saver Print Screen.....	70
Fig. 5-29	Selecting the Purge Mode.....	71
Table 5-3	Purge Printout Reports.....	72
Fig. 5-30	Purge Printout.....	72
Fig. 5-31	Purge Print Outputs.....	73
Fig. 5-32	Timed Purge Print Screen.....	74
Fig. 5-33	Timed Purge Print.....	74
Fig. 5-34	Paper Saver Print Screen.....	75
Fig. 5-35	Paper Saver Print.....	75
Fig. 5-36	Header Print.....	76
Fig. 5-37	TOC Print Format.....	76

Fig. 5-38	Manual Sample State	77
Fig. 5-39	Sample Time Interval	77
Fig. 5-40	Manual Oxidize State	78
Fig. 6-1	Calibration Standard Criteria	81
Fig. 6-2	Calibration Data.....	82
Fig. 6-3	TOC Calibration Results.....	83
Fig. 6-4	Sample TOC Calibration Printout.....	84
Fig. 6-5	Validation Standard Criteria	85
Fig. 6-6	Analysis Replicates	86
Fig. 6-7	Blank Average	86
Fig. 6-8	Analysis Results	86
Fig. 6-9	TOC Validation Results	87
Fig. 6-10	Sample Single-Point TOC Validation Printout.....	88
Fig. 6-11	Sample Three-Point TOC Validation Printout.....	88
Fig. 6-12	Calibrate Menu	89
Fig. 6-13	Conductivity Calibration Results.....	90
Fig. 6-14	Sample Conductivity Calibration Printout.....	91
Fig. 6-15	Certificate of Analysis Values.....	92
Fig. 6-16	Certificate of Analysis Displayed.....	92
Fig. 6-17	Analysis Replicates	93
Fig. 6-18	System Suitability Results	93
Fig. 6-19	Adjust Alarm Limit	94
Fig. 6-20	Sample System Suitability Printout	95
Fig. 6-21	Show TOC Cal	96
Fig. 6-22	Last Accepted.....	96
Fig. 6-23	Data History Screen	96
Fig. 6-24	Data History Print	96
Fig. 7-1	Alarm Setup Menu.....	97
Fig. 7-2	Sensor Setup Menu.....	98
Fig. 7-3	Analysis Setup Menu.....	98
Fig. 7-4	More Setup Menu.....	98
Fig. 7-5	Alarm Setup Menu.....	98
Fig. 7-6	Change Alarm Limit.....	99
Fig. 7-7	TOC Alarm Limit Screen	99
Fig. 7-8	Alarm Limit Changed.....	100
Fig. 7-9	Beeper Setup Menu	100
Fig. 7-10	C80 Alarm Beeper Screen	101
Fig. 7-11	Reported Sensor Alarm.....	102
Table 7-1	Temperature-based Conductivity Limits.....	103
Fig. 7-12	Alarm Setup Menu.....	104
Fig. 7-13	Uncompensated Conductivity Alarm	105
Fig. 7-14	Acknowledged Sensor Alarm	106
Fig. 7-15	Alarm Reporting	107
Fig. 8-1	External Printer Wiring	109
Table 8-1	Preset DIP Switches.....	110
Fig. 8-2	Log Screen.....	112

Fig. 8-3	Print Range	112
Fig. 8-4	Sample Log Printout.....	113
Fig. 8-5	Log Setup Screen.....	114
Fig. 8-6	Sensor Print.....	114
Fig. 8-7	Printouts Screen.....	115
Fig. 8-8	Setup Printout.....	117
Fig. 8-9	Factory Printout.....	118
Table 9-1	Conversion Resistors	119
Fig. 9-1	Current Output Wiring	120
Fig. 9-2	Voltage Output Wiring	120
Fig. 9-3	Setup Menu.....	121
Fig. 9-4	Sensor Setup Menu.....	121
Fig. 9-5	Analog Setup.....	121
Fig. 9-6	DAC Range Menu	122
Fig. 9-7	DAC Range Menu	122
Fig. 9-8	mA Range Screen.....	123
Fig. 9-9	DAC Range Menu	123
Fig. 9-10	Zero-Scale TOC Screen.....	124
Fig. 9-11	Zero-Scale TOC Menu	124
Fig. 9-12	Zero-Scale TOC Data.....	125
Fig. 9-13	Full-Scale TOC Screen	125
Fig. 9-14	Full-Scale TOC Data	126
Fig. 9-15	DAC Error Output Menu.....	126
Fig. 9-16	DAC Error Output Screen.....	127
Fig. 9-17	DAC Calibration Output Screen	127
Fig. 9-18	External DAC Wiring	129
Fig. 9-19	Setup Menu.....	130
Fig. 9-20	DAC Error Output Menu.....	130
Fig. 9-21	External DAC Module Screen	131
Fig. 9-22	DAC mA Range Screen	132
Fig. 9-23	DAC mA Range Menu.....	132
Fig. 9-24	DAC Zero-Scale Menu	133
Fig. 9-25	Zero-Scale Uncompensated Conductivity Display	133
Fig. 9-26	Zero-Scale TOC Data.....	134
Fig. 9-27	Full-Scale Uncompensated Conductivity Display.....	134
Fig. 9-28	Full-Scale TOC Data	134
Fig. 9-29	DAC Zero-Scale Menu	135
Fig. 9-30	Zero-Scale Temperature Screen.....	135
Fig. 9-31	Zero-Scale Temp Data	135
Fig. 9-32	Full-Scale Temperature Screen	136
Fig. 9-33	Full-Scale Temp Data.....	136
Table 10-1	Digital Inputs.....	138
Fig. 10-1	Typical Digital Input Wiring.....	138
Fig. 10-2	Manual Submenu	139
Fig. 10-3	Modes Menu.....	139
Fig. 10-4	Special Modes Screen	139

<i>Fig. 10-5</i>	<i>Typical Digital Output Wiring</i>	140
<i>Fig. 11-1</i>	<i>Bias Connections</i>	142
<i>Fig. 12-1</i>	<i>Serial Wiring</i>	145
Table 12-1	Notations for Command Arguments.....	146
Table 12-2	Mode Set Commands.....	146
Table 12-3	Parameter Set Commands.....	147
Table 12-4	Data Read Commands.....	149
Table 12-5	Log Commands.....	150
Table 12-6	Data History Command.....	150
<i>Fig. 13-1</i>	<i>Manual Menu</i>	152
<i>Fig. 13-2</i>	<i>Special Modes Menu</i>	152
<i>Fig. 13-3</i>	<i>Selecting the Self-Clean Mode</i>	153
<i>Fig. 13-4</i>	<i>Location of Hex Bolts</i>	154
<i>Fig. 13-5</i>	<i>TOC600 Analyzer UV Lamp Assembly</i>	155
<i>Fig. 13-6</i>	<i>TOC600 Analyzer UV Lamp Replacement Diagram</i>	157
<i>Fig. 13-7</i>	<i>Loosening the UV Lamp Bracket</i>	158
<i>Fig. 13-8</i>	<i>Pulling the UV Lamp Connector Plug</i>	158
<i>Fig. 13-9</i>	<i>Inserting the New UV Lamp Assembly</i>	159
<i>Fig. 13-10</i>	<i>Aligning the Arrow with the Bracket Screw</i>	159
<i>Fig. 13-11</i>	<i>Inserting the UV Lamp Connector</i>	160
<i>Fig. 13-12</i>	<i>Resetting the Lamp Counter</i>	161
<i>Fig. 13-13</i>	<i>TOC600 Analyzer Air Filters</i>	162
<i>Fig. 13-14</i>	<i>Inline Filter Assembly</i>	163
<i>Fig. 13-15</i>	<i>Collar Position</i>	163
Table 14-1	Electromechanical Alarm Codes	166
Table 14-2	Analysis Alarm Codes	167
Table 14-3	Troubleshooting Electromechanical Alarms.....	168
<i>Fig. 14-1</i>	<i>Failure Identified</i>	169
Table 14-4	TOC600 Calibration Tests.....	170
<i>Fig. 14-2</i>	<i>Purging the TOC600 Measurement Cell</i>	172
<i>Fig. 14-3</i>	<i>Diagnostics Menu</i>	173
<i>Fig. 14-4</i>	<i>Electronics Diagnostic Screen</i>	173
Table 14-5	Electronics Menu Diagnostic Options.....	174
Table 14-6	Cell Menu Diagnostic Options.....	174
<i>Fig. 14-5</i>	<i>Valve Test Diagnostics Menu</i>	175
Table 14-7	I/O Menu Diagnostic Options	175
<i>Fig. 14-6</i>	<i>I/O Diagnostics Screen</i>	176
<i>Fig. 14-7</i>	<i>RS-232 Loopback Wiring</i>	176
<i>Fig. 14-8</i>	<i>Digital I/O Loopback Wiring</i>	177
<i>Fig. 14-9</i>	<i>DAC Output Test Screen</i>	178

Global Headquarters

6, route de Compois C.P. 212
CH-1222 Vesenaz, Geneva, Switzerland
Tel +41 22 855 91 00
Fax +41 22 855 91 99

Americas Headquarters

481 California Avenue
Grants Pass, Oregon 97526 USA
Tel 1 800 866 7889 / +1 541 472 6500
Fax +1 541 479 3057

www.hachultra.com

