



Agilent 7200B Series GC/Q-TOF

RESOLVE YOUR MOST CHALLENGING APPLICATIONS

The Measure of Confidence



禹重科技 ÜZONGLAB
成分分析仪器 | 表面测试仪器 | 样品前处理仪器



Agilent Technologies

THE AGILENT 7200B SERIES GC/Q-TOF

RESOLVE YOUR SEARCH FOR BOTH TARGETS AND UNKNOWNNS

Agilent 7200B Series GC/Q-TOF: expanding on the world's leading GC/Q-TOF

The Agilent 7200B GC/Q-TOF provides enhanced capabilities with:

- ▶ Electron Ionization (EI) and Chemical Ionization (CI) standard on all systems
- ▶ Extended mass range up to m/z 3000
- ▶ Mass accuracy of < 3 ppm RMS
- ▶ Backflush-ready system for improved GC functionality
- ▶ New software features and Accurate Mass Library tools
- ▶ GC/Q-TOF Pesticide Exact Mass Library



The 7200B Series GC/Q-TOF system expands on the proven separation power of the Agilent 7890B GC and now includes a backflush-ready configuration with every system. The 7200B Q-TOF also has enhanced features such as extended mass range, which can be particularly useful for analysis of high mass compounds with the Thermal Separation Probe.



Agilent 5977E Series GC/MSD
Outstanding value for routine analysis



Agilent 5977A Series GC/MSD
Industry standard for single quadrupole sensitivity, stability, and spectral fidelity



Agilent 5975T LTM GC/MSD
World's first transportable GC/MSD



Agilent 7000C Triple Quadrupole GC/MS
Proven choice for today's regulatory methods



Agilent 7010 Triple Quadrupole GC/MS
Setting new standards for EI performance

Your first choice for exceptional qualitative *and* quantitative analysis

The Agilent 7200B Series GC/Q-TOF combines the sought-after features of our flagship GC/MS systems with the following advanced capabilities:

High resolution and mass accuracy

Low-ppm mass accuracy – combined with 15x to 50x greater resolution than a single quadrupole MS – gives you the power to analyze target, non-target, and unknown compounds with much greater reliability.

Extended mass range capabilities

Extended mass range allows you to analyze high mass compounds, particularly beneficial for use with Thermal Separation Probes.

Low detection limits

A full-spectrum with sensitivity greater than that of quadrupole MS lets you capture accurate mass spectra at low pg on-column for most compounds.

Unparalleled MS/MS selectivity

The detection selectivity of high-resolution MS/MS dramatically surpasses other MS/MS analyzers. Moreover, accurate mass product ion spectra help confirm targets and non-targets as well as elucidate unknown compounds.

Simplify your analysis of accurate mass MS and MS/MS files

Agilent MassHunter software provides valuable tools for identification, quantitation, and confirmation.

- Find compounds in complex samples by applying deconvolution optimized for EI or CI data.
- The combination of library search results and calculated formulas for molecular and fragment ions simplifies compound identification.
- Perform multivariate statistical analysis on several data files using Mass Profiler Professional – a mass spectrometry-centric chemometrics program.

Accurate mass information lets you qualitatively and quantitatively recognize compounds with maximum confidence.

TIME-TESTED DESIGN WITH LEADING-EDGE ENHANCEMENTS



Agilent 7890B GC

Agilent's flexible 7890B GC is designed for MS analysis to optimize system performance.



High-sensitivity extractor ion source

Programmable up to 350 °C for robust compatibility with complex matrices.



Hot quartz monolithic hyperbolic quadrupole

Can be heated to 200 °C – without resolution or sensitivity loss – to eliminate contamination from high-temperature GC peaks.

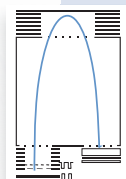

Stable, high-performance TOF technology

Agilent's orthogonal TOF technologies deliver consistent performance for thousands of LC/TOF, LC/Q-TOF and GC/Q-TOF systems.

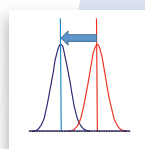

Internal reference mass (IRM) correction

When desired, an IRM compound can be introduced into the source for maximum mass accuracy.



Removable ion source

Computer control of both the transfer line and vacuum interlock position ensures trouble-free ion source replacement in about 30 minutes.

To learn more about the capabilities of the Agilent 7200 Series GC/Q-TOF, visit agilent.com/chem/GCMS_QTOF

Results *prove* how GC/Q-TOF technology makes exceptional qualitative and quantitative analysis *real* – and *easy*

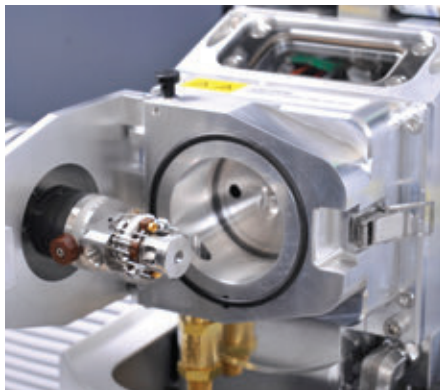

User-friendly videos and software guide you through all the necessary steps for source removal and installation – making the process safe and error free.

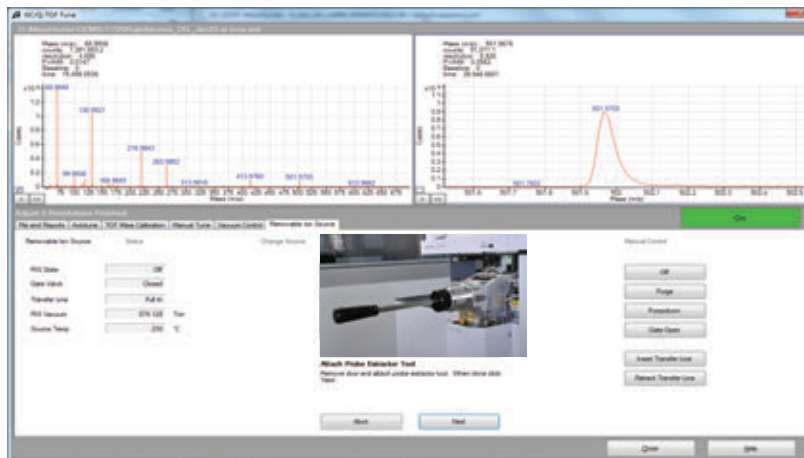

Removable Ion Source (RIS) lets you change the complete ion source – including repeller, ion volume, extraction lens, and dual filaments – in about 30 minutes without venting.

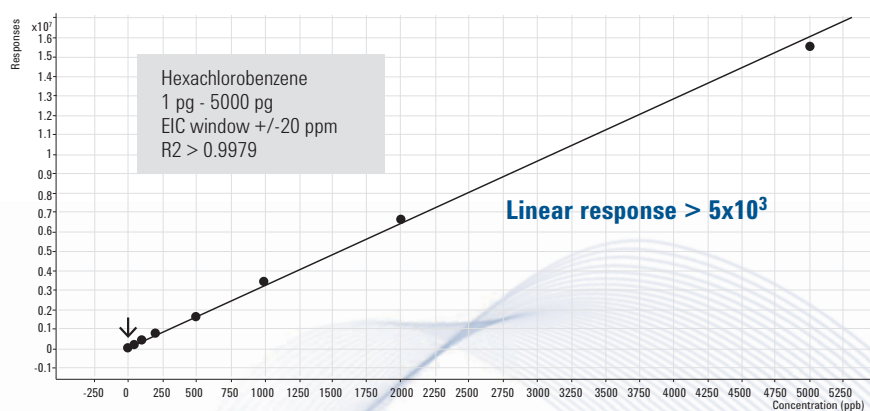

Analog-to-digital (ADC) Detector: The 4 GHz sampling rate of ADC electronics enables exceptional linearity in high-resolution mode. For an even wider linear range, dual-gain amplifiers simultaneously process detector signals through both low-gain and high-gain channels.

pg on-column	mass error, ppm	
	2-formyl thiophene	2-acetyl thiazole
1	-3.57	-0.79
2	-4.46	-0.79
5	-2.68	-0.79
10	-2.68	0.79
20	-2.68	0.00
50	-0.89	1.57
100	0.00	1.57
200	-1.79	1.57
500	2.68	1.57
1000	1.79	-1.57
Average	-1.43	0.31

Internal Reference Mass (IRM) is a proprietary system that locks the mass axis for each spectra to a calibrant compound. IRM ensures low-ppm mass accuracy under the most complex chromatographic conditions.

Excellent clarity and mass accuracy enable analysis of targets, non-targets, and unknowns

With its low-ppm mass accuracy and high resolving power, the Agilent 7200B Series GC/Q-TOF can help you reduce uncertainty, minimize false positives, confirm database search results, and generate molecular formulas for unknowns.



Fast, trouble-free setup

Our automated acquisition software guides you through each step of the tuning and mass calibration process for precise high resolution and accurate mass operation.

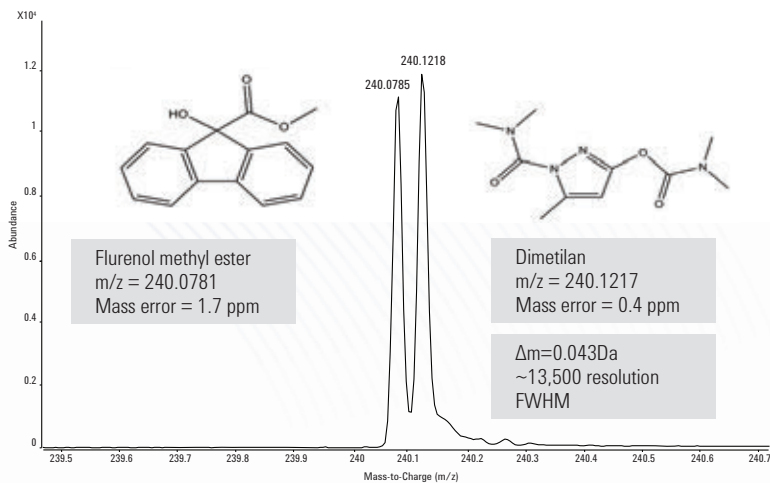

Superior resolving power is essential for confident analyte identification

Resolution of 13,500 (FWHM) easily resolves two compounds with nominal masses of 240 Da, whose exact masses differ by only 0.0436 Da.

Superior resolving power is indispensable in confidently identifying analytes in complex matrices.

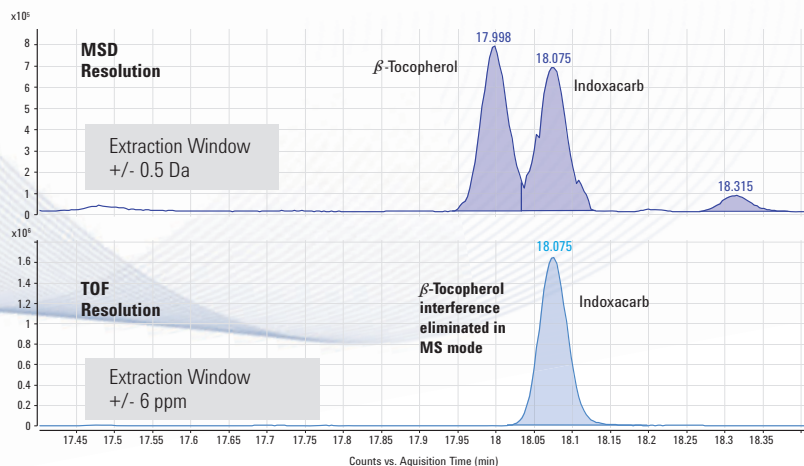

Accurate mass allows for efficient elimination of matrix interferences

Using an extraction window of +/- 6 ppm, the fragment ion of the target analyte, Indoxacarb (150.01195 Da), can easily be separated from the matrix interference ion of beta-Tocopherol (150.06839 Da). This facilitates reliable quantitative analysis.

When more selectivity is needed, MS/MS with accurate mass can help separate target analytes and matrix interferences further.

To learn more about the capabilities of the Agilent 7200 Series GC/Q-TOF, visit agilent.com/chem/GCMS_QTOF

Perform unambiguous structural elucidation and target confirmation

The identity of target and unknown compounds can be confirmed using a variety of techniques:

- Conducting an EI spectra library search
- Determining the PCI molecular ion
- Performing MS/MS dissociation of multiple precursor ions to document fragmentation pathways – an Agilent exclusive
- Calculating molecular formulas for all ions from accurate mass data

For very complex separations, such as the α -Cubebene example at right, MS/MS selectivity also generates a simplified spectrum to facilitate structure elucidation.

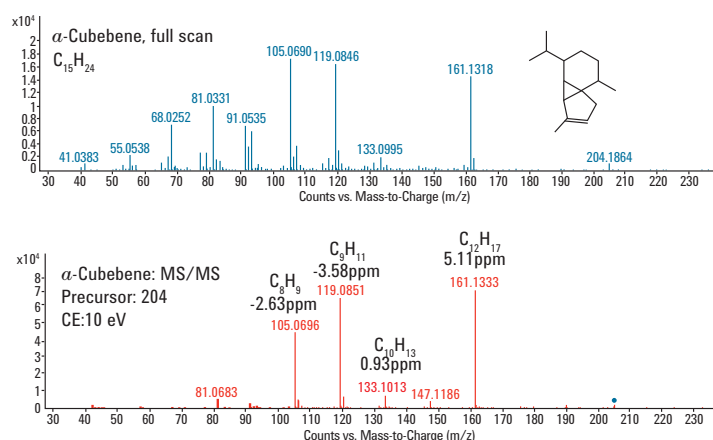

List of hits after deconvolution and library searching

TIC and component chromatogram for hits

TIC and extracted ions of α -Lindane

Deconvoluted spectrum of α -Lindane

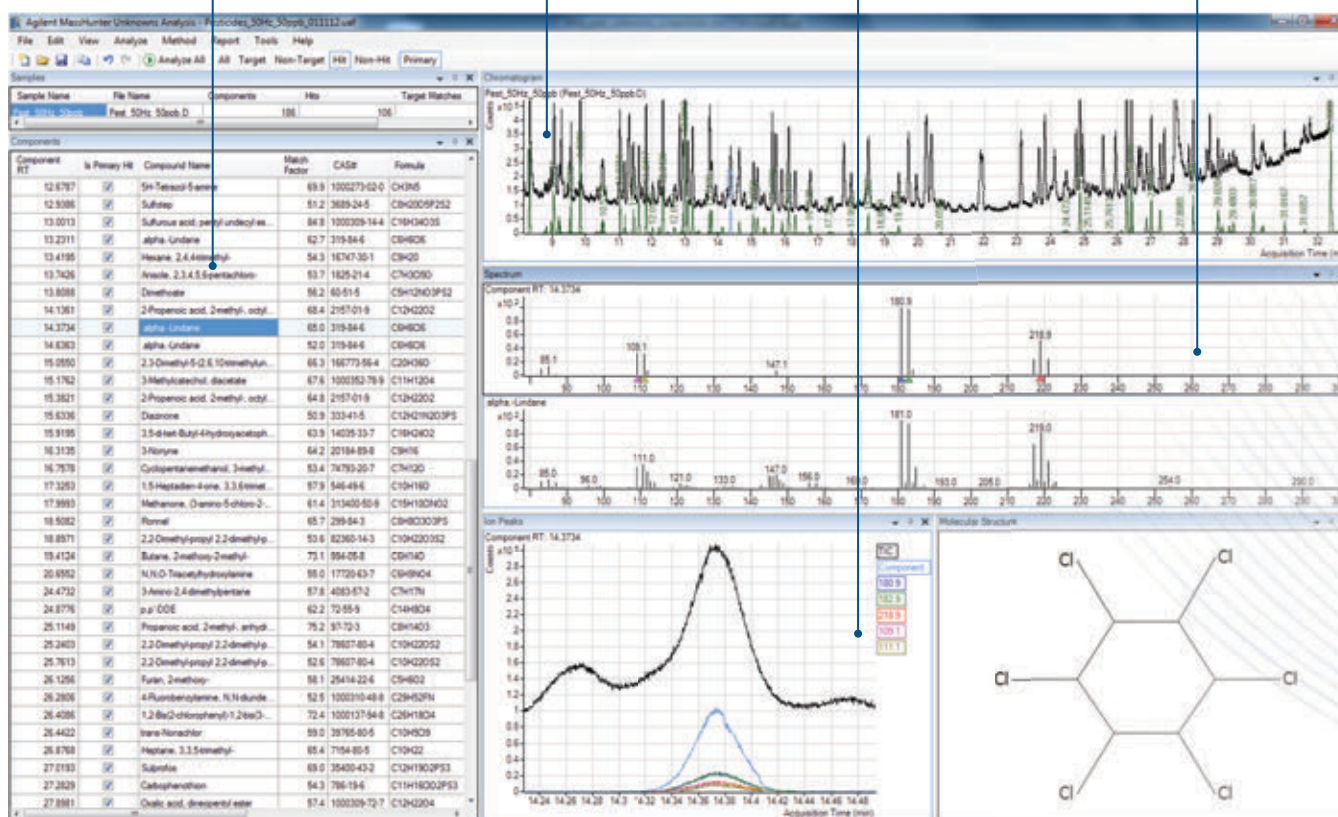

High-speed spectral acquisition is another fundamental advantage of TOF MS. Rates as fast as 50 Hz allow you to efficiently resolve a substantial number of components by chromatographic deconvolution with MassHunter's Unknowns Analysis tool.

NEW 7200B GC/Q-TOF

Raise your analytical performance to its highest level

The **Agilent 7200B GC/Q-TOF** provides new capabilities and enhanced performance, including an improved mass accuracy specification of less than 3 ppm and an extended mass range – an enhancement that is particularly beneficial when coupled to a Thermal Separation Probe (TSP) or Direct Insertion Probe (DIP).

The Agilent GC/Q-TOF is the best choice for helping you solve your most challenging problems.

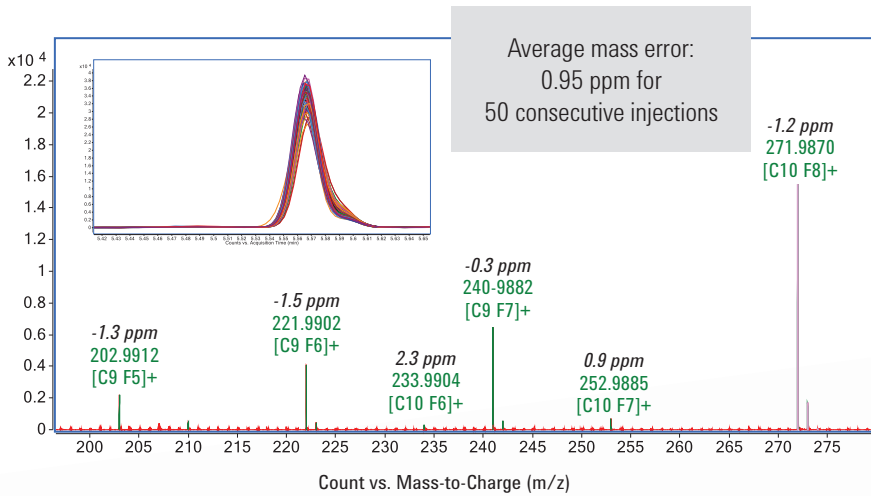

Excellent – and stable – mass accuracy

Here, octafluoronaphthalene (OFN) was repeatedly injected (50x) over a course of 5 hours. The peak overlay (inset) confirms the stability of the 7200B GC/Q-TOF, while the mass spectrum (bottom) demonstrates excellent mass accuracy. Average mass error for the 50 injections was 0.95 ppm.

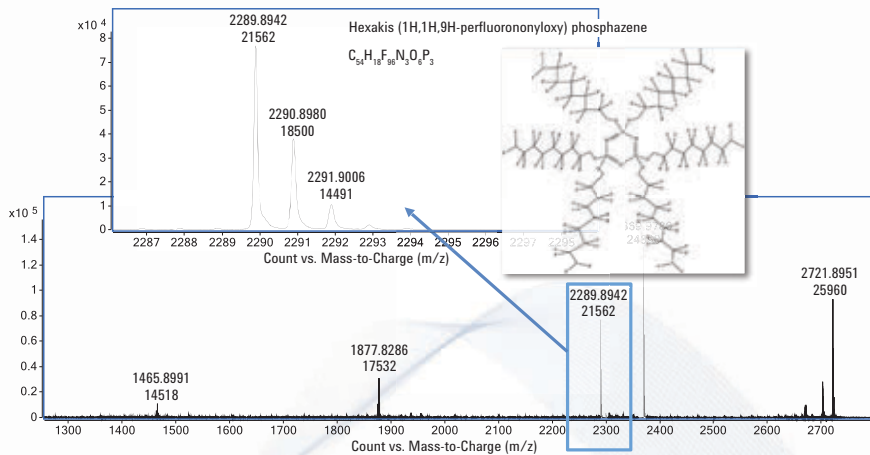

Extended mass range

Analysis of Hexakis (1H,1H, 9H-perfluorononyloxy) phosphazene with mass peaks out to m/z 2722. The top value illustrates mass-to-charge (m/z), while the bottom value shows mass resolution. A close-up of the m/z 2290 peak – showing isotopic peaks – is also highlighted (inset).

To learn more about the latest enhancements to the Agilent 7200 Series GC/Q-TOF, visit agilent.com/chem/GCMS_QTOF

PROVEN TECHNOLOGIES COMBINED WITH NEW – AND UNIQUE – FEATURES

DUAL-STAGE ION MIRROR

provides second-order time focusing for high mass resolution.

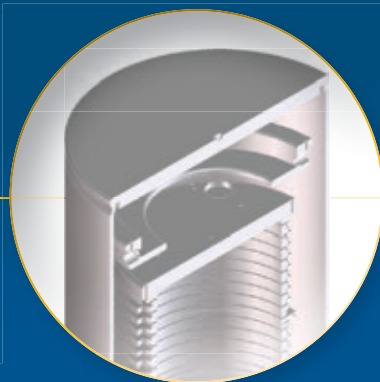

HEXAPOLE COLLISION CELL

accelerates ions through the cell, enabling faster generation of high-quality MS/MS spectra *without cross-talk*.

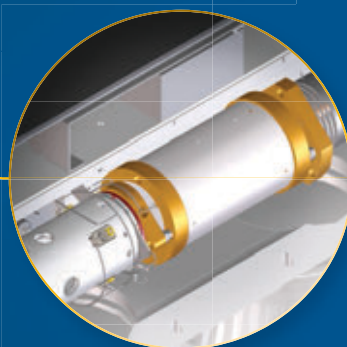

4 GHz ADC ELECTRONICS

enable a high sampling rate (32 Gbit/sec), ensuring high resolution, mass accuracy, and sensitivity.

HOT, QUARTZ, MONOLITHIC QUADRUPOLE ANALYZER

is performance-proven in over 30,000 Agilent GC/MS systems.

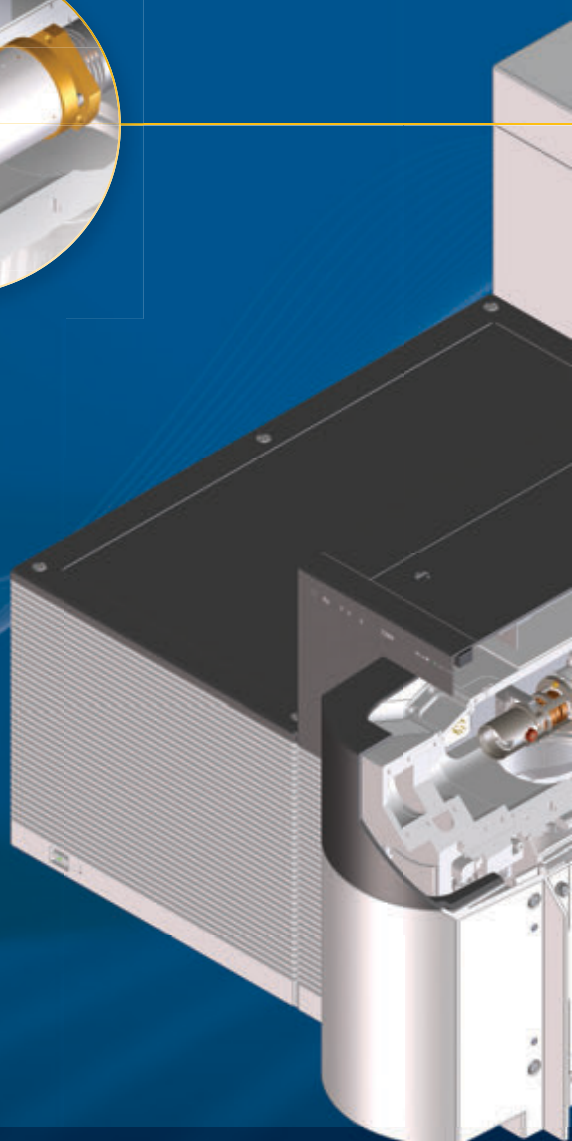
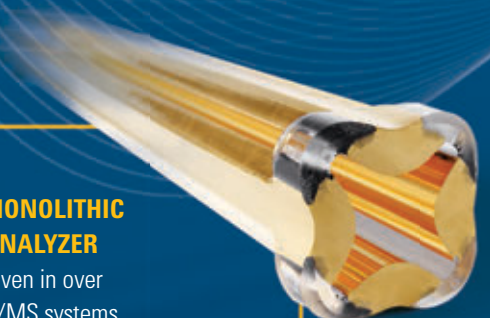

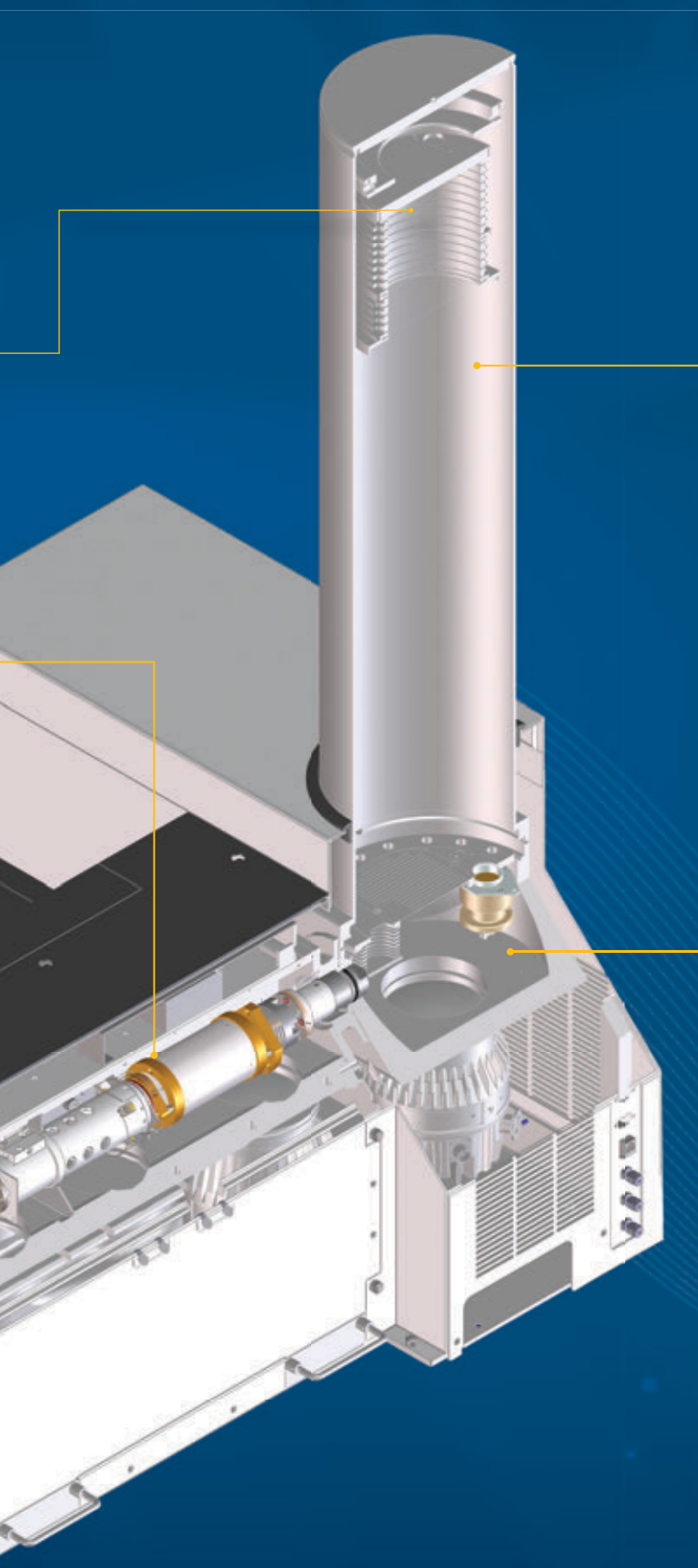

PROPRIETARY INVAR FLIGHT TUBE

sealed in a vacuum-insulated shell, maintains 24/7 mass accuracy by eliminating temperature-related thermal mass drift.

HYBRID CHANNEL PLATE PHOTOMULTIPLIER ION DETECTOR

delivers single ion detection sensitivity, excellent time resolution, and a large dynamic range.

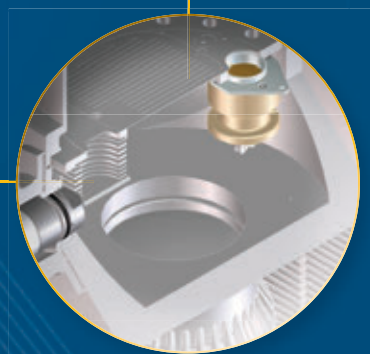

THREE TURBOMOLECULAR PUMPS

including two split flow pumps and one single stage pump for the source and quadrupole analyzer, create an optimal vacuum for every region of the analyzer assembly.

FOOD AND ENVIRONMENTAL APPLICATIONS

SCREEN AND IDENTIFY CONTAMINANTS IN CHALLENGING MATRICES

Conventional multi-target pesticide screening methods are based upon triple quadrupole technology. However, these methods are limited to target compounds, and do not allow a retrospective analysis of collected data.

Using Quadrupole Time-of-Flight (Q-TOF) technology for pesticides screening allows you to:

- Screen for a virtually unlimited number of pesticides in a variety of matrices
- Refer back to your data anytime, *without reruns*, to investigate samples for both target and non-target compounds
- Analyze your samples for unknown compounds or emerging contaminants

What's more, you can reliably identify pesticides – and simultaneously screen for a virtually unlimited number of compounds – by combining the **Agilent Exact Mass GC/Q-TOF Pesticide Library with MassHunter Qualitative Analysis Software.**

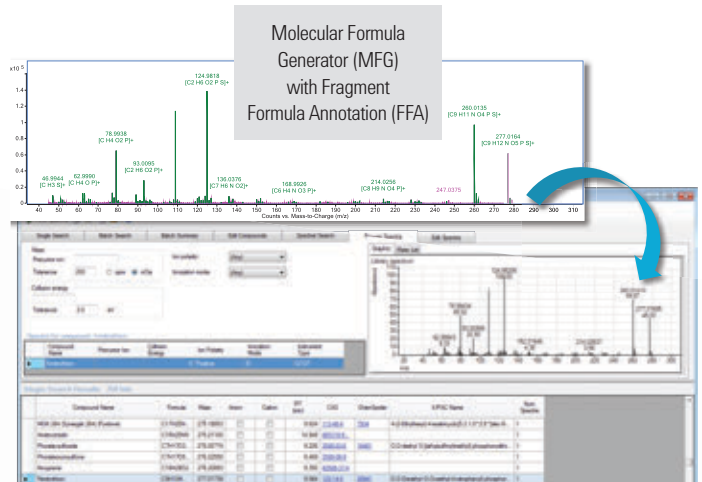

Easily create GC/Q-TOF Accurate Mass Libraries with software tools, such as Molecular Formula Generation with Fragment Formula Annotation, that produce formula-annotated, accurate-mass EI spectra. The EI fragments can then be *automatically converted* into the theoretical masses – and the corrected spectra sent to your Personal Compound Database & Library (PCDL).



Simplify your screening for target and unknown pesticides with All Ions software that allows you to adjust method settings based on specific applications or regulations. You can also quickly review results using the Compound Details View.

BUILDING PREDICTION MODELS FOR EXTRA VIRGIN OLIVE OIL

To construct a GC/Q-TOF data-based model that could predict whether an olive oil would pass the extra virgin sensory test, Mass Profiler Professional (MPP) software was used. The model utilized five specific compounds to predict the sensory test's outcome.

In addition to the EI spectral data, positive CI accurate mass spectra were necessary to confirm a molecular ion for the compounds used in the model.

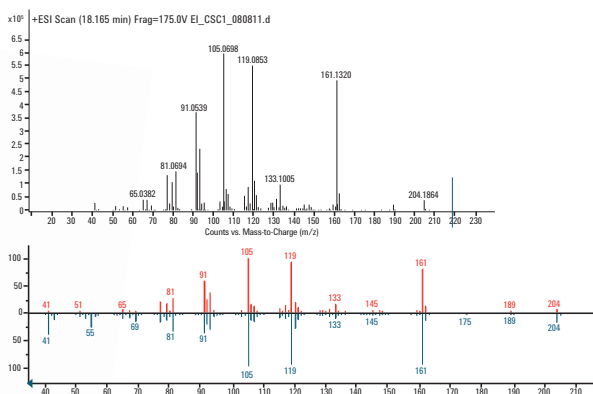

The Agilent 7200 Series GC/Q-TOF generates spectra that can be searched against the commercially available nominal mass EI spectral libraries.

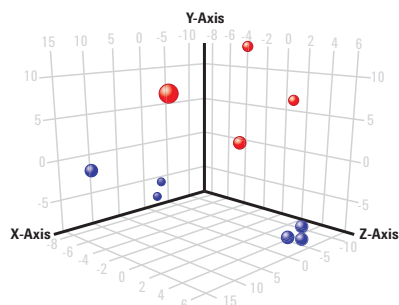

Principal Component Analysis (PCA) in MPP shows how the data clusters. The blue samples passed the sensory test, while the red samples failed.

Identifier	Grade	Training	Predicted(Class Pre-)	Confidence
PAC1-E-1: Ig2	F	None	[F, Training]	1.000
ESC2-E-1: Ig2	F	Training	[F, Training]	1.000
ESC1-E-1: Ig2	F	Training	[F, Training]	1.000
SAC1-E-1: Ig2	F	None	[F, Training]	1.000
RFC2-E-1: Ig2	F	None	[F, Training]	1.000
RG2-E-1: Ig2	F	None	[F, Training]	1.000
CYC1-E-1: Ig2	F	Training	[F, Training]	1.000
RG1-E-1: Ig2	F	Training	[F, Training]	1.000
EFC1-E-1: Ig2	F	None	[F, Training]	1.000
PSW2-E-1: Ig2	F	Training	[F, Training]	1.000

The MPP Prediction Model correctly predicted the pass/fail status of all samples. The samples not used for building the prediction model are listed with the training variable set as "None."

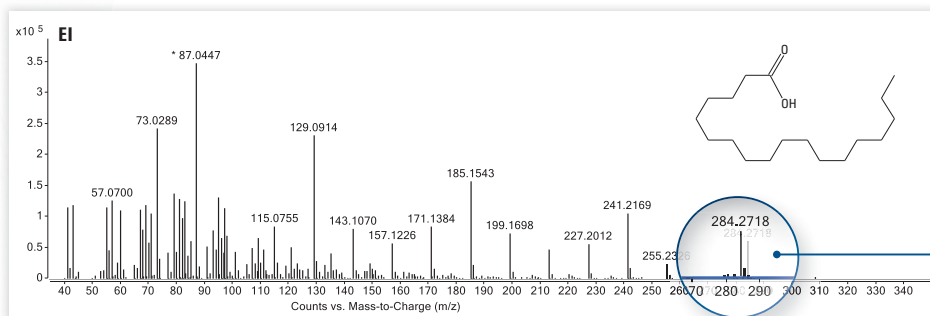

Positive CI spectral data provided additional accurate mass information for molecular ions. Adduct ions formed by the interaction of analytes with reagent gas can easily be detected, further helping to confirm the molecular ion.

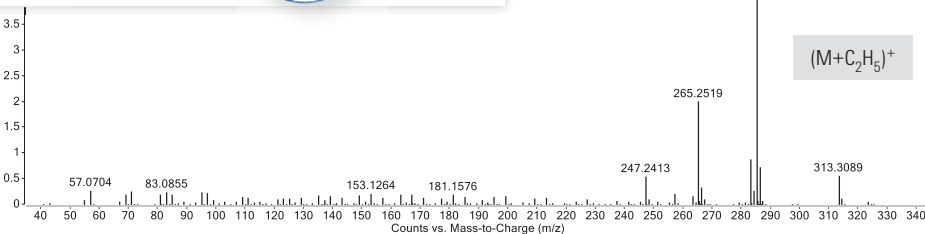

Reference:

Olive Oil Characterization using Agilent GC/Q-TOF MS and Mass Profiler Professional Software: Pub No. 5991-0106EN

To learn more about the capabilities of the Agilent 7200 Series GC/Q-TOF, visit agilent.com/chem/GCMS_QTOF

ANALYZE AND VISUALIZE CHANGES IN CELLULAR PATHWAYS

Using metabolomics workflows can be a powerful way to understand metabolic changes. Complex metabolomic studies will take advantage of full spectrum sensitivity and mass accuracy of GC/Q-TOF, as well as its MS/MS capability to assist in structural elucidation of unknown metabolites. The extended dynamic range of the Agilent 7200 Series GC/Q-TOF will allow for accurate and simultaneous quantification of a broad range of metabolites present in a cell.

In one simple experiment, Agilent's 7200 Series GC/Q-TOF provided the accurate mass information, excellent sensitivity in full spectrum mode,

and dynamic range essential for identifying and quantifying pathway intermediates of interest, thus unambiguously revealing the step in the biochemical pathway affected in a treated sample.

Mass Profiler Professional (MPP) was used for statistical data evaluation. The analysis included data filtering, baseline correction, and significance testing. The software's visualization tools were also indispensable for data interpretation.

Metabolites significantly changed in treated sample	Fold change in treated sample	
Squalene	2.5 (down)	Ergosterol biosynthesis pathway ↓
Lanosterol	1.7 (up)	
4,4-dimethyl-5 α -cholesta-8,24-dien-3 β -ol	1.4 (up)	
4α-carboxy-4β-methyl-5α-cholesta-8,24-dien-3β-ol	360.8 (up)	
Zymosterol	2.9 (down)	
Ergosterol	1.3 (down)	

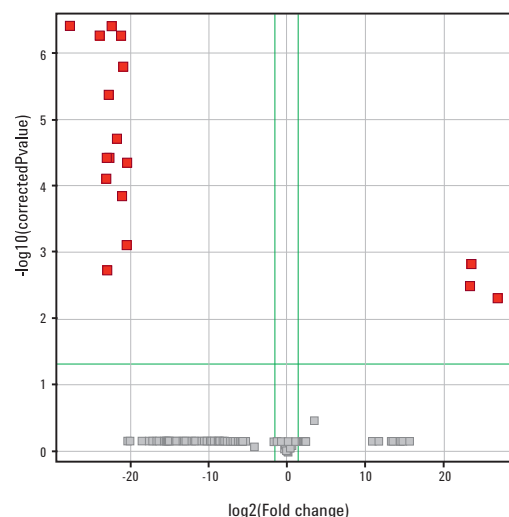

Significance analysis, performed in MPP, facilitates the identification of metabolites that change their levels under different conditions.

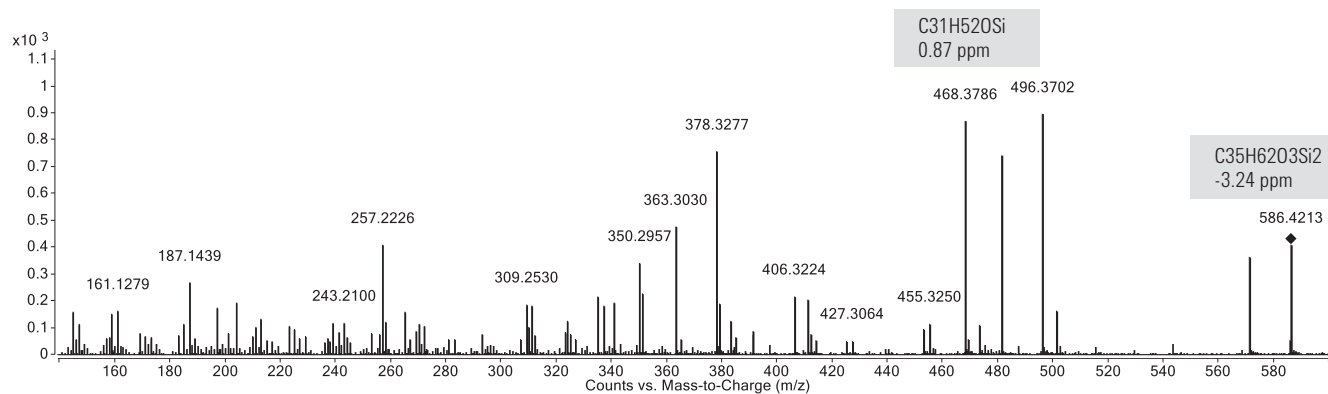

MS/MS with accurate mass product ion spectrum facilitates the structural elucidation of unknown compounds.

Confirm the proposed structure of a metabolite based on accurate mass product ion spectrum

Metabolomic studies often recognize a significant number of non-targets and unknown metabolites as potentially playing a critical role in biological interpretation of the data. Therefore, the structure of these important metabolites has to be confirmed or elucidated.

The pairing of Agilent's 7200 Series GC/Q-TOF with MassHunter Workstation software is ideal for this type of study.

Definitive structural elucidation:

MassHunter Qual Workstation's Mass Caliper tool can be used to elucidate neutral losses between any two m/z values from the spectrum.

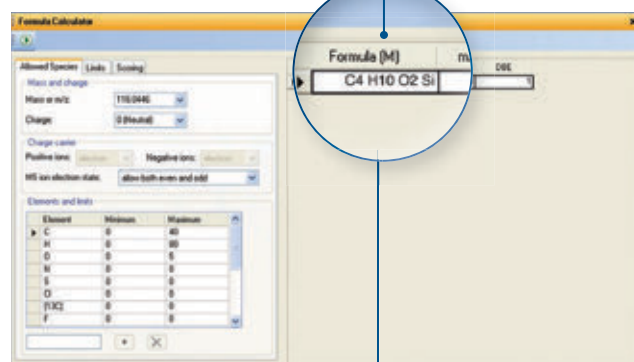
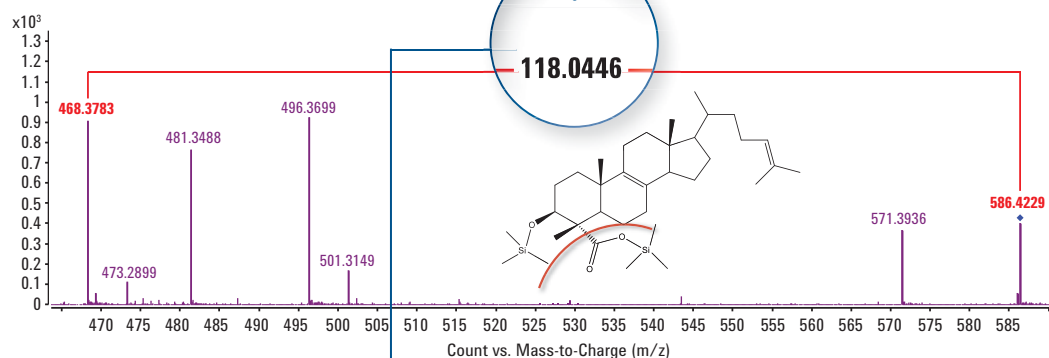

MassHunter Qual Formula Calculator uses the accurate mass data produced by Agilent's 7200 Series GC/Q-TOF to assign a formula to any ion fragment (or neutral loss) from the spectrum.

Acknowledgements:

This application is based upon work supported by Manhong Wu¹, Robert St. Onge², Sundari Suresh², Ronald Davis² and Gary Peltz¹

¹Department of Anesthesia, School of Medicine, Stanford University

²Biochemistry-Genome Center, Stanford University

Reference:

Metabolic Profiling of Yeast Sterols Using the Agilent 7200 Series GC/QTOF System: Pub No. 5991-0571EN

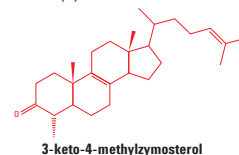
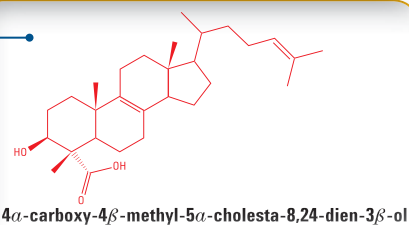
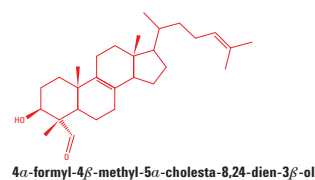

To learn more about the capabilities of the Agilent 7200 Series GC/Q-TOF, visit agilent.com/chem/GCMS_QTOF

COMBINE ACCURATE MASS AND MS/MS SPECTRA TO ELUCIDATE THE STRUCTURE OF UNKNOWN COMPOUNDS

Herbal extracts contain a large number of compounds that need to be identified; however, commercial EI spectral libraries do not always contain mass spectral data for compounds of interest. In these

instances, the accurate mass product ion spectra generated by the Agilent 7200 Series GC/Q-TOF can be invaluable for establishing relationships between fragment ions, thus assisting structure correlation.

Identification of unknowns in kava extract

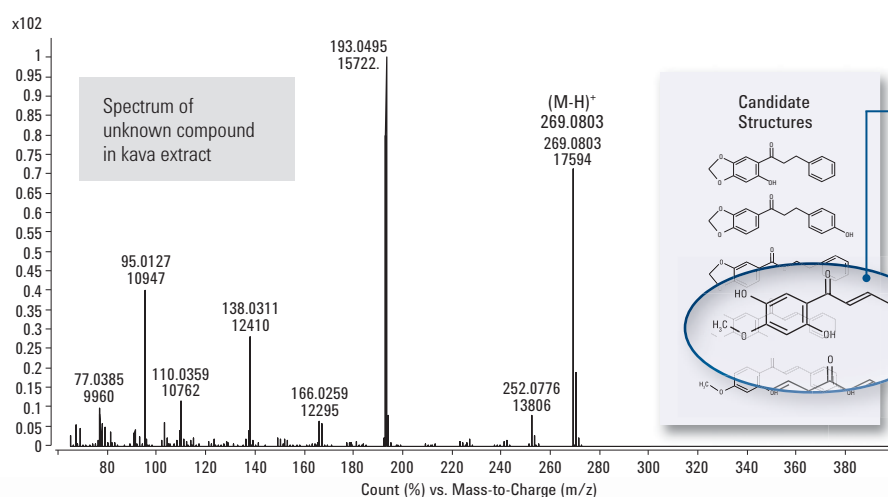

Of the 5 candidate structures, only one fits the losses identified by MS/MS experiments on multiple precursor ions.

MS/MS experimental measurements

	<i>m/z</i> (experimental)	Formula	Error (ppm)	Score
(M-H) ⁺	269.0803	C ₁₆ H ₁₃ O ₄	-1.99	80.7
(M-C ₆ H ₅) ⁺	193.0494	C ₁₀ H ₉ O ₄	-0.18	96.7
(M-CH=CH-C ₆ H ₅) ⁺	167.0334	C ₈ H ₇ O ₄	-2.9	N/A
(M-CH ₂ =CH-C ₆ H ₅) ⁺	166.0259	C ₈ H ₆ O ₄	-0.96	N/A
-CO	138.0311	C ₇ H ₆ O ₃	-0.33	98.1
-CO	110.0359	C ₆ H ₆ O ₂	-3.01	N/A
-CH ₃	95.0127	C ₅ H ₃ O ₂	-0.59	99.5

Accurate mass information of the product ion spectrum helps eliminate any ambiguity between different neutral losses that have the same nominal mass.

POINT OF ORIGIN ANALYSIS FOR ILLICIT DRUGS

Investigating the sale of heroin and other narcotics often involves identifying a specific group of criminals who mediate the drug trafficking activity within a particular country.

The Agilent 7200 Series GC/Q-TOF can be used to perform comparative studies of illegal drugs, which helps drug enforcement officers determine a common source of origin. You can also use accurate mass information to identify contaminants that yield additional clues to a drug's origin.

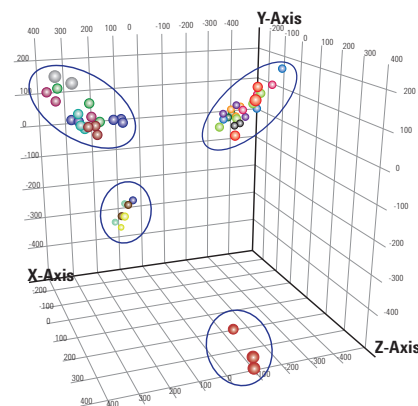

	[1] (Predicted)	[2] (Predicted)	Accuracy
(True) [1]	11	1	91.667
(True) [2]	0	12	100.000
Overall Accuracy			95.833

MPP tools – such as Principal Component Analysis and Hierarchical Cluster Analysis – allow you to visualize similarities and clustering between distinct groups.

Class prediction models can be used to classify unknown samples.

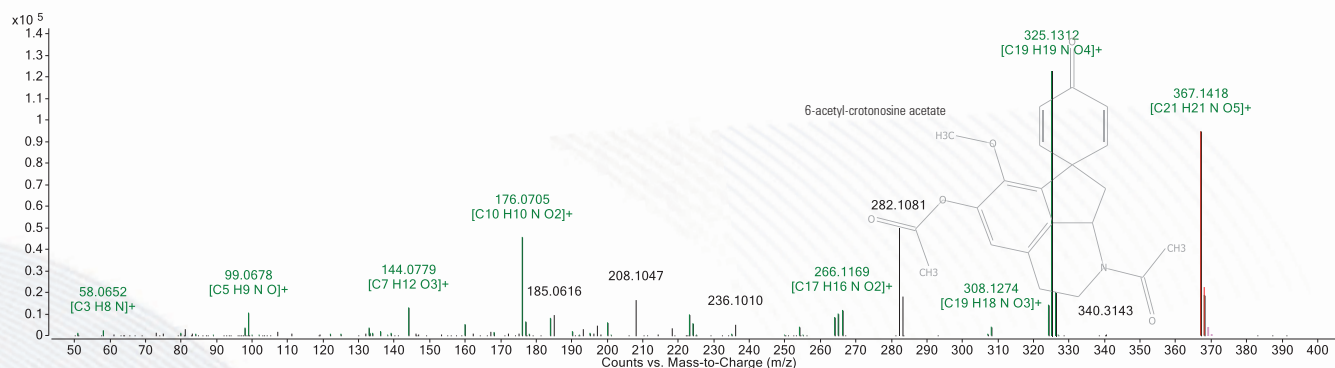

The spectrum annotation tools in MassHunter Qual let you rapidly confirm a tentatively identified compound using accurate mass information.

Reference:

Characterization and Classification of Heroin from
Illicit Drug Seizures Using the Agilent 7200 GC/Q-TOF:
Pub No. 5991-4369EN

To learn more about the capabilities of the Agilent 7200 Series GC/Q-TOF, visit agilent.com/chem/GCMS_QTOF

PROTECT THE HEALTH OF ATHLETES AND THE INTEGRITY OF THE GAME

Comprehensive doping control requires both targeted and non-targeted approaches – including in-depth studies of a drug's fragmentation pathways. You can identify drugs with similar structures (both metabolite and designer variants) by elucidating characteristic fragmentation ions.

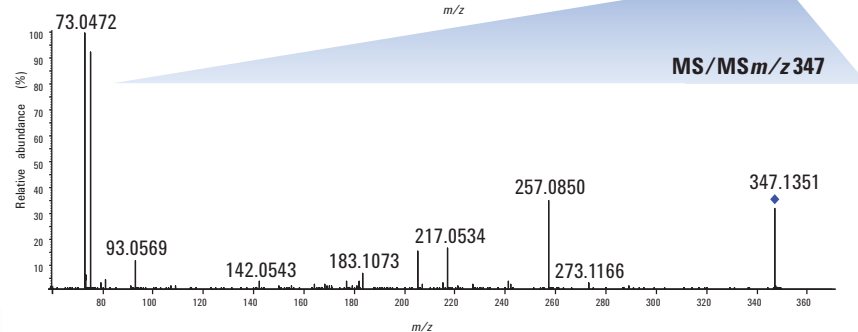
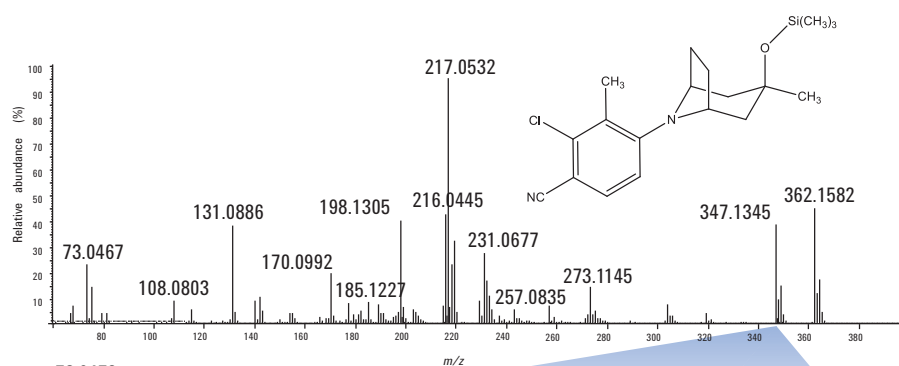

Accurate mass product ion spectra are crucial for elucidating fragmentation pathways in doping studies.

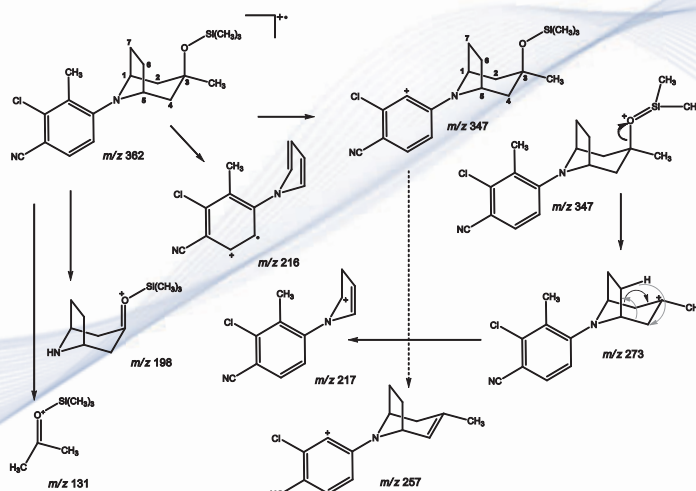

Reference:

Thevis, et al., Rapid Commun. Mass Spectrom. 2013, 27: 1173

VISUALIZE METABOLOMIC CHANGES TO BACTERIA USED IN BIOFUEL PRODUCTION

Concerns about CO₂ emissions – together with the limited availability of fossil fuels – have created an interest in engineering microorganisms to generate sustainable alternatives. Photosynthetic CO₂-fixing microorganisms, such as cyanobacteria, show particular promise for fuel generation because of their ability to utilize greenhouse gas as a carbon source, and light as an energy source.

Metabolomic studies play a key role in evaluating these microorganisms. They allow you to interpret the beneficial effects of specific mutations – and detect potential biochemical pathway bottlenecks that can inhibit development of the biofuel production host.

The Agilent 7200 Series GC/Q-TOF is well suited for analyzing changes in metabolite profiles; from there, you can use accurate mass to confirm metabolite identity.

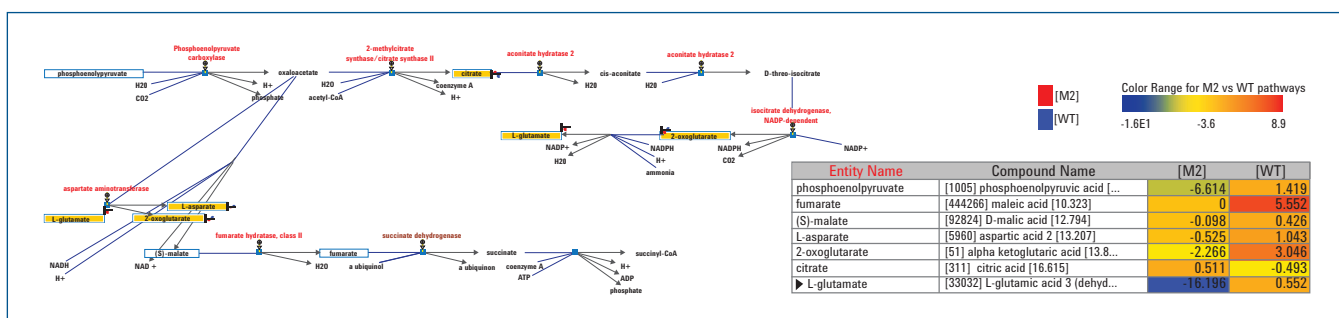

MPP pathway analysis: mapping metabolome differences between biochemical pathways.

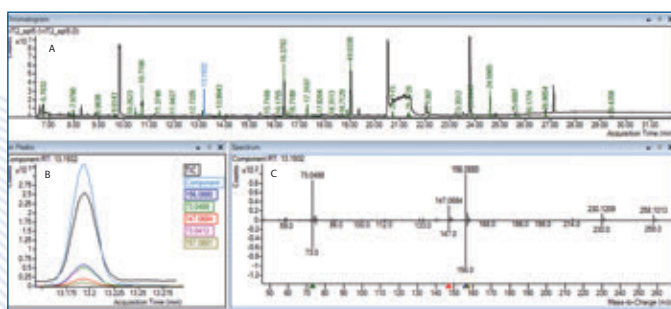

You can use the **Unknowns Analysis tool** for fast, accurate mass deconvolution and library searches.

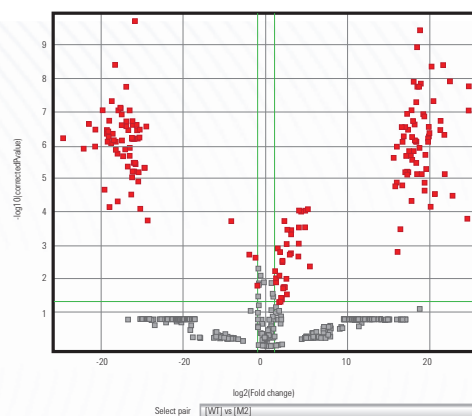

MPP provides powerful statistical analysis and visualization tools for efficiently identifying metabolomic differences.

Reference:

Metabolomics of Carbon-Fixing Mutants of Cyanobacteria by GC/Q-TOF Pub No. 5991-3476EN

To learn more about the capabilities of the Agilent 7200 Series GC/Q-TOF, visit agilent.com/chem/GCMS_QTOF

COUNT ON THE INDUSTRY'S BEST GC/MS SYSTEMS FOR CONSISTENT, ROUTINE ANALYSIS

Agilent's diverse GC/MS portfolio has exactly what you need to boost your lab's performance and productivity, including:

- High-sensitivity detectors for every sample type
- Flexible configurations that can accommodate demanding out-of-lab measurements and cross-industry regulations
- Advanced analysis capabilities
- Optimized throughput and uptime
- Performance turbo, standard turbo, and diffusion pump options
- An inert ion source for trace analyses



Agilent 5977A Series GC/MSD

- Higher sensitivity with new Extractor Ion source and tuning protocols
- Newly integrated hardware and software features simplify workflow
- An affordable GC/MSD option is available with the 5977E GC/MSD
- The transportable 5975T LTM GC/MSD brings lab performance out of the lab



Agilent 7000 Series Triple Quadrupole GC/MS

- Routine femtogram-level sensitivity and superior selectivity
- Up to 500 MRM transitions per second



Agilent 7010 Triple Quadrupole GC/MS

- Ultra efficient electron ionization
- Faster analysis with lower detection limits



Agilent GC/MS Analyzers

- Ready-to-use packaged workflow solutions for over 60 major applications
- Pre-configured and factory tested with application-specific method and standards checkout mixture

The broadest portfolio of samplers

Agilent Q-TOF GC/MS supports all of your sample introduction needs with a wide range of devices for liquids, headspace, gases – and even solids.



Agilent 7693A Series Automatic Liquid Sampler



PAL Autosampler



Agilent 7693 Automatic Liquid Sampler (ALS)



Thermal Separation Probe

A LIFETIME OF PEAK PERFORMANCE FOR YOUR INSTRUMENT – PLUS MAXIMUM PRODUCTIVITY FOR YOUR LAB

As the world's chromatography leader, Agilent is uniquely positioned to bring you innovative sample prep products, GC columns, and Inert Flow Path supplies to help you meet your toughest analytical challenges.

Achieve accurate, reproducible results with fewer repeated samples

Only Agilent offers a complete line of sample prep products to suit your analyses and instrumentation.

- **Agilent Bond Elut polymeric SPE products** provide the cleanest extracts and selectively remove interferences from complex matrices. Choose from over 40 phase functionalities in more than 30 formats – the widest variety on the market today.
- **Industry-leading Agilent QuEChERS kits** are a cost-effective way to make sample preparation faster, easier, and more reliable.



Learn more at agilent.com/chem/sampleprep

Ensure reliable, consistent inertness from injector to detector

The Agilent Inert Flow Path ensures the inertness of every surface that touches your sample, so you can decrease analyte adsorption and achieve the parts-per-billion – or parts-per-trillion – detection levels that today's analyses demand.

- **Agilent J&W Ultra Inert GC columns** are tested with the industry's toughest test probe mixture to ensure consistent column inertness and exceptionally low column bleed.
- **Ultra Inert liners** deliver a robust, reproducible, and reliable inert flow path – with or without glass wool.
- **Split/Splitless inlet option** provides an extra measure of flow path inertness.
- **Ultra Inert gold seals** feature deactivation chemistry applied *on top* of their gold plating for the most inert surface and highest-quality seal.
- **UltiMetal Plus Flexible Metal ferrules** are compatible with Capillary Flow Technology fittings, promoting a leak-free seal that requires less torque.
- **Gas Clean filter systems** deliver the cleanest possible gas, reducing column damage and sensitivity loss.
- **GC detectors** allow the selectivity or sensitivity that your application requires.



Learn more at agilent.com/chem/inert

To learn more about the capabilities of the Agilent 7200 Series GC/Q-TOF, visit agilent.com/chem/GCMS_QTOF



AGILENT 7200 SERIES GC/Q-TOF

RELIABLE STRUCTURAL CONFIRMATION OF TARGETS, NON-TARGETS, AND UNKNOWNNS

The **Agilent 7200 Series GC/Q-TOF** is the world's first Q-TOF designed specifically for GC/MS. It combines proven technologies from the Agilent 7890B GC, 7000B Triple Quadrupole GC/MS, and 6500 Series high-resolution LC/Q-TOF MS. Its advantages include:

- **Highly accurate mass assignments:** A dual-gain amplifier with dual analog-to-digital detection records multiple events over wide mass and dynamic ranges.
- **32 Gbit/s sampling rate:** 4 GHz ADC electronics improve resolution, mass accuracy, and sensitivity for low-abundance samples.
- **24/7 mass accuracy:** Our proprietary INVAR flight tube, sealed in a vacuum-insulated shell, stabilizes mass calibration against thermal change.
- **Fast, high-quality MS/MS spectra:** Ions are accelerated in Agilent's unique hexapole collision cell.
- **Easy routine maintenance:** Change the removable ion source, lens, and filaments without venting the high-vacuum mass analyzer.

For more information

Learn more

agilent.com/chem/GCMS_QTOF

U.S. and Canada

1-800-227-9770

agilent_inquiries@agilent.com

Europe

info_agilent@agilent.com

Asia Pacific

inquiry_lsca@agilent.com

In other countries, please call your local Agilent Representative or Agilent Authorized Distributor – visit agilent.com/chem/contactus

Agilent services let you spend more time on what you do best



Whether you need support for a single instrument or a multi-lab, multi-vendor operation, **Agilent Advantage Service** plans help you solve problems quickly, increase your uptime, and optimize your resources. Our coverage options include:

- On-site preventive maintenance to ensure dependable operation
- Troubleshooting and repair for Agilent and non-Agilent instruments
- Remote diagnostics and monitoring to maximize productivity
- Industry-leading regulatory compliance services and education
- Expert consulting and training



Agilent value promise

We guarantee you at least 10 years of instrument use from your date of purchase, or we will credit you with the residual value of the system toward an upgraded model.

This information is subject to change without notice.

© Agilent Technologies, Inc. 2014
Printed in the USA August 25, 2014
5990-8194EN



Agilent Technologies