

Transportable Benchtop Raman Instruments Agility™ Series (Single/Dual-band)



RUGGED SOLID STATE



HIGH RESOLUTION
HIGH THROUGHPUT



OPTIMIZED COOLING



COST EFFECTIVE



Pervasive Spectroscopy

www.bayspec.com

Transportable Benchtop Raman

Raman spectroscopy is a non-destructive, non-contact analytical technique that requires little or no sample preparation. With falling price barriers and reduction in physical dimensions its application areas are rapidly expanding, from lipid content determination in algae to crystal form identification in zeolites. Some of the most common application areas are highlighted below.



Chemical

- Incoming/outgoing materials inspection and certification
- Online/at-line detector for Process Analytical Technology (PAT)
- Polymers: correlation of physical/chemical properties (molecular weight, viscosity, glass transition temperature, etc.) with Raman spectra
- Petroleum product identification and analysis
- Identification of resins, petrochemicals, and commodity chemicals



Biological

- In situ, non-contact measurement of tissue samples, non-destructive, no labeling needed
- Intracellular chemical mapping
- Lipid content quantization in algae for biofuels
- Bacteria detection
- SERS for low level biological threat detection



Homeland Security & Defense

- IED/HME explosives detection
- Unknown substance ID
- Forensics analysis
- Border patrol/TSA screening



Pharmaceutical

- Drug polymorphs/solvates identification and classification
- Identification of drug crystals
- Content analysis of tablets, gel caps, and liquids
- QA/QC of API, additives, and excipients
- Fast analytical tool for high throughput screening



Forensics

- Non-destructive and safe drug and narcotic identification/preservation of evidence
- Identification of explosives
- Trace forensic analysis of fibers, hair, pigments, ink, fabrics, etc.
- Toxic solvents identification



Food Safety & Agriculture

- Port of entry inspections
- Pesticides & herbicides
- Field audits
- Bacterial contamination



Geological

- Non-destructive identification of geological materials
- Authentication and anti-counterfeiting of gemstones
- Origin identification of minerals and gemstones
- Evaluation of mining prospects and alteration mineralogy



Semiconductor/Thin films

- Wafer defect inspection
- Thin film coatings
- In-line process
- QA/QC

Selection of Gratings and Wavelength Range

The core of the Agility's optical design features a transmissive Volume Phase Grating (VPG™) spectrograph. As BaySpec manufactures the gratings in-house, we can customize the spectral range for the spectral range of interest so to maximize resolution and reliable performance. Measurements are performed over the full spectral range at a high resolution in a single acquisition as seen in the spectrum below.

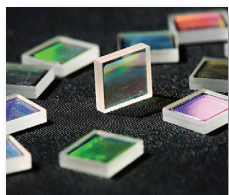

Customers can choose cut-off ranges in the 1st, 2nd, 3rd overtone fingerprint region 200-1850 cm⁻¹ or select extended versions out to 100-3200 cm⁻¹ to capture the important information in the combination bands.

Dispersive Spectrometer Schematic

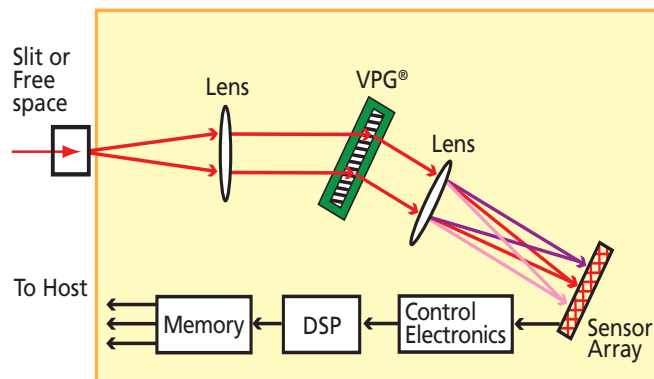

Schematic diagram of the core spectrometer engine based on a high-throughput transmission holographic Volume Phase Grating (VPG®)

Selection of Excitation Wavelength, New 1064 nm Option

Often the question is asked when configuring a Raman instrument “which excitation wavelength is best?” BaySpec offers many options for excitation wavelengths, and multiple laser wavelengths may be employed so technologists can have the flexibility to address different sample materials.

For many samples, especially those of an organic or biological nature, fluorescence is a particular concern. Exciting these samples with a laser in the green (532 nm) may promote this fluorescence, and may swamp any underlying Raman spectrum to such an extent that it is no longer detectable.

In this instance, the use of a laser in the red (633 nm) or NIR (785 nm) may provide a solution. With the lower photon energy, a red or NIR laser may not promote the electronic transition (and hence the fluorescence) so the Raman scatter may be far easier to detect.

BaySpec also offers a unique 1064 nm wavelength option for difficult to measure samples. Longer 1064 nm excitation is the preferred wavelength for most petrochemical samples, street drugs, explosives and other mixture samples exhibiting strong fluorescence.

Conversely, as one increases the wavelength from green to red to NIR the scattering efficiency will decrease, so longer integration times or higher power lasers may be required.

Thus, it is often most practical to have a number of laser wavelengths available to match the various sample properties one may encounter, be it resonance enhancements, penetration depth, or fluorescence. This is the rationale behind BaySpec's unique Agility™ Dual Band systems, allowing unrivaled performance and suitability for a wide array of sample types.

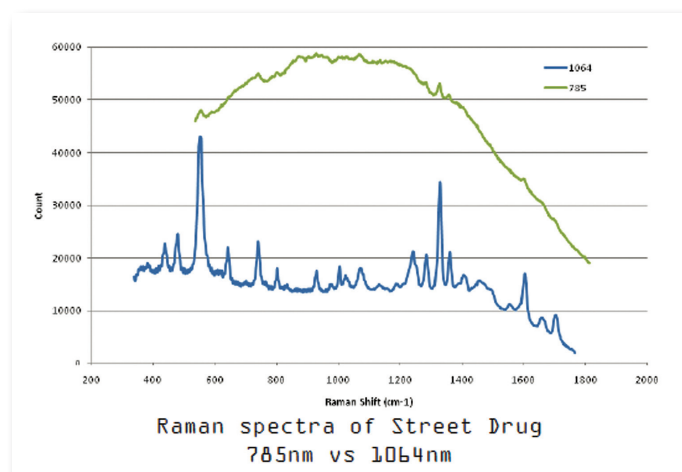

785 and 1064 nm laser excitation of a fluorescent sample.



Specifications

Model	Agility™		
OPTICAL			
Excitation Wavelength	532 nm	785 nm	1064 nm
Wavelength Range	200 to 3500 cm ⁻¹	100 to 2300 cm ⁻¹	100 to 2300 cm ⁻¹
Resolution (FWHM)	9 to 12 cm ⁻¹	6 to 9 cm ⁻¹	12 to 17 cm ⁻¹
Wavelength Calibration	Automatic via software	Automatic via software	Automatic via software
Spectrograph	f/2; Transmissive VPG®	f/2; Transmissive VPG®	f/2; Transmissive VPG®
Integration Time	5 ms to 600 s	5 ms to 600 s	1 ms to 20 s
Detector Array	2048 px CCD	2048 px CCD	256 px InGaAs
Cooling	2 stage TE	2 stage TE	2 stage TE
Cooling Time	<1 min	<1 min	<1 min
Laser Power	50 mW	0~450 mW adjustable	0~450 mW adjustable
ELECTRICAL			
A/D Converter	16 Bit	16 Bit	16 Bit
Power Consumption	<25 W	<25 W	<25 W
Power Source	AC 100-240 V; DC 11-24 V (optional)	AC 100-240 V; DC 11-24 V (optional)	AC 100-240 V; DC 11-24 V (optional)
Battery (optional)	Lithium ion	Lithium ion	Lithium ion
Battery Life	~4 hr	~4 hr	~4 hr
Charge Time (full capacity)	~6 hr	~6 hr	~6 hr
PHYSICAL			
Dimensions: mm; in	305(d) x 380(w) x 168(h); 12 x 15 x 6.6	305(d) x 380(w) x 168(h); 12 x 15 x 6.6	305(d) x 380(w) x 168(h); 12 x 15 x 6.6
Weight	14 lb	14 lb	14 lb
Operating Ranges	0 to 45°C; 0 to 95% RH	0 to 45°C; 0 to 95% RH	0 to 45°C; 0 to 95% RH
SAMPLING OPTIONS			
Fiber Probe	Coaxial, AR coated, filtered	Coaxial, AR coated, filtered	Coaxial, AR coated, filtered
Liquid Sample Holder	Holds vials, tubes, cuvettes	Holds vials, tubes, cuvettes	Holds vials, tubes, cuvettes
Pill Holder	Solid or liquid capsules	Solid or liquid capsules	Solid or liquid capsules
Solid Sample Holder	Upright or inverted options	Upright or inverted options	Upright or inverted options
COMPUTER			
Operating System	Windows-based (32 or 64 Bit)	Windows-based (32 or 64 Bit)	Windows-based (32 or 64 Bit)
System Control	Onboard touchscreen or external PC	Onboard touchscreen or external PC	Onboard touchscreen or external PC
Data Ports	USB 2.0	USB 2.0	USB 2.0
Security	Tiered password structure (3 levels), event logging and reporting	Tiered password structure (3 levels), event logging and reporting	Tiered password structure (3 levels), event logging and reporting
Internal Storage	16 GB	16 GB	16 GB
Wireless Connectivity	WiFi (optional)	WiFi (optional)	WiFi (optional)
Spectral Libraries	BaySpec Factory Library, user-defined, 3rd party options	BaySpec Factory Library, user-defined, 3rd party options	BaySpec Factory Library, user-defined, 3rd party options

*Need a custom wavelength range? Contact our applications staff to help configure your optimized solution. +1 (408) 512-5928 or info@bayspec.com





Specifications

Model	Agility™ Dual Band	
OPTICAL		
Excitation Wavelength	532 and 1064 nm	785 and 1064 nm
Wavelength Range	200 to 3500 cm ⁻¹ (532nm); 100 to 2300 cm ⁻¹ (1064nm)	100 to 2300 cm ⁻¹
Resolution (FWHM)	9 to 12 cm ⁻¹ (532nm); 12 to 17 cm ⁻¹ (1064nm)	6 to 9 cm ⁻¹ (532nm); 12 to 17 cm ⁻¹ (1064nm)
Wavelength Calibration	Automatic via software	Automatic via software
Spectrograph	f/2; Transmissive VPG®	f/2; Transmissive VPG®
Integration Time	5 ms to 600 s (532nm); 1ms to 20 s (1064nm)	5 ms to 600 s (785nm); 1ms to 20 s (1064nm)
Detector Array	2048 px CCD; 256 px InGaAs	2048 px CCD; 256 px InGaAs
Cooling	2 stage TE	2 stage TE
Cooling Time	<1 min	<1 min
Laser Power	50 mW (532nm); 0~450 mW adjustable (1064nm)	0~450 mW adjustable
ELECTRICAL		
A/D Converter	16 Bit	16 Bit
Power Consumption	<30 W	<30 W
Power Source	AC 100-240 V; DC 11-24 V (optional)	AC 100-240 V; DC 11-24 V (optional)
Battery (optional)	Lithium ion	Lithium ion
Battery Life	~3 hr	~3 hr
Charge Time (full capacity)	~6 hr	~6 hr
PHYSICAL		
Dimensions: mm; in	305(d) x 380(w) x 168(h); 12 x 15 x 6.6	305(d) x 380(w) x 168(h); 12 x 15 x 6.6
Weight	16 lb	16 lb
Operating Ranges	0 to 45°C; 0 to 95% RH	0 to 45°C; 0 to 95% RH
SAMPLING OPTIONS		
Fiber Probe	Coaxial, AR coated, filtered	Coaxial, AR coated, filtered
Liquid Sample Holder	Holds vials, tubes, cuvettes	Holds vials, tubes, cuvettes
Pill Holder	Solid or liquid capsules	Solid or liquid capsules
Solid Sample Holder	Upright or inverted options	Upright or inverted options
COMPUTER		
Operating System	Windows-based (32 or 64 Bit)	Windows-based (32 or 64 Bit)
System Control	Onboard touchscreen or external PC	Onboard touchscreen or external PC
Data Ports	USB 2.0	USB 2.0
Security	Tiered password structure (3 levels), event logging and reporting	Tiered password structure (3 levels), event logging and reporting
Internal Storage	16 GB	16 GB
Wireless Connectivity	WiFi (optional)	WiFi (optional)
Spectral Libraries	BaySpec Factory Library, user-defined, 3rd party options	BaySpec Factory Library, user-defined, 3rd party options

*Need a custom wavelength range? Contact our applications staff to help configure your optimized solution. +1 (408) 512-5928 or info@bayspec.com

Agility™ Quick-Change Sample Options

The BaySpec Agility™ series offers users the most versatile sampling options available, with a number of inserts that can be rapidly exchanged within the base system. These inserts maintain the precise optical alignment necessary to ensure high-quality spectral acquisition, and accommodate a number of sample types. These options include a vial holder (2 and 4 ml disposable glass vials, cuvettes, tubes) for liquids and powders, a fiber adapter for attachment of a remote fiber probe, a solid sample insert with upright or inverted configuration, and a pill holder for liquid and solid capsules.



Liquid-vial insert



Solid sample insert



Pill holder



Fiber probe adapter

Agile 20/20 software

Agile 20/20 is a Windows®-based graphical user interface (GUI) application program for interfacing with BaySpec's Agility™ Raman devices. It can perform the following tasks: acquire and analyze spectra, calibrate wavelength, verify and identify substances, and manage user-built or third-party spectral libraries. Agile 20/20 is provided on the embedded touchscreen computer interface of every Agility™, and disks are included for installation onto an external computer.

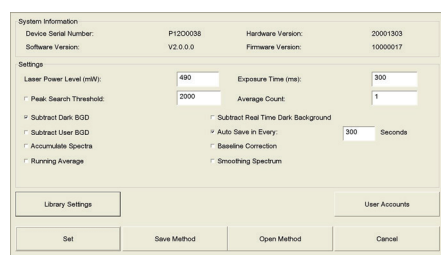
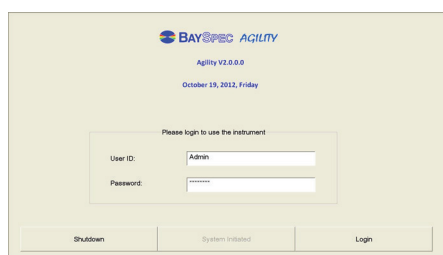

Security Features:

Agile 20/20 supports the US FDA 21 CFR Part 11 for security levels, electronic signatures, and records for audit trail of data. Users can save, view and print analysis reports. Password levels also control access to advanced or simple user interface.

Simple Measurement Control:

For novice or restricted-access users, a simple interface is presented for substance identification and verification. All measurement settings are automated to aid the non-spectroscopist.

Advanced Measurement Control:

Experienced users are able to control all aspects of the spectral measurement, including laser power adjustment, integration time, background subtraction, processing procedures, and library search settings.

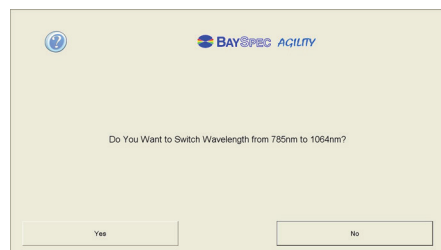
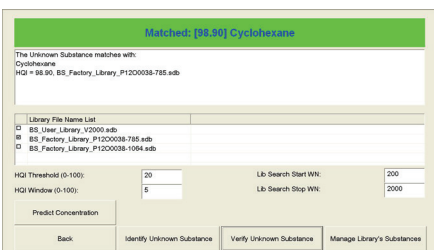
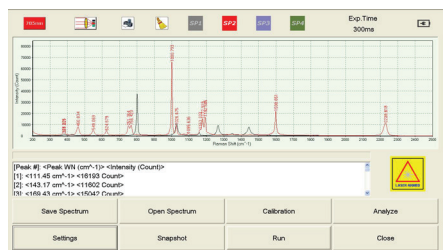

Intuitive Graphical User Interface (GUI):

Important setup parameters, spectrum display, and real-time status indicators are all on a single, easy-to-see screen, especially designed for touchscreen operations.

Substance Identification Functions:

Whether the library is user built or imported from third parties, Agile 20/20 can identify unknown substances instantaneously and quantitatively report the match quality. It can even be trained to recognize mixtures.

Automated System Configuration:

Switch from internal measurement to probe measurement with just the push of a button. Or change excitation wavelength in your dual-band system. Even wavelength calibration is automated on the Agility™.

Raman Solutions

With its available excitation wavelengths, versatile sampling options, transportable size, and high spectral performance, the Agility™ is an ideal analytical tool for your toughest applications. The available 1064 nm option in single or dual-band configuration extends its capability well beyond any previous instruments its size.



Pharmaceuticals

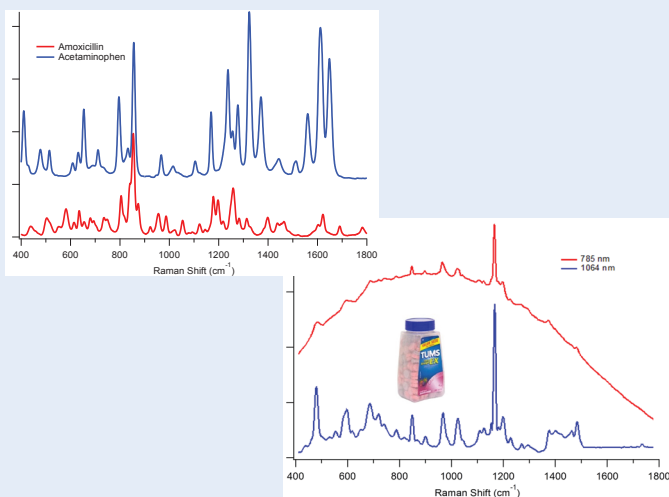

Agility™ simplifies Raman characterizations of pharmaceuticals with accuracy and speed, regardless of the samples' forms (pills, creams, liquids, or capsules).

Explosives

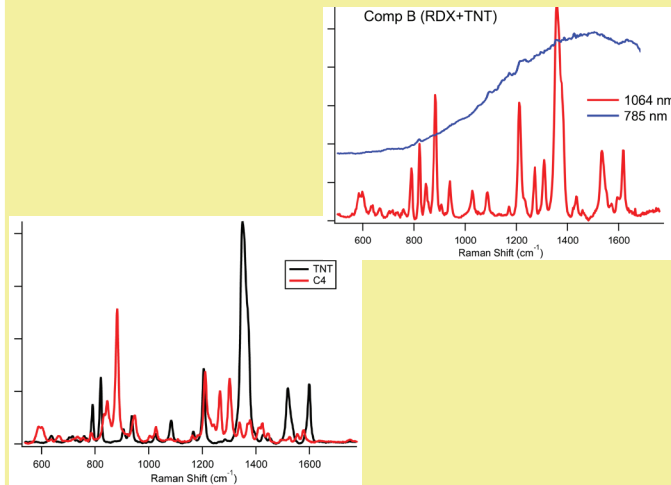

With fiber probe connectivity, dual-band options and customizable spectral libraries, the transportable and ruggedized Agility™ detects and characterizes explosives directly in the field.

Fuels

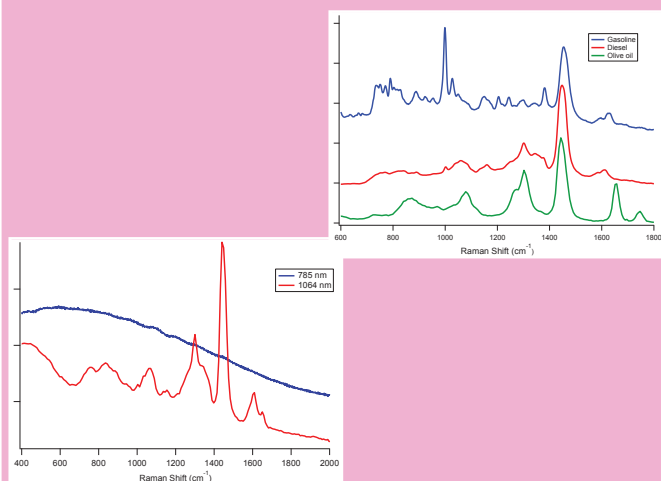

Petroleum and its derivatives, such as lubricants, fuels (including biofuels) and many other chemicals have not been "Raman-compatible" in the past, due to their high fluorescence. With superior fluorescence avoidance in the 1064 nm Agility™, quantitative characterization of these samples is now an easy task.

Counterfeits

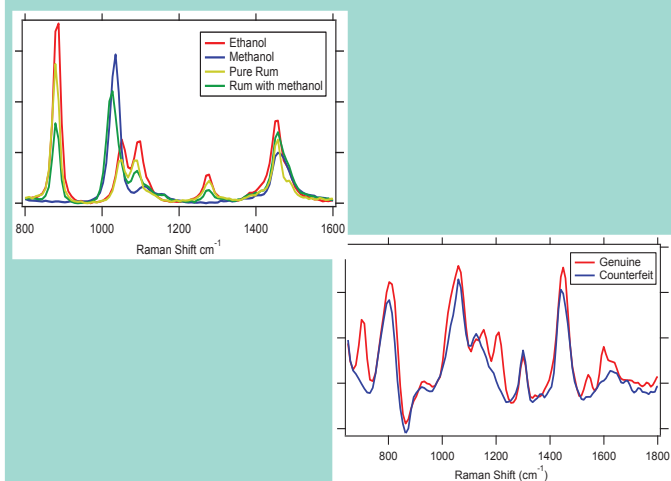

No matter how identical a counterfeit's physical characteristics matches the genuine product, the chemical differences become obvious through the Agility™ Raman spectrum.

Founded in 1999 with support from some of the leading corporations and venture capital firms in Silicon Valley, BaySpec is a vertically integrated spectral sensing company. The company designs, manufactures and markets advanced spectral instruments, from UV-VIS spectrometers to portable and benchtop, microscope Raman, NIR and Raman analyzers, for the biomedical, pharmaceuticals, chemical, food, semiconductor, homeland security, and the optical telecommunications industries.

Engineering and Product Development

- Shortest product development cycle in the industry
- Extensive intellectual property covering key aspects of our products
- In-house capabilities encompassing all the important and critical components, from lasers to gratings and state-of-the-art detectors

Production

- 48,000 square foot production facility, including 9,000 square foot Class 10,000 clean room
- History of producing and delivering more than 35,000 spectral engines of all types
- 100% made in the USA

Quality Control

Dedicated team and established procedures to ensure consistent and reliable product delivery



Safety and Environment

At BaySpec the safety of our employees and customers is our utmost concern. Rigorous training programs are implemented for laser, electrical, and hazardous materials safety. All products we release are extensively reviewed for any potential safety hazard. Every precaution is exercised, whether via hardware design or software control, to prevent safety issues from occurring. BaySpec is committed to green manufacturing techniques and processes. We strive to minimize or eliminate the use of hazardous materials in every manufacturing step, thus benefitting the health and well being of our employees and the environment. Our spectral sensing products are compact, energy efficient, and do not generate hazardous waste during normal usage.



Pervasive Spectroscopy

Contact info:

BaySpec, Inc.
1101 McKay Drive
San Jose, CA 95131
USA

Tel: +1 (408) 512-5928
Fax: +1 (408) 512-5929
Web: www.bayspec.com
email: sales@bayspec.com

All BaySpec products are made in the USA