



The Most Accurate Atomic Force Microscope

Park NX-PTR

Fully Automated AFM for
Accurate Inline Metrology of Hard Disk Head Sliders





Park NX-PTR

The only automated AFM for inline PTR measurement

Inline Automation, for Fast, Accurate, and Repeatable PTR Measurements

The hard disk drive slider manufacturing industry demands a tool that provides fast, streamlined Pole Tip Recession Measurements while still maintaining the highest standard of accuracy available. It demands a tool like the Park NX-PTR. The NX-PTR offers extremely accurate PTR measurements to process engineers with inline automation that increases throughput. This makes it the perfect solution for HDD slider manufacturers looking to maximize their quality and production yield.

High Throughput, with No Need for Multiple Reference Scans

Most AFMs require multiple scans to get accurate PTR measurements - First macroscale reference scans then high-resolution scans of smaller areas of interest. This multi-scan process takes time and limits throughput. Our crosstalk eliminated scan system allows for truly flat scans, effectively eliminating the multi-scan process. In addition, True Non-Contact™ Mode preserves tip sharpness for prolonged high resolution imaging and much longer tip life. This lets the Park NX-PTR generate accurate images of highly detailed regions of interest within larger macrostructures, without any need of reference scan to correct various scanner artifacts.

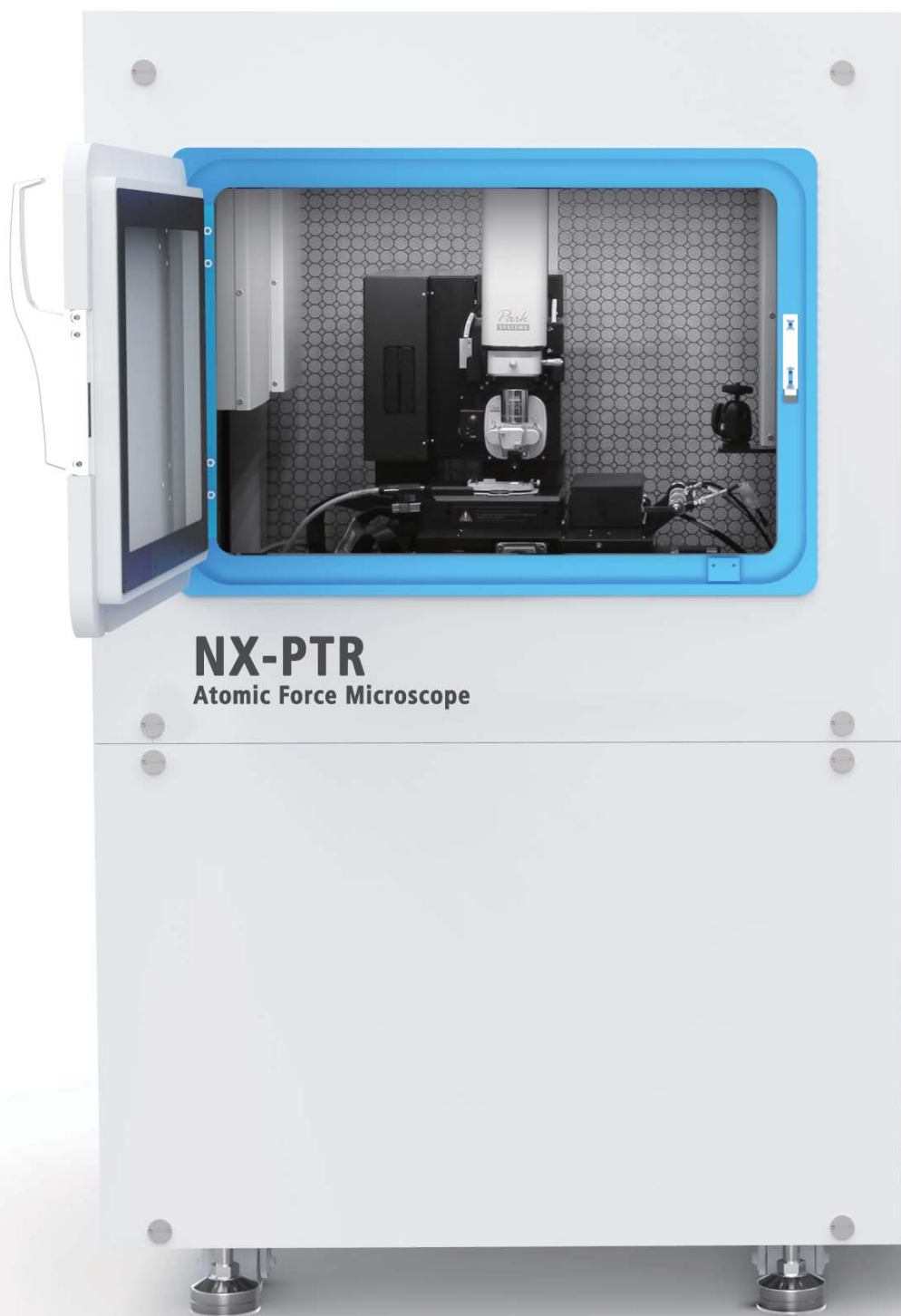

NX-PTR
Atomic Force Microscope



Park NX-PTR

Powerful features for high throughput inline PTR measurements

Be more productive with Fully Automated AFM for Inline Hard Disk Slider Metrology

- Automated PTR imaging in non-contact mode
- Automated analysis of PTR images for carrier, rowbar, or individual slider
- Automatic tip exchange (optional)
- Industry's lowest system noise of less than 0.5 Å rms

Accurate and Repeatable Measurements for Improved Production Yield

- Accurate imaging of HDD sliders without any need of larger sized reference scans
- Accurate height and angle measurements for industry leading PTR gauge repeatability
- Flat and orthogonal XY scan removes artifacts from background curvature
- Superior tool-to-tool matching

Accurate Height Measurements with Low Noise Z Detector

- True Sample Topography™ without edge overshoot or piezo creep error
- Accurate surface height recording, even during high-speed scanning
- Industry leading forward and backward scan gap of less than 0.15%

Best Tip Life and Scan Resolution by True Non-Contact™ Mode

- 10 times or longer tip life during PTR measurements than any other AFMs
- Minimal tip wear from prolonged high-quality scans
- Minimized sample damage or modification

Park NX-PTR

Productivity meets Accuracy

Automated Inline Measurements of Hard Disk Sliders

The key to improving the production yield of hard disk sliders with shrinking dimensions and increasing complexity is accuracy at the nanoscale. Park NX-PTR provides accurate, automatic measurements for hard disk sliders.

Automatic PTR Measurement and Analysis

Pole Tip Recession measurements are fully automated with the NX-PTR system, giving you higher throughput capability, both at the carrier, rowbar, and slider level.

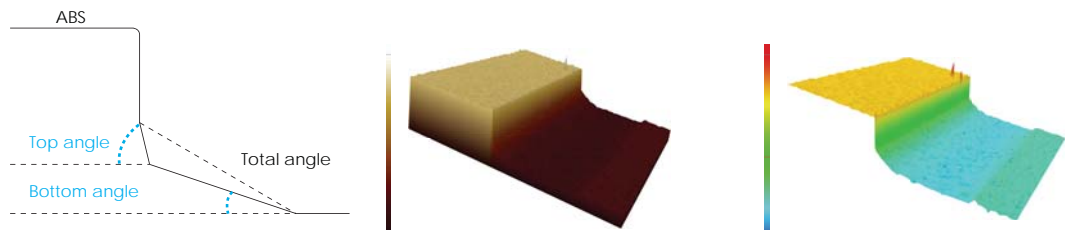
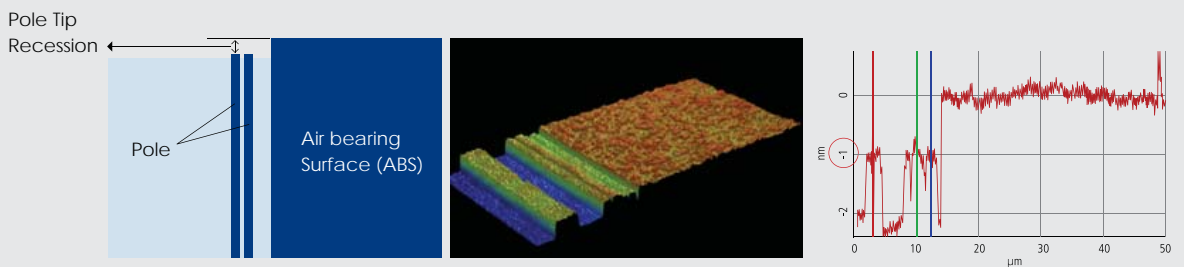

Automatic Wall Angle Measurement & Analysis

Automatically get measurement and analysis of the various wall angle applications.

Automatic Defect Measurement and Analysis

Measurement and analysis of various defects such as edge spikes are fully automated.

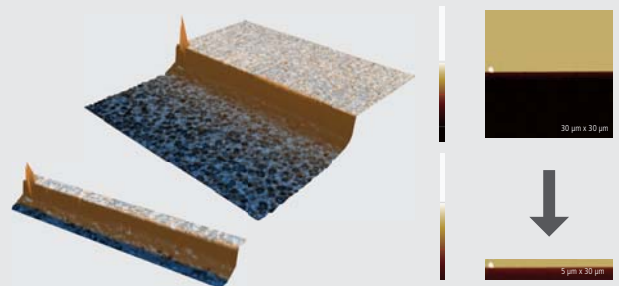

Automatic Tip Exchange

Park's automatic tip exchange system lets you seamlessly continue automated measurement routines. It automatically calibrates cantilever location and optimizes measurement settings based on measurements of a reference pattern. Our novel magnetic approach to the tip exchange has a 99% success rate, so you can do better work with less oversight.



Automatic Laser Beam Alignment

Park's automatic laser beam alignment lets the user seamlessly continue automated measurement routines without user input. With our advanced pre-aligned cantilever holder, the laser beam is focused on the cantilever upon automatic tip exchange. The laser spot is then optimized along the X- and Y-axis by motorized positioning knobs.



Laser beam is always focused on the cantilever upon its placement



Park NX-PTR

Powerful and yet reliable AFM

Industry's Lowest Noise Floor

To detect the smallest sample features, and image the flattest surfaces, Park has engineered to achieve the industry's lowest noise floor specification of $< 0.5 \text{ \AA}$. The noise floor data is determined using a "zero scan." The system noise is measured with the cantilever in contact on the sample surface at a single point under the following conditions:

- 0 nm x 0 nm scan, staying at one point.
- 0.5 gain in contact mode
- 256 x 256 pixels

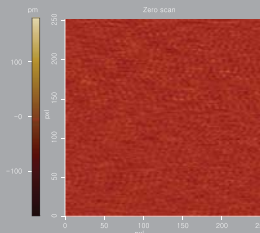

Typically 0.3 \AA rms or lower

Statistics

Region	Mid(pm)	Mean(pm)	Rpv(pm)	Rq(pm)	Ra(pm)
Red	0.000	-0.011	359.496	30.025	19.177

Gauge Repeatability and Reproducibility

Due to the ever-decreasing size of components, manufacturers now require the highest level of quality control. Park AFM can provide 1 gauge sigma of less than 1 angstrom.

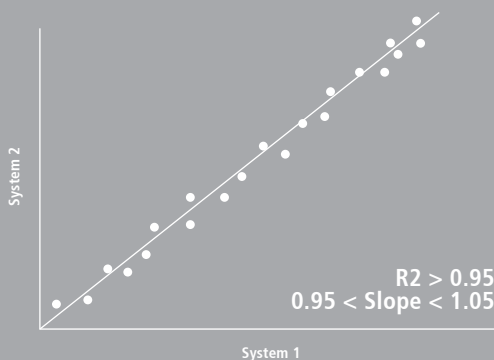
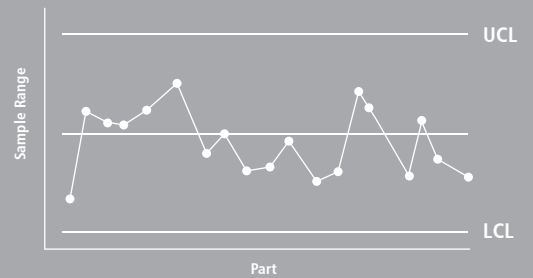

Tool-to-tool Correlation

Thanks to Park's revolutionary AFM platform that was designed for industrial metrology, Park NX-PTR will correlate with any existing Park AFMs that have been previously used for manufacturing, inspection, analysis, or research.

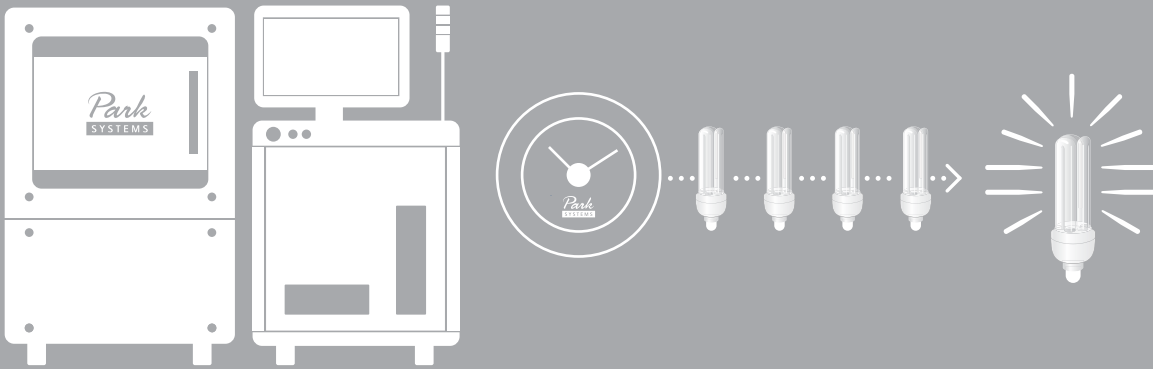

System Uptime

Our engineers and scientists have adopted the most rigorous industry standard product development to ensure the highest level of system reliability. Park NX-PTR can be incorporated seamlessly either as an inline or as an offline inspection tool, with minimal maintenance requirements.



Service and Maintenance

Park is committed to the highest level of service and support. We put every effort to understand our customers' needs. We place the highest priority in meeting promised delivery dates, guaranteed quality, and thorough after-sales service.

Industry Leading Low Noise Z Detector

Our AFMs are equipped with the most effective low noise Z detectors in the field, with a noise of 0.2 Å over large bandwidth. This produces highly accurate sample topography, no edge overshoot and no need for calibration. Just one of the many ways Park NX-PTR saves you time and gives you better data.

Accurate Sample Topography Measured by Low Noise Z Detector

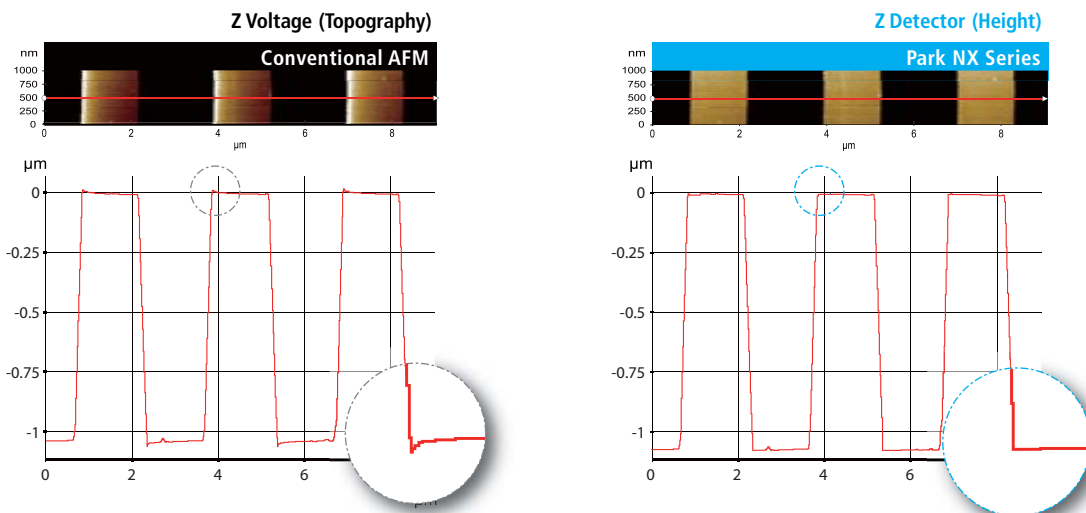

Sample: 1.2 μm Nominal Step Height (9 μm x 1 μm, 2048 pixels x 128 lines)

Piezoelectric creep effect

No creep effect

No artifact by AFM scanner in low noise closed-loop topography



- Uses low noise Z detector signal for topography
- Has low Z detector noise of 0.02 nm over large bandwidth
- Has no edge overshoot at the leading and trailing edges
- Needs calibration done only once at the factory

True Non-Contact™ Mode Preserves Sharp Tip

AFM tips are so brittle that touching a sample will instantly reduce the resolution and quality of the image they produce. For soft and delicate samples, the tip will also damage the sample and result in inaccurate sample height measurements, something that can cost you valuable time and money.

True Non-Contact™ mode, a scan mode unique to Park AFMs, consistently produces high resolution and accurate data while maintaining the integrity of the sample.

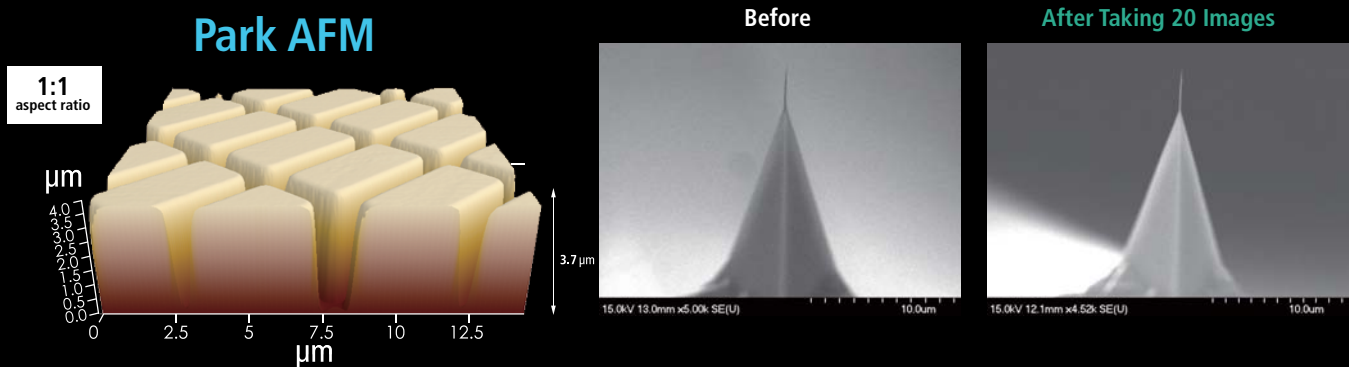

Accurate Feedback by Faster Z-servo enables True Non-Contact AFM

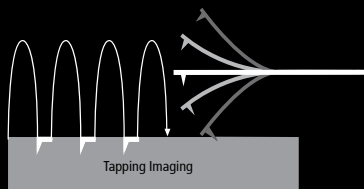

Tapping Imaging

- Quick tip wear = Blurred low-resolution scan
- Destructive tip-sample interaction = Sample damage and modification
- Highly parameter-dependent



True Non-Contact™ Mode

- Less tip wear = Prolonged high-resolution scan
- Non-destructive tip-sample interaction = Minimized sample modification
- Immunity from parameter dependent results

Park NX-PTR

The most innovative AFM technology in one powerful package

Low Noise XYZ Position Sensors for more accurate scans

The NX-PTR provides you with unprecedented accuracy in topography height measurement by utilizing its ultra-low noise Z detector instead of the commonly used Z voltage signal that is non-linear in nature. Industry leading low noise Z detector replace the applied Z voltage as the topography signal and make the forward and backward scan gap a negligible 0.15% of the scan range.

Minimal Thermal Drift and Hysteresis reduces tip drift

The body of the NX-PTR is designed to be extremely mechanically and thermally stable, minimizing thermal drift and giving you more precise measurements. A typical thermal drift rate is less than 100 nm/°C for the lateral direction and 200 nm/°C for the vertical direction.

Automatic Measurement Control so you can get accurate scans with less work

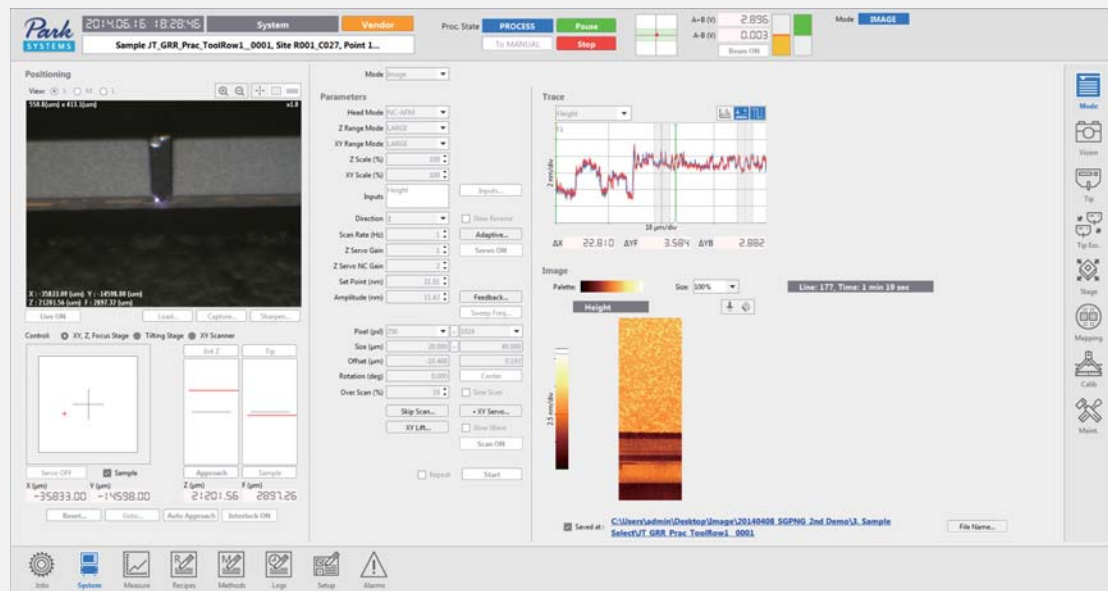

The NX-PTR is equipped with automated software that makes operation nearly effortless. Just select the desired measurement program to get precise multi-site analysis with optimized setting for cantilever tuning, scan rate, gain, and set point parameters.

Park's user-friendly software interface gives you the flexibility to create customized operation routines so you can access the full power of the NX-PTR and get the measurements you need.

Creating new routines is easy. It takes about 10 minutes to create a new routine from scratch, or less than 5 minutes to modify an existing one.

Park NX-PTR's automated system features:

- Auto, semi-auto, and manual mode so you have complete control
- Editable measurement method for each automated routine
- Live monitoring of the measurement process
- Automatic analysis of acquired measurement data

Options

Customize your AFM to make it more efficient and more effective

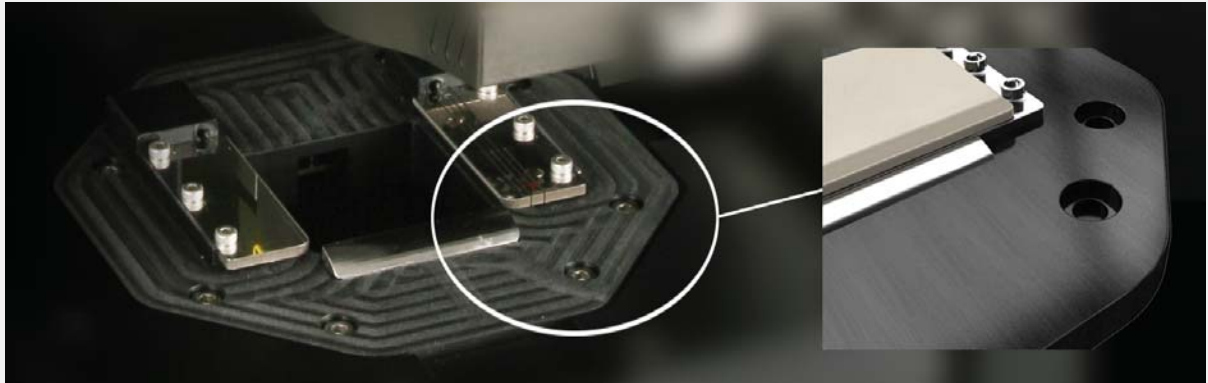

Customized Sample Fixture

Park Systems can prepare customized sample fixtures to support customers' specific samples, row bars or individual sliders. The customized sample fixture can provide a better connection between the measuring sample and the NX-PTR for increased accuracy.



Customized HGA Fixture

HGA fixtures can be custom built to firmly fit a specific HGA design provided by the customer, offering a more stable fixture. The non-damaging fixture allows users to easily load and unload the entire HGA, without causing any damage to the HGA. HGA then can be dismounted, and further tested. Up to 5 HGA samples of the same type can be mounted at the same time.

Ionization System for a more stable scanning environment

Our advanced ionization system quickly and effectively removes electrostatic charges in your sample's environment. Since the system always generates and maintains the ideal balance of positive and negative ions, it can create an extremely stable charge environment with little contamination of the surrounding area, and minimal risk of accidental electrostatic charge during sample handling.

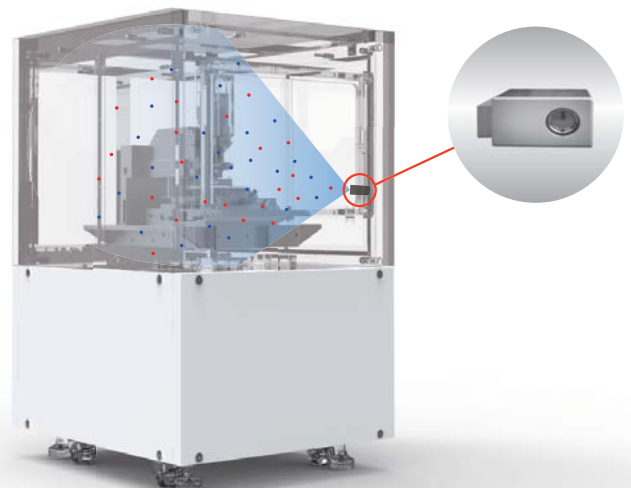

Park NX-PTR

Specification

System Specification	Motorized XY stage	Motorized Z stage	
	travels up to 200 mm × 200 mm, 2 μm repeatability	25 mm Z travel distance 0.1 μm resolution, <1 μm repeatability	
Scanner Performances	XY Scanner Range	XY Scanner Resolution	
	100 μm × 100 μm	0.095 nm (20 bit position control)	
AFM and XY Stage Control Electronics	ADC	DAC	
	18 channels 4 high-speed ADC channels (64 MSPS) 24-bit ADCs for X,Y and Z scanner position sensor	12 channels 2 high-speed DAC channels (64 MSPS) 20-bit DACs for X,Y and Z scanner positioning	
Vibration, Acoustic Noise	Floor Vibration		
	<0.5 μm/s (10 Hz to 200 Hz w/ Active Vibration Isolation System)		
Facility Requirements	Room Temperature (Stand By)	Room Temperature (Operating)	Humidity
	10 °C ~ 40 °C	18 °C ~ 24 °C	30% to 60% (not condensing)
Dimensions in mm & Weight in kg	Acoustic Enclosure	Control Cabinet	
	880 (w) × 980 (d) × 1460 (h) 620 kg approx. (incl. basic NX-PTR System)	600 (w) × 900 (d) × 1330 (h) 170 kg approx. (incl. controllers)	

Motorized Focus Stage	Tilting stage	Sample Thickness Allowance	Z run-out	COGNEX Pattern Recognition
15 mm Z travel distance for on-axis optics	tilt angle: $\pm 1.8^\circ$	up to 20 mm	<2 nm over 80 μm	pattern align resolution of 1/4 pixel
Z Scanner Range	Z Scanner Resolution	Z Scanner Noise Floor		
15 μm	0.01 nm	<0.05 nm (w/ Active Vibration Isolation System)		

Acoustic Noise

>20 dB attenuation w/ Acoustic Enclosure

Floor Vibration Level	Acoustic Noise	Pneumatics	Power Supply Rating	Total Power Consumption	Ground Resistance
VC-E (3 $\mu\text{m}/\text{sec}$)	Below 65 dB	Vacuum: -60 kPa	100/120 V/ 208~240 V, single phase, 15 A (max)	2 KW (typical)	Below 100 ohms

System Floor Space	Ceiling Height	Operator Working Space
1720 (w) \times 920 (d)	2000 or more	2400 (w) \times 2450 (d), minimum

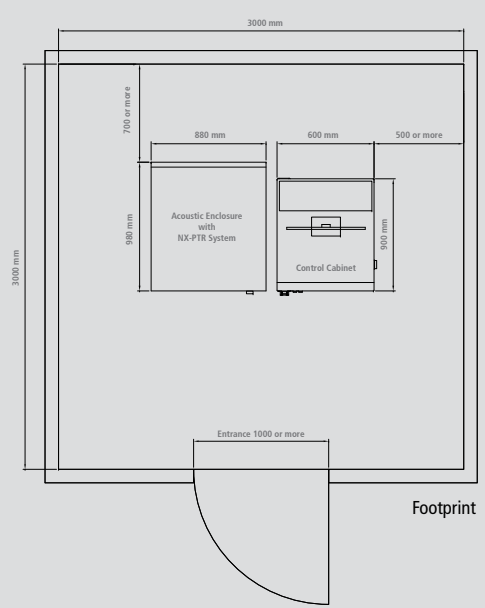
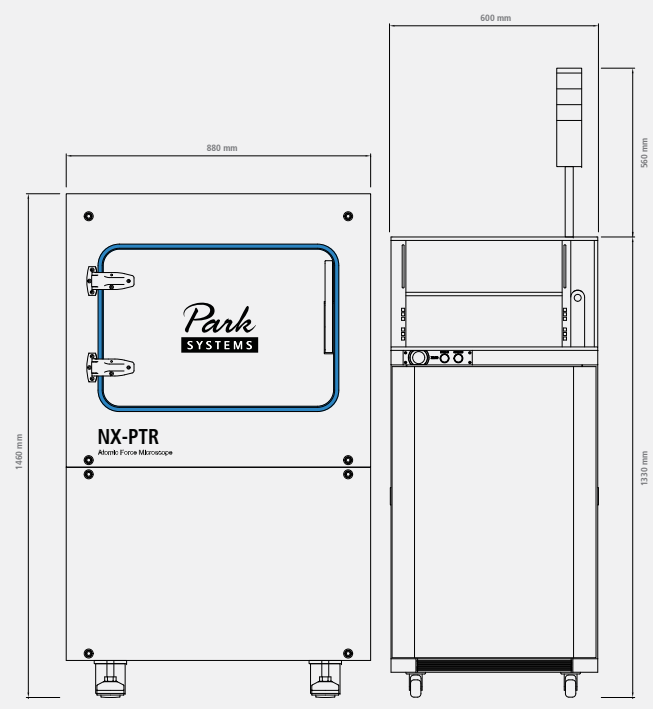

Park Systems

Dedicated to producing the most accurate and easiest to use AFMs

The global headquarters is located at
Korean Advanced Nanotechnology Center (KANC) in Suwon, Korea.



More than a quarter century ago, the foundations for Park Systems were laid at Stanford University where Dr. Sang-il Park, the founder of Park Systems worked as an integral part of the group that first developed AFM technology. After perfecting the technology, he then went on to create the first commercial AFM and later Park Systems was born.

Park Systems strives everyday to live up to the innovative spirit of its beginnings. Throughout our long history, we have honored our commitment to providing the most accurate and yet very easy to use AFMs, with revolutionary features like True Non-Contact™ mode, and many automated software tools. We are not simply content to rest on our past success. All of our products are designed with same care and creativity that went into our first, allowing you to focus on getting results without worrying about the integrity of your tools.



www.parkAFM.com

HEADQUARTERS

GLOBAL HEADQUARTERS: +82-31-546-6800
AMERICAS HEADQUARTERS: +1-408-986-1110
JAPAN HEADQUARTERS: +81-3-3219-1001
SE ASIA HEADQUARTERS: +65-6634-7470

OCEANIA

Australia and New Zealand: +61-2-9319-0122

ASIA

China: +86-10-6401-0651
India: +91-40-655-88-501
Indonesia: +62-21-5698-2988
Malaysia: +603-8065-3889
Philippines: +632-239-5414
Saudi Arabia: +966-2-640-5846
Taiwan: +886-2-8227-3456
Thailand: +662-668-2436
UAE: +971-4-339-2603
Vietnam: +844-3556-7371

EUROPE

France: +33-1-6953-8023
Germany: +49-6103-30098-0
Italy: +39-02-9009-3082
Israel: +972-3-923-9666
Switzerland: +41-22-788-9186
Romania: +40-21-313-5655
Russia: +7 (495) 22-11-208
Spain and Portugal: +34-902-244-343
Turkey: +90-312-236-42-0708
UK and Ireland: +44(0)1372-378-822
Benelux, Scandinavia, and Baltics: +31-184-64-0000

AMERICAS

USA: +1-408-986-1110
Canada: +1-888-641-0209
Brazil: +55-11-4178-7070
Colombia: +57-347-0060
Ecuador: +593-2-284-5287

