

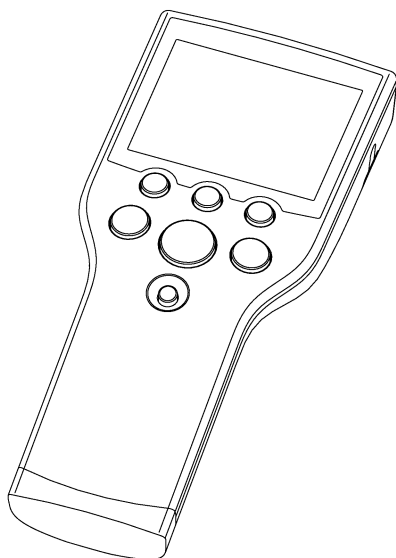

沪制 01040055 号

使用说明

Operating Instructions



SevenGo™
SG2 pH 计 / pH meter SG2

METTLER TOLEDO

A graphic element consisting of a series of parallel, slightly curved lines that create a sense of motion or a stylized arrow pointing towards the right, positioned behind the company name.

目录页码

1.	简介	3
2.	安全措施	3
3.	安装	5
3.1	电池安装/拆卸	5
3.2	腕带安装	5
3.3	SevenGo™ 电极夹 (选件)	6
3.4	野外手提箱 (选件)	6
3.5	ErGo™ 野外助手 (选件)	7
4.	SG2标准型pH计操作	8
4.1	显示与按键	8
4.2	校准	10
4.2.1	缓冲溶液组	10
4.2.2	选择一组预置缓冲溶液组	10
4.2.3	设置一组用户自定义缓冲溶液组	10
4.2.4	一点校准	11
4.2.5	两点校准	11
4.2.6	三点校准	11
4.3	样品测量	12
4.3.1	pH 测量	12
4.3.2	mV 测量	12
4.4	温度测量	12
4.4.1	自动温度补偿	12
4.4.2	手动温度补偿	12
4.5	使用存储器	13
4.5.1	存储读数	13
4.5.2	调取存储数据	13
4.5.3	清除存储数据	13
4.6	仪表自检	13
4.7	出错信息	14
5.	维护	15
5.1	仪表维护	15
5.2	电极维护	15
5.3	废弃物处理	15
6.	选配件	16
7.	技术指标	17
8.	附录	18
8.1	缓冲液组	18
8.2	误差限	19

1. 简介

非常感谢您购买梅特勒-托利多公司的高品质便携式仪表，拥有SevenGo™系列便携式仪表，您就真正实现了移动的电化学实验室，而这正是我们一贯的追求。

SevenGo™系列便携式仪表远不仅仅是一系列高性价比的便携式仪表，同时它还具有以下诸多卓越的新特点：

- 符合IP67等级，包括仪表、传感器和连接器
- 易于操作，操作手册会给您提供清楚易懂的操作指南
- 卓越的人体工效学设计，使仪器与人体仿佛浑然一体
- 可选的设备定期认证服务，确保实验测量始终精确无误
- 诸如电极夹、防护罩、新型可洗手提箱以及附加野外助手等有用附件是工厂以及野外使用的所有便携式仪表的最佳辅助设备

2. 安全措施

操作人员防护措施



- 切勿在有爆炸危险的环境中工作！因为仪表壳体并非气密型（可能因火花形成或者侵入气体引起的腐蚀而产生爆炸危险）。



- 使用化学品和溶剂时，请遵照供应商提供的操作指南和实验室安全规程进行操作！

操作人员操作安全预防措施



- 禁止将仪器的壳体分离。
- 仅允许梅特勒-托利多服务人员维修仪表！
- 请避免下列环境因素的影响：
 - 剧烈的震动
 - 长期处于日照下
 - 大气湿度超过85%
 - 存在腐蚀性气体
 - 环境温度低于5 °C 或者超过40 °C
 - 强电场或磁场下
 - 海拔高于4000m

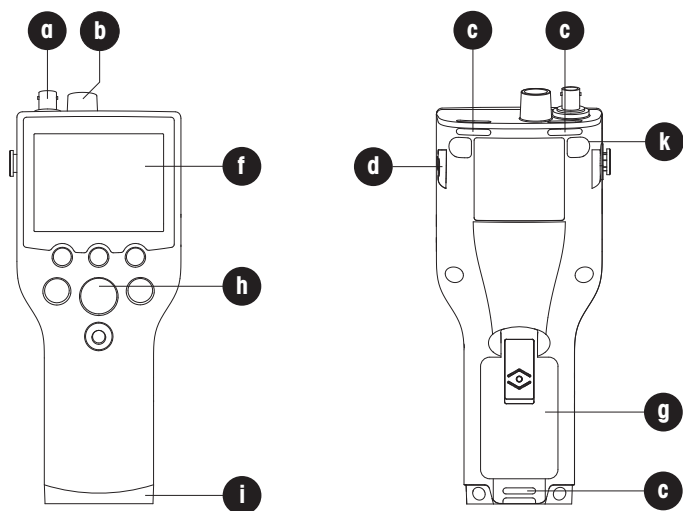

a BNC信号输入插孔

b Cinch温度输入插孔

c 腕带安装槽

d SevenGo™电极夹安装位 (仪表两侧)

f 显示屏

g 电池盖 (51302328)

h 橡胶按键

i 蓝色底盖(51302324)及野外助手安装位

k 橡皮垫安装位

3. 安装

小心开箱取出仪表。将校准证书存放在安全位置。

3.1 电池安装/拆卸

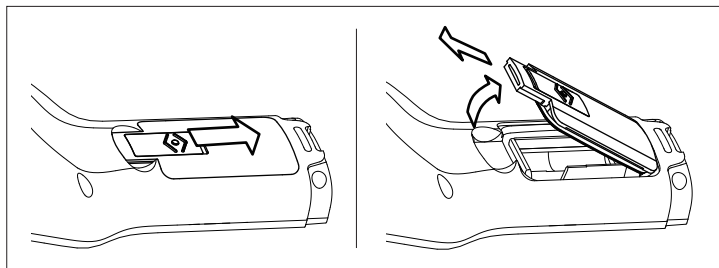

1. 向下推电池盖上的按钮，用2个手指捏住电池盖并取下；
2. 按仪表电池盒中的标识将电池插入电池盒中；或者用手指按住电池正极取出电池；
3. 合上电池盖，并向上推按钮以固定电池盖。

注

IP67等级要求电池盒具有良好的密封性。当电池盖周边的O型圈破损时，请及时更换。（SevenGo™密封套件订购号51302336）

3.2 腕带安装

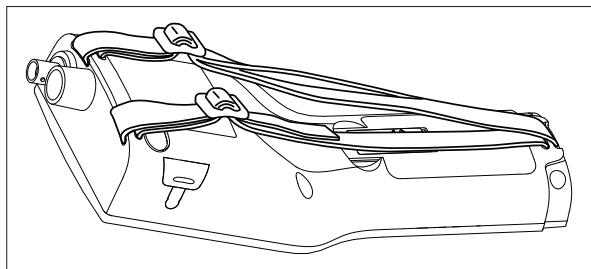

根据图示安装妥当腕带

3.3 SevenGo™电极夹（选件）

SevenGo™电极夹（51302325）是一个电极的固定装置，可以安装在仪表外壳的任意一侧。首先将电极夹固定位上的盖子去掉，可以用拇指将盖子推开，之后将电极夹按进凹陷处。可以将电极从夹子的上方插进去，并根据工作和存储的需要使电极绕夹子旋转。

3.4 户外便携箱（选件）

户外便携箱（51302359）并不仅仅是一种携带测量设备的装置，它还可以用作一种理想的便携式工作站。在测量过程中可以将仪表放在便携箱中。

现场成套附件（51302360），电极夹，防护罩和腕带使操作变得十分简单。

3.5 ErGo™野外助手(选件)

ErGo™(51302320)能保护仪表免遭冲击并可安全地保护电极。对于在工厂或是野外测量，它都是一个完美的附件。若放在工作台或地上可以舒适地操作。

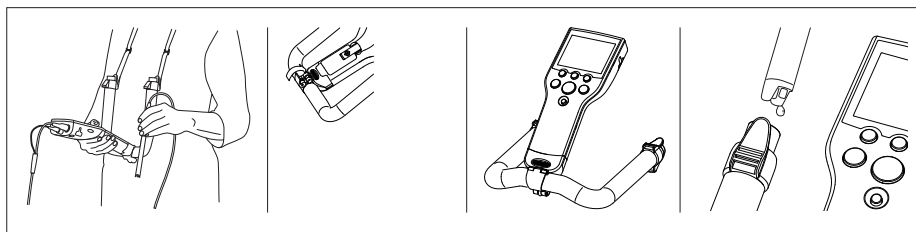

1. 卸下仪表端部上的底盖 (51302324)
2. 将ErGo™适配器拧到仪表上 (51302337)
3. 根据显示的图安装ErGo™
4. 将背带装到ErGo™的两端上。(51302321)

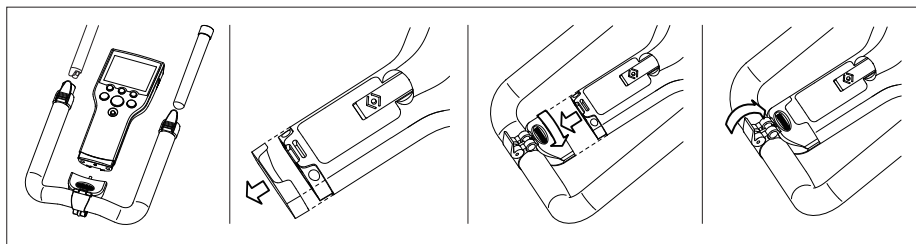

4. SG2标准型pH计操作

4.1 显示与按键

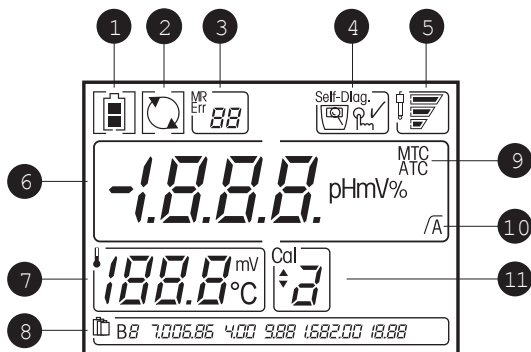

- 1 电池状态,指示电池电量是全满、半满还是空(更换电池参阅3.1节)
- 2 连续测量功能被激活(禁止自动关机功能)。仪表的默认设置是十五分钟后自动关机。当再次开/关机后,自动关机功能再次被激活。
- 3 存储数据编号/错误索引(存储器使用参阅4.5节/错误索引参阅4.7节)



错误索引



存储在存储器中的数据总数



检索存储器

4 仪表自检(见4.6)



仪表
自检图标



按键
提示



自检
通过

5 电极状态(电极维护见5.2)



斜率:95-105 %
零电位:±(0-15) mV
电极状态良好



斜率:90-94 %
零电位:±(15-35) mV
电极需要清洁



斜率:85-89 %
零电位:±(>35) mV
电极出故障

6 pH/mV 读数

7 测量过程中的温度或校准过程中的零点值

8 缓冲液组(见4.2)

9 自动/手动温度补偿(见4.4)









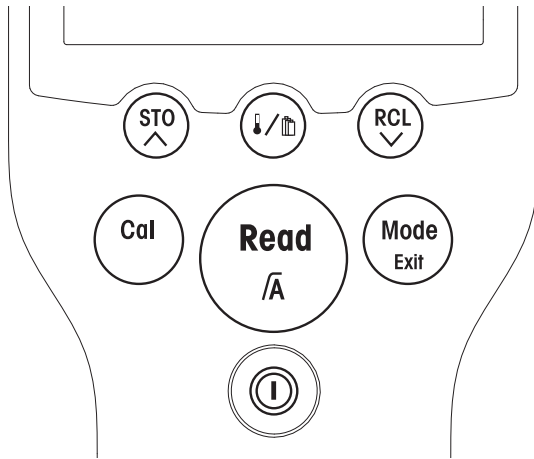

10 读数稳定图标/自动终点图标

厂 读数稳定图标

A 自动终点图标

11 校准点显示



	按下并释放 	按住持续2秒钟 
	- 仪表开/关	- 接通/断开连续测量
	- 开始测量 - 返回测量模式 - 确认设置, 存储输入的值	- 开启/关闭自动终点测量 $\sqrt{\quad} / \sqrt{\quad}$
	- 开始校准	
	- 在pH和mV测量模式间切换 - 返回测量 (忽略输入)	
	- 设置MTC温度值	- 选择或编辑校准溶液组
	- 将当前结果存储到存储器中 - 在设置时增大值 - 向上滚动菜单	
	- 检索存储的数据 - 在设置时减小值 - 向下滚动菜单	- 浏览最近校准数据
	- 启动仪表自检	

4.2 校准

4.2.1 缓冲溶液组

SevenGo™ SG2标准型pH计可进行1, 2和3点校准。如果您从仪表中预设的四个固定组中选择校准缓冲液组, 则缓冲液在校准过程中将被自动识别(自动识别缓冲液)。

4个预设缓冲液组是:

B1	7.00	4.00	10.01	1.68		(25 °C)
B2	7.00	4.01	9.21	2.00	11.00	(25 °C)
B3	7.00	4.00	9.00	2.00	12.00	(20 °C)
B4	6.86	4.01	9.18	1.68		(25 °C)

对于每一组缓冲液, 自动温度补偿程序都已固化在仪表中(见附录)。

您还可以按照下述缓冲液设置步骤来自行设置缓冲液组, 但在此情况下, 自动识别缓冲液功能在校准过程中将不起作用。

4.2.2 选择一组预置缓冲溶液组

连续按 \downarrow/\uparrow 键直到当前缓冲液组闪烁。

用 \wedge 或 \vee 键选择其他组。当所需的缓冲液组闪烁时, 按 **Read** 以确认选择。

4.2.3 设置一组用户自定义缓冲溶液组

连续按 \downarrow/\uparrow 键直到当前缓冲组闪烁, 用 \wedge 或 \vee 键选择 **B5**。

按 **Read** 以开始设置。仪表显示当前温度设定值并且此点和显示屏闪烁(默认温度为25 °C)。

用 \wedge 或 \vee 键修改值。按 **Read** 以存储值并继续操作。

在设置温度值后, 仪表显示第一个校准缓冲液的当前设置(默认值 4.00)。

用 \wedge 或 \vee 键修改值。按 **Read** 以存储值并继续操作。

在设置好第一个校准缓冲液后, 按 **Cal** 以开始设置下一个点。

其余设置步骤与第一点相同。您可以设置三个自定义的校准缓冲液。

完成设置后, 按 **Read** 以退出。

注

当在校准时使用用户自定义缓冲液组时, 屏幕将显示你所设置的缓冲值。确保使用正确的缓冲液。

另外还应使缓冲液温度保持在设定值上。使用温度探头时, 如果测定的温度比设定值高1 °C, 屏幕显示Err 5。

4.2.4 一点校准

4.2.4.1

将电极放在一个校准缓冲液中并按 **Cal** ,在信号稳定后仪表根据预选终点方式自动终点(显示屏显现 \sqrt{A})或按 **Read** 手动终点(显示屏显现 $\sqrt{\quad}$)。仪表将显示并锁定至相应缓冲液值,同时零点和斜率也会显示。

4.2.4.2

按 **Read** 即可确认这次校准并返回测量模式。如果需要取消这次校准,按 **Exit** 即可。

注

当进行一点校准时,只有零点被调节。如果电极之前进行过多点校准,它的斜率会被使用。否则理论斜率(59.16 mV/pH)被采纳。

4.2.5 两点校准

第1步 按4.2.4.1所述执行第一点校准,仪表自动终点或手动终点后,请不要按 **Read** 键,否则将返回测量模式。

第2步 用去离子水冲洗电极。

第3步 将电极放在下一个校准缓冲液中并按 **Cal**。

在信号稳定后仪表根据预选终点方式自动终点或按 **Read** 手动终点。仪表将显示并固定相关缓冲液值,更新电极零点并显示从两个校准点计算得来的新斜率。

确定这次校准并返回样品测量,按 **Read** 即可。如果需要取消这次校正,按 **Exit**。

4.2.6 三点校准

执行与“两点校准”中相同的步骤,然后重复第2步和第3步来校准第三校准点。

注

推荐使用温度传感器或带内置温度传感器的电极。如果使用MTC模式,则应将所有缓冲液和样品溶液保持在相同的设定温度上。

为了确保最精确的pH读数,应定期执行校准。

4.3 样品测量

4.3.1 pH 测量

将电极放在样品中并按 **Read** 以开始测量: 小数点闪动。
显示屏显示样品的pH值。自动测量终点 **A** 是仪表的默认设置。
当传感器输出稳定后, 显示屏自动固定, 并显现 \sqrt{A} 。

按住 **Read** 键, 可以在自动和手动测量终点模式之间切换。要手动测量一个终点, 可按 **Read** 显示屏固定并显现 \sqrt{A} 。

pH测量和mV测量稳定性判据是: 如果信号变化在5秒内小于0.1 mV仪表将测量终点。

4.3.2 mV 测量

要在pH 测量过程中查看mV值, 只要按 **Mode** 即可。
要执行 mV 测量, 请按与pH 测量相同的步骤执行。

4.4 温度测量

4.4.1 自动温度补偿

为了提高精度, 我们建议使用一个内置或独立温度探头。当使用温度探头时, 将显示ATC符号和样品温度。

注

本仪表可适用 NTC 30 k Ω 温度探头。

4.4.2 手动温度补偿

当仪表未检测到温度探头时, 它将自动切换为手动温度补偿模式, 并显现 **MTC**。要设定MTC温度, 按 \downarrow/\uparrow 键, 用 \wedge 和 \vee 来增大或减小样品的温度值。按 **Read** 键以确认你的设置。默认设置值25 °C。

4.5 使用存储器

4.5.1 存储读数

SevenGo™标准型pH计 SG2 可以存储多达 30个终点测量结果。当测量结束时按 **STO** 存储一次读数。**M01** 表示存储了一个测量结果, **M30** 表示存储了最多30个测量结果。

如果您在显示 **M30** 时按 **STO**, **FUL** 表示存储器已存满。要存储数据就必须清除存储器。(参见下文)

4.5.2 调取存储数据

当测量结束时按 **RCL** 可从存储器中检索已存储的值。

按 **^** 和 **v** 以滚动显示存储的结果。

R01 至 **R30** 表示显示的是哪一个结果。

按 **Read** 可退出。

4.5.3 清除存储数据

当按 **^** 或 **v** 以滚动显示存储的结果时, 将会看到 **MRCL** 按 **Read**, 然后 **CLr** 闪烁, 按 **Read** 以确认你想清除存储器。或可以按 **Exit** 取消清除操作并返回测量模式。

4.6 仪表自检

同时按住 **Read** 和 **Cal** 直到图标 **Self-Diag** 显现。

首先仪表满屏显示所有图标, 然后依次闪烁每一个图标。这样可以检查所有的图标是否被正确显示。最后一步是检测每一个按键是否功能正常。检测按键时需要用户按相应的按键。

当  图标闪烁时, 有七个图标显示在屏幕上, 要求用户以任意次序一个接一个按键盘上的七个功能键: 按一个键后, 屏幕上的对应图标即消失; 继续按其按键直到所有图标均消失。

自检完成时, 会显现一个  图标。如果自检失败, 将显现“Err 1”(参阅)。

注

必须在两分钟之内按完所有七个按键, 否则将显示“Err 1”并需要重新执行该过程。

4.7 出错信息

Err 1	自检失败	重复自检步骤并确保你在两分钟内按完七个按键。如果“Err 1”仍然显现，请联系梅特勒-托利多公司技术服务人员。
Err 2	测量值超出范围	请检查电极润湿帽是否取下，电极连接是否正确并放入待测溶液中。 如果仪表未连接电极，请将短路夹插入插座。
Err 3	测定缓冲液温度超出范围 (5...50 °C)	使缓冲液温度保持在规定的范围内。
Err 4	电极零电位超出范围	请确认你使用的缓冲液正确并新鲜。 清洁或更换电极。
Err 5	电极斜率超出范围	请确认你使用的缓冲液正确并新鲜。 清洁或更换电极。
Err 6	仪表不能识别缓冲液	请确认你使用的缓冲液正确并新鲜。 检查在校准过程中你是否重复使用同一种缓冲液。
Err 7	在设置自定义缓冲液时数据输入错误	输入自定义的缓冲值，仪表不接受其pH值小于其他预置值一个pH单位的值。重新输入一个值。
Err 8	ATC测定温度与用户自定义的温度值不同	使缓冲液温度保持在设定温度上或更改温度设定值。
Err 9	当前数据已被存储一次	一个测量结果只能存储一次。执行新的测量存储新的数据。

5. 维护

5.1 仪表维护

禁止将仪器的壳体分离。

除了偶尔需要用一块湿布擦拭一下外，SevenGo™系列仪表不需要作其他维护保养。

外壳由(ABS/PC)塑料制成，会受到一些有机溶剂如甲苯、二甲苯和丁酮(MEK)等的侵蚀。如出现上述情况，立即擦去溅到外壳上的此类溶剂。

5.2 电极维护

确保电极始终存放在适当的存储液中。

为了获得最大精度，任何附着或凝固在电极外部的填充液均应用蒸馏水及时除去。

请始终根据厂商规定存放电极，不要使之干涸。

如果电极斜率迅速下降，或者响应速度缓慢，则可用下列步骤解决。根据样品的不同，请尝试下列方法之一

1. 对于油脂类，请用蘸有丙酮或肥皂水的原棉除去电极膜表面的污垢。
2. 如果电极膜干涸，将电极头浸入0.1 M HCl溶液中，放置一夜。
3. 如果在隔膜中有蛋白质积聚，请将电极浸入HCl/胃蛋白酶溶液中除去沉积物(定货号 51340068)。
4. 如果电极发生硫化银污染，请将电极浸入硫脲溶液中除去沉积物(定货号51340070)。

电极处理后请重新校准。

注意

请按毒性或腐蚀性物质的处理条例来处理清洗液或填充液。

5.3 废弃物处理

根据欧洲报废电子电气设备(WEEE)指令(2002/96 EG)的要求,本设备不得与生活垃圾一同处理。依据各国现行法规,这也适用于非欧盟国家。



请根据当地规定将本产品送往专门适于电子电气设备的回收站处理。

如有疑问请咨询主管部门或您购买本设备的代理商。

转让本设备时(例如继续用于个人或工商业用途)请将本规定的内容一并转达。

非常感谢您对环境保护所做的贡献。

6. 选配件

	订货号
SevenGo pro™ pH/ORP /离子计 SG8	
SevenGo™ 电导率仪 SG3	
SevenGo pro™ 电导率仪 SG7	
SevenGo pro™ 溶氧仪 SG6	
InLab®413 SG (IP67) 3合1 pH 电极, PEEK电极杆	51340288
InLab®413 SG/10m (IP67) 3合1 pH电极, PEEK电极杆	51340289
LE438 3合1 pH电极, 环氧树脂杆	51340242
ErGo™ (包括适配器和电极管)	51302320
ErGo™ 电极管	51302323
手提箱(空)	51302359
现场附件套件	51302360
防护罩(3个)	51302326
瓶子	51300240
腕带	51302331
电池盖	51302328
蓝色端盖	51302324
SevenGo™ 固定夹	51302325
固定夹盖	51302327
SevenGo™ 密封套件	51302336
橡胶支脚(2个)	51302335
野外工作电极支架	51302334
BNC短路插头	51302859
pH测量指南(Guide to pH measurement)	51300047
pH 4.01 缓冲液袋, 30 x 20 mL	51302069
pH 4.01 缓冲液, 6 x 250 mL	51340058
pH 7.00 缓冲液袋, 30 x 20 mL	51302047
pH 7.00 缓冲液, 6 x 250 mL	51340060
pH 9.21 缓冲液袋, 30 x 20 mL	51302070
pH 9.21 缓冲液, 6 x 250 mL	51300194
pH 10.01 缓冲液袋, 30 x 20 mL	51302079
pH 10.01 缓冲液, 6 x 250 mL	51340231
组合缓冲液(每箱, 10 x 20 mL, 4.01/7.00/9.21)	51302068
组合缓冲液(每箱, 10 x 20 mL, 4.01/7.00/10.01)	51302080
HCl/胃蛋白酶溶液(清除蛋白质污染)	51340068
硫脲溶液(清除硫化银污染)	51340070
pH 电极的活化液	51340073

7. 技术指标

	标准型
测量范围	pH 0.00...14.00
温度	-1999...1999 mV
分辨率	-5 °C...105 °C
	0.01 pH
	1 mV
	0.1 °C
误差极限	± 0.01 pH
	± 1 mV
	± 0.5 °C
pH校准	1,2,或3点
等电位点	pH 7.00
标准缓冲液	4个固定组
	3个用户自定义缓冲液
电源要求	额定值 6 V DC, 5 mA
	电池 4 x AA/LR6, 1.5 V
	或 NiMH, 1.2 V 可充电的
尺寸/重量	220 x 90 x 45 mm / 0.33 kg
显示器	液晶显示器
pH输入	BNC (IP67), 阻抗 > 10 ¹² Ω
温度输入	Cinch (IP67), NTC 30 kΩ
IP等级	IP67
电池寿命	> 500 小时
环境条件	环境温度 5...40 °C
	相对湿度 5%...80% (不冷凝)
	安装类别 II
	污染等级 2
材料	外壳 ABS/PC 增强型
	窗口 聚甲基丙烯酸甲酯 (PMMA)
	按键 硅橡胶

8. 附录

8.1 缓冲液组

SevenGo™ pH 仪表用下表中列出的值来修正缓冲液pH的值。

缓冲液组 1 (参比温度25 °C) MT US

5	7.09	4.00	10.25	1.67
10	7.06	4.00	10.18	1.67
15	7.04	4.00	10.12	1.67
20	7.02	4.00	10.06	1.68
25	7.00	4.00	10.01	1.68
30	6.99	4.01	9.97	1.68
35	6.98	4.02	9.93	1.69
40	6.97	4.03	9.89	1.69
45	6.97	4.04	9.86	1.70
50	6.97	4.06	9.83	1.71

缓冲液组 2 (参比温度25 °C) MT Europe

5	7.09	4.01	9.45	2.02	11.72
10	7.06	4.00	9.38	2.01	11.54
15	7.04	4.00	9.32	2.00	11.36
20	7.02	4.00	9.26	2.00	11.18
25	7.00	4.01	9.21	2.00	11.00
30	6.99	4.01	9.16	1.99	10.82
35	6.98	4.02	9.11	1.99	10.64
40	6.97	4.03	9.06	1.98	10.46
45	6.97	4.04	9.03	1.98	10.28
50	6.97	4.06	8.99	1.98	10.10

缓冲液组 3 (参比温度20 °C) Merck

5	7.07	4.04	9.16	2.01	12.41
10	7.05	4.02	9.11	2.01	12.26
15	7.02	4.01	9.05	2.00	12.10
20	7.00	4.00	9.00	2.00	12.00
25	6.98	4.01	8.95	2.00	11.88
30	6.98	4.01	8.91	2.00	11.72
35	6.96	4.01	8.88	2.00	11.67
40	6.95	4.01	8.85	2.00	11.54
45	6.95	4.01	8.82	2.00	11.44
50	6.95	4.00	8.79	2.00	11.33

缓冲液组 4 (参比温度25 °C) JIS Z 8802

5	6.95	4.00	9.40	1.67
10	6.92	4.00	9.33	1.67
15	6.90	4.00	9.28	1.67
20	6.88	4.00	9.22	1.68
25	6.86	4.01	9.18	1.68
30	6.85	4.02	9.14	1.68
35	6.84	4.02	9.10	1.69
40	6.84	4.04	9.07	1.69
45	6.83	4.05	9.04	1.70
50	6.83	4.06	9.01	1.71

8.2 误差限

讯息	描述	不可接受范围
Err 2	超出范围	pH: < 0.00 或 > 14.00 mV: < -1999 或 > 1999
Err 3	缓冲液温度超出范围	T [°C]: < 5 或 > 50
Err 4	电极零电位超出范围	Eref1-Eb > 60 mV
Err 5	电极斜率超出范围	Eref1-Eb > 60 mV
Err 6	缓冲液错误	ΔEref1 < 10 mV
Err 7	无效的用户自定义缓冲液	ΔpH < 1 pH
Err 8	ATC 测定温度不同于自定义温度	t _{ATC} - t _{buffer} > 1 °C

Contents

1.	Introduction	3
2.	Safety measures	3
3.	Installation	5
3.1	Installing / removing the batteries	5
3.2	Fitting the wrist strap	5
3.3	SevenGo™ clip (optional)	6
3.4	Field carry case (optional)	6
3.5	ErGo™ field assistant (optional)	7
4.	Operating the SG2 pH meter	8
4.1	Display and key controls	8
4.2	Calibration	10
4.2.1	Buffer groups	10
4.2.2	Selecting a predefined buffer group	10
4.2.3	Setting up a user-defined buffer group	10
4.2.4	Performing a 1-point calibration	11
4.2.5	Performing a 2-point calibration	11
4.2.6	Performing a 3-point calibration	11
4.3	Sample measurement	12
4.3.1	Performing a pH measurement	12
4.3.2	Performing a mV measurement	12
4.4	Temperature measurement	12
4.4.1	Automatic temperature compensation	12
4.4.2	Manual temperature compensation	12
4.5	Using the memory	13
4.5.1	Storing a reading	13
4.5.2	Recalling from memory	13
4.5.3	Clearing the memory	13
4.6	Self-diagnosis	13
4.7	Error messages	14
5.	Maintenance	15
5.1	Meter maintenance	15
5.2	Electrode maintenance	15
5.3	Disposal	15
6.	Accessories	16
7.	Specifications	17
8.	Appendix	18
8.1	Buffer tables	18
8.2	Error Limits	19

1. Introduction

Thank you for purchasing this high quality METTLER TOLEDO portable meter. Electrochemistry in motion – that is our motto. And with the SevenGo™ portable line we really mean it.

SevenGo™ is much more than just a series of portable meters with an excellent price/performance ratio. It is an ingenious concept that includes many exciting new features:

- IP67 rating: this applies to the instrument itself as well as to the sensors and the connections;
- optimum ease of use, making the operating instructions primarily a source of reference;
- excellent ergonomics – as if the instrument were part of you;
- option for regular equipment qualification, giving you full confidence that your measurement results are always accurate;
- useful accessories such as the electrode clip, the protecting cover, the new washable carry case, as well as the optional field assistant, ErGo™ – the ultimate aid for all measurements in the plant as well as in the field.

2. Safety measures

Measures for your protection



- Never work in an environment subject to explosion hazards! The housing of the instrument is not gas tight (explosion hazard due to spark formation, corrosion caused by the ingress of gases).



- When using chemicals and solvents, comply with the instructions of the producer and the general lab safety rules!

Measures for your operational safety



- Do not unscrew the two halves of the housing.
- Have the instrument serviced only by METTLER TOLEDO Service!
- Exclude the following environmental influences:
 - powerful vibrations,
 - direct sunlight,
 - atmospheric humidity greater than 80%,
 - corrosive gas atmosphere,
 - temperatures below 5 °C and above 40 °C,
 - powerful electric or magnetic fields;
 - altitude above than 4000m!

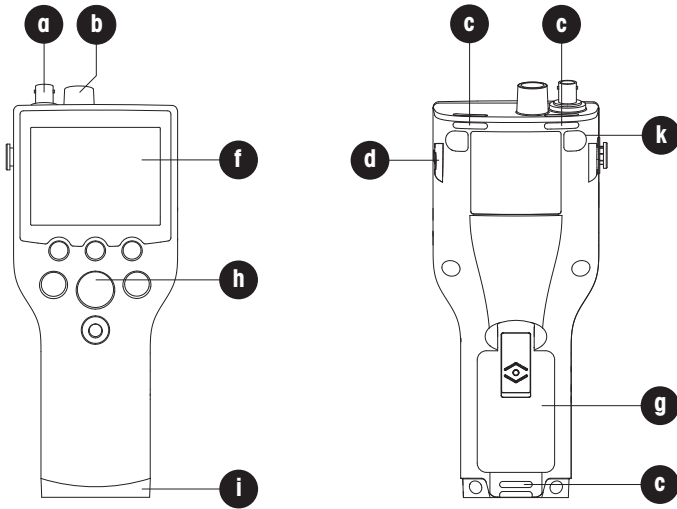

a BNC socket for mV/pH signal input

b Cinch socket for temperature signal input

c Slots for attaching the wrist strap

d Fixing points for SevenGo™ clip (on both sides of the meter)

f Display

g Battery cover (51302328)

h Rubber key pad

i Bottom cap (51302324) blue cover over the field assistant's fixing point

k Rubber feet fixing points

3. Installation

Carefully unpack the meter. Keep the calibration certificate in a safe place.

3.1 Installing / removing the batteries

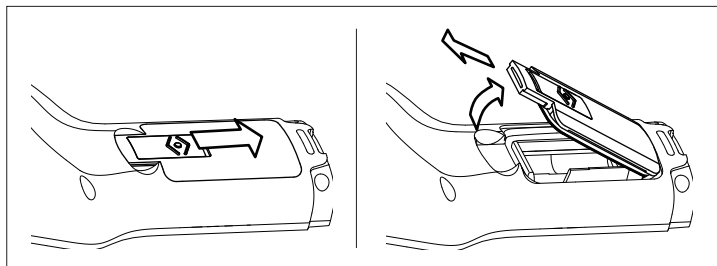

1. Push the button on the Battery cover in the direction of the arrow, hold the lid with two fingers and remove it;
2. Insert the batteries in the battery compartment, as shown; remove the batteries from the battery compartment;
3. Replace the Battery cover, and push back the button to fix the lid in place.

Note

The IP67 rating requires the battery compartment to be perfectly sealed. The sealing ring around the Battery cover must be replaced if it is damaged in any way (SevenGo™ Sealing Kit, 51302336).

3.2 Fitting the wrist strap

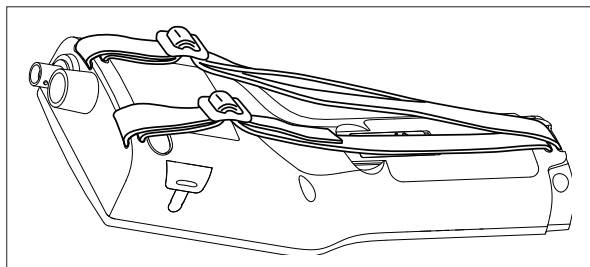

Fit the wrist strap as shown in the diagram.

3.3 SevenGo™ clip (optional)

The SevenGo™ Clip (51302325) is an electrode holder that can be placed next to the display on either side of the housing. To mount the clip, remove the cover over the clip's fixing point using your thumbnail. Then attach the clip by pressing it into the recess. Slide the shaft of the sensor into the clip from top. You can switch between the storage and working positions by rotating the sensor around the clip's axis.

3.4 Field carry case (optional)

The portable carry case (51302359) is not just a device for transporting your measuring equipment, it is also ideal for use as a portable workbench. The meter can be placed in the carry case during the measurement.

The field accessory kit (51302360) with electrode clip, protective cover and wrist strap completes your equipment. It allows you to make full use of the different possibilities offered by the system and facilitates operation.

3.5 ErGo™ field assistant (optional)

The ErGo™ (51302320) protects your instrument from shocks and allows you to safely store your electrode(s). It is the perfect accessory for carrying and measuring in the plant or field, and for working comfortably when the meter is placed on a table or on the ground.

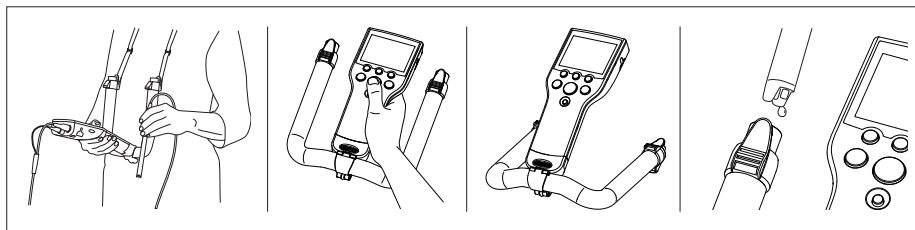

1. Remove the blue bottom cap (51302324) at the base of the meter;
2. Screw the ErGo™ adapter (51302337) onto the meter;
3. Mount the ErGo™ as shown;
4. Fit the neck strap (51302321) to both ends of the ErGo™.

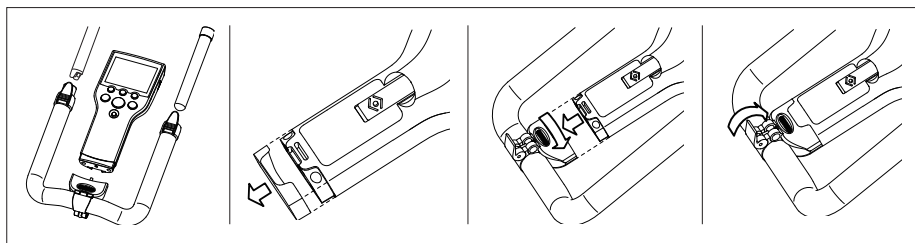

4. Operating the SG2 pH meter

4.1 Display and key controls

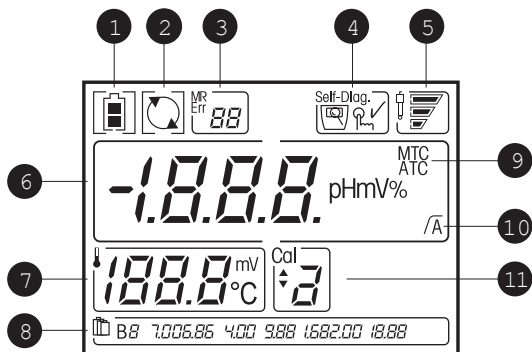

1 Battery status shows the condition of the batteries – fully charged, half-charged or fully discharged. (To replace batteries, see Section 3.1)

2 Auto-off override, in default operation, the meter switches itself off after 15 minutes to prolong battery life. After switching off/on, the auto-off is active again

3 Memory number / Error index (for use of memory see Section 4.5 / Error messages are described in Section 4.7)



Error index



Number of data sets stored in memory



Recall memory

4 Meter self-diagnosis (see Section 4.6)



Self-diagnosis indicator



Indication to press key



Self-diagnosis passed

5 Electrode condition (for electrode maintenance see Section 5.2)



Slope: 95-105%
Offset: $\pm(0-15)$ mV
Electrode is in good condition



Slope: 90-94%
Offset: $\pm(15-35)$ mV
Electrode needs cleaning



Slope: 85-89%
Offset: $\pm(>35)$ mV
Electrode is faulty

6 pH/mV reading

7 Temperature during measurement or offset value in calibration process

8 Buffer groups (see Section 4.2)

9 Auto/Manual temperature compensation (see Section 4.4)









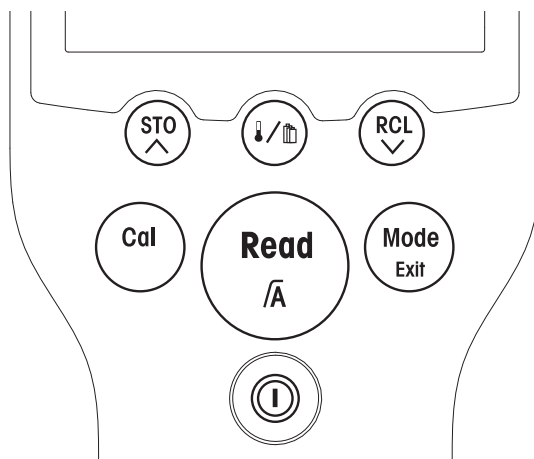

10 Endpoint stability/auto endpoint

Endpoint stability

A Auto endpoint

11 Calibration point



	Press and release 	Press and hold for 2 seconds 
	<ul style="list-style-type: none"> - Meter on/off 	<ul style="list-style-type: none"> - Switch on/off auto-off override (switches off the meter after 15 minutes)
	<ul style="list-style-type: none"> - Start or endpoint measurement - Return to measurement mode - Confirm setting; store entered value 	<ul style="list-style-type: none"> - Turn auto endpoint on/off $\sqrt{\quad} / \bar{A}$
	<ul style="list-style-type: none"> - Start calibration 	
	<ul style="list-style-type: none"> - Switch between pH and mV measuring modes - Back to measurement (ignore the input) 	
	<ul style="list-style-type: none"> - Set MTC 	<ul style="list-style-type: none"> - Select or edit buffer group
	<ul style="list-style-type: none"> - Store current reading to memory - Increase value during setting - Scroll up through the memory 	
	<ul style="list-style-type: none"> - Recall stored data - Decrease value during setting - Scroll down through the memory 	<ul style="list-style-type: none"> - Review the latest calibration data
	<ul style="list-style-type: none"> - Start meter self-diagnosis  	

4.2 Calibration

4.2.1 Buffer groups

The SevenGo™ SG2 pH meter allows you to perform 1-, 2- and 3-point calibrations. If you select your calibration buffer group from one of the four predefined groups defined in the meter, the buffers are automatically recognized and displayed during calibration (auto buffer recognition).





The four predefined buffer groups are:

B1	7.00	4.00	10.01	1.68		(at 25 °C)
B2	7.00	4.01	9.21	2.00	11.00	(at 25 °C)
B3	7.00	4.00	9.00	2.00	12.00	(at 20 °C)
B4	6.86	4.01	9.18	1.68		(at 25 °C)







Tables (B1...B4) for automatic temperature compensation are programmed in the meter (see also Appendix).



You can also follow the buffer setting procedure described below to define your own buffer group, but in this case auto buffer recognition does not work during calibration.

4.2.2 Selecting a predefined buffer group

Press and hold / until the current buffer group blinks. Use  or  to select another buffer group. When the desired buffer group blinks, press **Read** to confirm your selection.

4.2.3 Setting up a user-defined buffer group

Press and hold / until the current buffer group blinks. Use  or  until  B5 appears to start setting the values. Press **Read** to confirm the selection. The meter displays your current temperature setting and the unit and frame blink (default temperature is 25 °C). Use  or  to change the value. Press **Read** to store the value and continue.

After setting the temperature value, the meter displays the current setting of the first calibration buffer (default value 4.00). Use  or  to change the buffer value. Press **Read** to store the value and continue.

After setting the first calibration buffer, press **Cal** to set the next calibration buffer.

The procedure is the same as for the first point. You can set up to three user-defined calibration buffers. When you have completed your settings, press **Read** to exit.

Note

When using a user-defined buffer group in the calibration, the screen will display the buffer value you set. Make sure that you use the correct buffer.

For user-defined buffers, there is no buffer table programmed in the meter. Therefore you should always keep the buffer temperature at the set value. When using a temperature probe, if the temperature measured differs by more than 1 °C from the set value, Err 5 appears.

4.2.4 Performing a 1-point calibration

Place the electrode in a calibration buffer and press **Cal**. The SG2 endpoints according to the preselected endpoint mode after the signal has stabilized or after pressing **Read** the meter displays and freezes the relevant buffer value. The offset value and the slope are then shown on the display.

To accept the calibration and return to sample measurement, press **Read**. To reject the calibration, press **Exit**.

Note

With the 1-point calibration only the offset is adjusted. If the sensor was previously calibrated with multi-point calibration the previously stored slope will remain. Otherwise the theoretical slope (59.16 mV / pH) will be used.

4.2.5 Performing a 2-point calibration

- Step 1 Perform the first point calibration as described above in "Performing a 1-point calibration".
- Step 2 Rinse the electrode with deionized water.
- Step 3 Place the electrode in the next calibration buffer and press **Cal**.

The SG2 endpoints according to the preselected endpoint mode after the signal has stabilized or after pressing **Read**. The meter displays and freezes the relevant buffer value, updates the electrode offset and shows the new slope calculated from the two calibration points.

To accept the calibration and return to sample measurement, press **Read**. To reject the calibration, press **Exit**.

4.2.6 Performing a 3-point calibration

Perform the same steps as described above in "Performing a 2-point calibration", and then repeat steps 2 and 3 for the third calibration point.

Note

The use of a temperature sensor or electrode with a built-in temperature sensor is recommended. If you use the MTC mode, you should enter the correct temperature value and keep all buffer and sample solutions at the set temperature.

To ensure the most accurate pH readings, you should perform a calibration regularly.

4.3 Sample measurement

4.3.1 Performing a pH measurement

Place the electrode in the sample and press **Read** to start the measurement: the decimal point blinks. The display shows the pH of the sample. The automatic endpoint **A** is the default setting of the meter. When the signal has stabilized, the display freezes automatically, and **√A** appears.

By pressing and holding down **Read**, you can switch between the auto and manual endpoint modes. To manually endpoint a measurement, press **Read**: the display freezes and **√** appears.

Stability criterion for pH and mV measurement – The signal of the sensor input must not change by more than 0.1 mV in 5 seconds.

4.3.2 Performing a mV measurement

To switch to mV mode, press **Mode**.

To perform a mV measurement, follow the same procedure as for pH measurement.

4.4 Temperature measurement

4.4.1 Automatic temperature compensation

For better accuracy, we recommend the use of either a built-in or a separate temperature probe. If a temperature probe is used, **ATC** and the sample temperature are displayed.

Note

The meter accepts NTC 30 kΩ temperature sensors.

4.4.2 Manual temperature compensation

If the meter does not detect a temperature probe, it automatically switches to the manual temperature compensation mode and **MTC** appears.

To set the MTC temperature, press **↓/↑** and use **∧** and **∨** to increase or decrease the value to the temperature of your sample. Press **Read** to confirm your setting. The default setting is 25 °C.

4.5 Using the memory

4.5.1 Storing a reading

The SevenGo™ SG2 pH meter can store up to 30 end-pointed results. Press **STO** when the measurement has endpointed. **M01** indicates that one result has been stored, and **M30** that the maximum of 30 results have been stored.

If you press **STO** when **M30** is displayed, **FUL** indicates that the memory is full. To store further data you will have to clear the memory (see below).

4.5.2 Recalling from memory

Press **RCL** to recall the stored values from memory when the current measurement has end-pointed.

Press **^** or **v** to scroll through the stored results. **R01** to **R30** indicate which result is being displayed. Press **Read** to exit.

4.5.3 Clearing the memory

Continue pressing **^** or **v** to scroll through stored results until **MRCL** appears. Then press **Read**, **CLr** blinks; Press **Read** again to confirm the deletion or press **Exit** to return to measurement mode without deletion of the data.

4.6 Self-diagnosis

Press and hold **Read** and **Cal** simultaneously until the meter **Self-Diag** icon appears.

The meter displays the full screen first, then each icon blinks one after the other. This way you may check whether all icons are correctly shown. The final step is to check that the keys are functioning correctly. This requires user interaction.

When **☒** blinks, seven icons are displayed. You are requested to press the seven function keys on the keypad one by one in any order. Each time you press a key, an icon disappears from the display; continue to press the other keys until all the icons have disappeared.

When self-diagnosis has been completed, **✓** appears. If self-diagnosis fails, "Err 1" appears (see Section 4.7).

Note

You have to finish pressing all the seven keys within two minutes, otherwise "Err 1" appears, and you will have to repeat the procedure.

4.7 Error messages

Err 1	Self-diagnosis failed	Repeat the self-diagnosis procedure and make sure that you finish pressing all seven keys within two minutes. If "Err 1" still appears, call METTLER TOLEDO Service.
Err 2	Measured value out of range	Make sure that the electrode wetting cap has been removed and that the electrode is properly connected and placed in the sample solution. If no electrode is connected, put the shorting plug in the socket.
Err 3	Measured buffer temperature out of range (5...50 °C)	Keep the buffer temperature within the range for calibration.
Err 4	Offset out of range	Make sure you have the correct buffer and that it is fresh. Clean or replace the electrode.
Err 5	Slope out of range	Make sure you have the correct buffer and that it is fresh. Clean or replace the electrode.
Err 6	Meter cannot recognize the buffer	Make sure you have the correct buffer and that it is fresh. Check that the buffer has not been used more than once during the calibration.
Err 7	Data entry error in setting the user-defined buffer	When entering the user-defined buffer value, the meter does not accept a value whose pH differs by less than 1 pH unit from other preset values. Reenter a value.
Err 8	ATC measured temperature is different to the user-defined value	Keep the buffer or sample at the set temperature or change the temperature setting.
Err 9	The current data set has already been stored once	A measurement can only be stored once. Perform a new measurement to store a new data set.

5. Maintenance

5.1 Meter maintenance

Never unscrew the two halves of the housing.

The SevenGo™ series instruments do not require any maintenance other than an occasional wipe with a damp cloth and the replacement of dead batteries.

The housing is made of acrylonitrile butadiene styrene/polycarbonate (ABS/PC). This material is attacked by some organic solvents, such as toluene, xylene and methyl ethyl ketone (MEK). Any spillage should be immediately wiped off.

5.2 Electrode maintenance

Make sure the electrode is always stored in an appropriate storage solution.

For maximum accuracy, any filling solution that may have "crept" and encrusted the outside of the electrode should be removed with deionized water.

Always store the electrode according to the manufacturer's instructions and do not allow it to dry out.

If the electrode slope falls rapidly, or if the response becomes sluggish, the following procedures may help. Try one of the following, depending on your sample.

1. For fat or oil build-up, degrease the membrane with cotton wool soaked in either acetone or a soap solution.
2. If the sensor membrane has dried out, soak the tip of the electrode in 0.1 M HCl overnight.
3. If protein build-up has occurred in the diaphragm, remove deposits by soaking the electrode in an HCl/pepsin solution (51340068).
4. If silver sulfide contamination has occurred, remove the deposits by soaking the electrode in a solution of thiourea (51340070).

After treatment a new calibration should be performed.

Note

Cleaning and filling solutions should be handled with the same care as that given to toxic or corrosive substances.

5.3 Disposal



In conformance with the European Directive 2002/96/ EC on Waste Electrical and Electronic Equipment (WEEE) this device may not be disposed of in domestic waste. This also applies to countries outside the EU, per their specific requirements.

Please dispose of this product in accordance with local regulations at the collecting point specified for electrical and electronic equipment.

If you have any questions, please contact the responsible authority or the distributor from which you purchased this device.

Should this device be passed on to other parties (for private or professional use), the content of this regulation must also be related.

Thank you for your contribution to environmental protection.

6. Accessories

	Order No.
SevenGo pro™ pH meter SG8	
SevenGo™ conductivity meter SG3	
SevenGo pro™ conductivity meter SG7	
SevenGo pro™ dissolved oxygen meter SG6	
InLab®413 SG (IP67) 3-in-1 pH electrode, PEEK shaft	51340288
InLab®413 SG/10m (IP67) 3-in-1 pH electrode, PEEK shaft	51340289
LE438 3-in-1 pH electrode, epoxy shaft	51340242/C
ErGo™ Field assistant (incl. adapter and ErGo™ electrode tube)	51302320
ErGo™ Electrode tube	51302323
Portable carry case (empty)	51302359
Field case accessory kit (Field electrode arm, protective cover, clip, 4 bottles)	51302360
Rubber holster	51302322
Plastic sample bottle	51300240
Wrist strap	51302331
Battery cover	51302328
Bottom cap blue	51302324
SevenGo™ clip	51302325
Clip cover	51302327
SevenGo™ sealing kit (sealing rings for battery case and electrode plugs)	51302336
Rubber feet (2 pcs.)	51302335
Field electrode arm	51302334
Shorting plug BNC	51302859
pH 4.01 buffer sachets, 30 x 20 mL	51302069
pH 4.01 buffer solution, colour red, 6 x 250 mL	51340058
pH 7.00 buffer sachets, 30 x 20 mL	51302047
pH 7.00 buffer solution, colour green, 6 x 250 mL	51340060
pH 9.21 buffer sachets, 30 x 20 mL	51302070
pH 9.21 buffer solution, colour blue, 6 x 250 mL	51300194
pH 10.01 buffer sachets, 30 x 20 mL	51302079
pH 10.01 buffer solution, colourless, 6 x 250 mL	51340231
Rainbow I (3 x 10 sachets 20 mL, 4.01/7.00/9.21)	51302068
Rainbow II (3 x 10 sachets 20 mL, 4.01/7.00/10.01)	51302080
HCl/pepsin solution (removes protein contamination)	51340068
Thiourea solution (removes silver sulfide contamination)	51340070
Reactivation solution for pH electrodes	51340073

7. Specifications

SevenGo™ pH meter SG2	
Measurement range	pH 0.00...14.00
	-1999...1999 mV
	-5 °C to 105 °C
Resolution	0.01 pH
	1 mV
	0.1 °C
Limits of error	± 0.01 pH
	± 1 mV
	± 0.5 °C
pH calibration	up to 3 points
Isopotential point	pH 7.00
Calibration buffer	4 predefined groups
	1 user-defined group of 3 buffers
Power requirements	Ratings: 6 V DC, 5 mA
	Batteries: 4 x AA/LR6 1.5 V
	or NiMH 1.2 V rechargeable
Size/Weight	220 x 90 x 45 mm / 0.33 kg
Display	Liquid crystal
pH input	BNC (IP67), impedance > 10 ¹² Ω
T input	Cinch (IP67), NTC 30 kΩ
IP rating	IP67 with and without electrode
Battery life	> 500 working hours
Ambient conditions	Temperature: 5...40 °C
	Relative humidity: 5%...80% (non-condensing)
	Installation category: II
	Pollution degree: 2
Materials	Housing: ABS/PC reinforced
	Window: polymethylmethacrylate (PMMA)
	Keypad: silicone rubber

8. Appendix

8.1 Buffer tables

SevenGo™ pH Meters automatically correct for the temperature dependence of the buffer pH using the values given in the tables:

Buffer Set 1 (ref. 25 °C) MT US

5	7.09	4.00	10.25	1.67
10	7.06	4.00	10.18	1.67
15	7.04	4.00	10.12	1.67
20	7.02	4.00	10.06	1.68
25	7.00	4.00	10.01	1.68
30	6.99	4.01	9.97	1.68
35	6.98	4.02	9.93	1.69
40	6.97	4.03	9.89	1.69
45	6.97	4.04	9.86	1.70
50	6.97	4.06	9.83	1.71

Buffer Set 2 (ref. 25 °C) MT Europe

5	7.09	4.01	9.45	2.02	11.72
10	7.06	4.00	9.38	2.01	11.54
15	7.04	4.00	9.32	2.00	11.36
20	7.02	4.00	9.26	2.00	11.18
25	7.00	4.01	9.21	2.00	11.00
30	6.99	4.01	9.16	1.99	10.82
35	6.98	4.02	9.11	1.99	10.64
40	6.97	4.03	9.06	1.98	10.46
45	6.97	4.04	9.03	1.98	10.28
50	6.97	4.06	8.99	1.98	10.10

Buffer Set 3 (ref. 20 °C) Merck

5	7.07	4.04	9.16	2.01	12.41
10	7.05	4.02	9.11	2.01	12.26
15	7.02	4.01	9.05	2.00	12.10
20	7.00	4.00	9.00	2.00	12.00
25	6.98	4.01	8.95	2.00	11.88
30	6.98	4.01	8.91	2.00	11.72
35	6.96	4.01	8.88	2.00	11.67
40	6.95	4.01	8.85	2.00	11.54
45	6.95	4.01	8.82	2.00	11.44
50	6.95	4.00	8.79	2.00	11.33

Buffer Set 4 (ref. 25 °C) JIS Z 8802

5	6.95	4.00	9.40	1.67
10	6.92	4.00	9.33	1.67
15	6.90	4.00	9.28	1.67
20	6.88	4.00	9.22	1.68
25	6.86	4.01	9.18	1.68
30	6.85	4.02	9.14	1.68
35	6.84	4.02	9.10	1.69
40	6.84	4.04	9.07	1.69
45	6.83	4.05	9.04	1.70
50	6.83	4.06	9.01	1.71

8.2 Error Limits

Message	Description	Range not accepted
Err 2	Value out of range	pH: < 0.00 or > 14.00 mV: < -1999 or > 1999
Err 3	Buffer temperature out of range	T [°C]: < 5 or > 50
Err 4	Offset out of range (first cal. point)	Eref1-Eb > 60 mV
Err 5	Slope out of range (following cal. points)	Eref1-Eb > 60 mV
Err 6	Wrong buffer	ΔEref1 < 10 mV
Err 7	Invalid pH for user-defined buffer	ΔpH < 1 pH
Err 8	ATC temperature different from set value	$t_{ATC} - t_{buffer}$ > 1 °C

维护您的梅特勒-托利多产品的未来，
梅特勒-托利多的服务确保了其所有产品今后的质量、测量准确性及保存价值。
请多提宝贵意见。
谢谢！

**To Protect your METTLER TOLEDO product's future:
METTLER TOLEDO Service assure the quality, measuring accuracy and preservation
of value of all METTLER TOLEDO products for years to come.
Please send for full details about our attractive terms of service.
Thank you.**

产品标准号：GB11165



如有技术变更，恕不另行通知。
Subject to technical changes and to the availability
of the accessories supplied with the instruments.

梅特勒-托利多仪器（上海）有限公司
上海市桂平路589号 邮编： 200233 电话： 021-64850435 传真： 021-64853351