



Diaphragm Pumps for Air, Gases and Vapours



LABOPOINT® Chemically-resistant Diaphragm Vacuum Pumps

Technical features:

- 100% oil-free transfer
- Pure transferring and evacuation of gases
- Highly compatible with vapours and condensation
- Chemically-resistant
- Therefore suitable for highly aggressive or corrosive gases and vapours
- Maintenance-free
- Environmentally friendly
- Gastight, leakage rate approx. 6×10^{-3} mbar x l/s, not tested in serial production.

Series LABOPOINT® N 810 FT.18, N 810.3 FT.18 Pumps

The chemically-resistant series N 810 and N 810.3 diaphragm pumps are single- and double-head, dry-running devices used in a wide range of laboratory applications. They transfer and pump down without contamination.

The heart of these very compact pumps is a KNF structured diaphragm. This patented diaphragm was stress-optimized using the Finite Elements method. As a result, we were able to make the pumps smaller while increasing the service life of the diaphragm.

Material in contact with the pumped media

Type/OrderNo.	Pump head	Diaphragm	Valves
N 810 FT.18	PTFE	PTFE-coated	FFPM
N 810.3 FT.18	PTFE	PTFE-coated	FFPM

Technical data:	N 810 FT.18	N 810.3 FT.18
Delivery (l/min) ¹⁾	10	10
Ultimate vacuum (mbar abs.)	100	8
Operating pressure (bar g)	1	1
Connectors for tube (mm)	ID 10	ID 10
Permissible gas and ambient temperature	+5...+40 °C	+5...+40 °C
Voltage/Frequencies	230V/50Hz	230V/50Hz
Mains	IP 44	IP 44
Power P ₁	100 W	90 W
Operating current	0.6 A	0.6 A
Weight	5.9 kg	6.9 kg
Dimensions		
LxHxW (mm)	256/187/146	281/187/140
With thermal switch and power fuse		

Motors with other voltages and frequencies on request.

¹⁾ at atm. pressure

Dimensions and performance characteristics

Pump down time for 10 l receiver

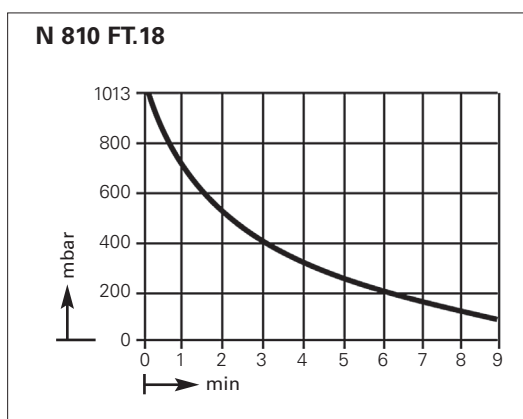

Performance characteristics

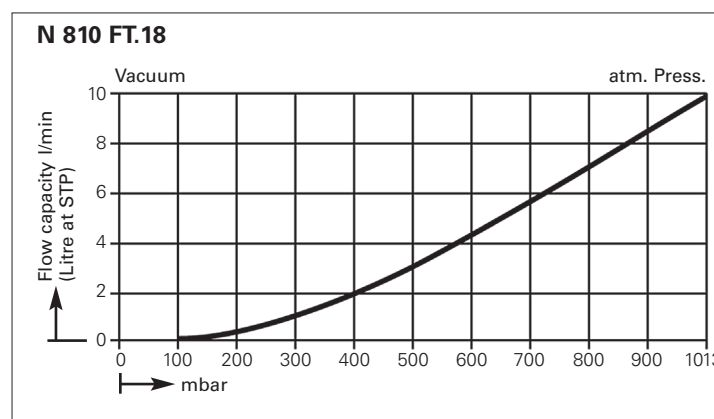



Pump down time for 10 l receiver

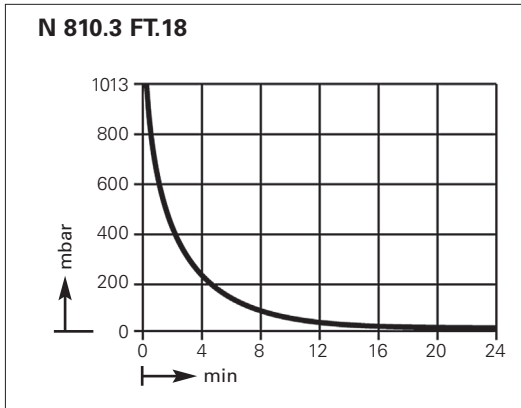

Performance characteristics

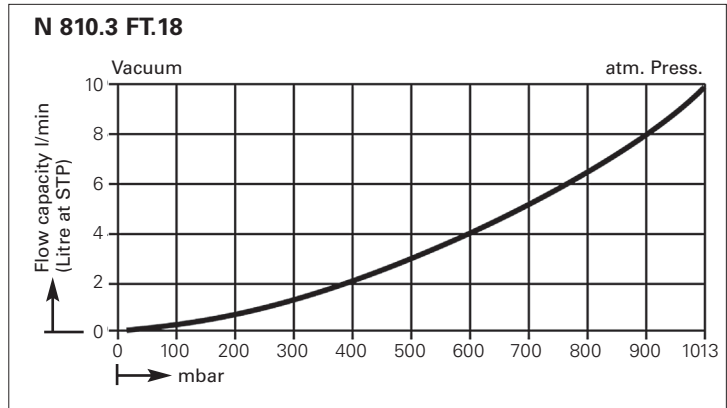

Dimensions (mm)

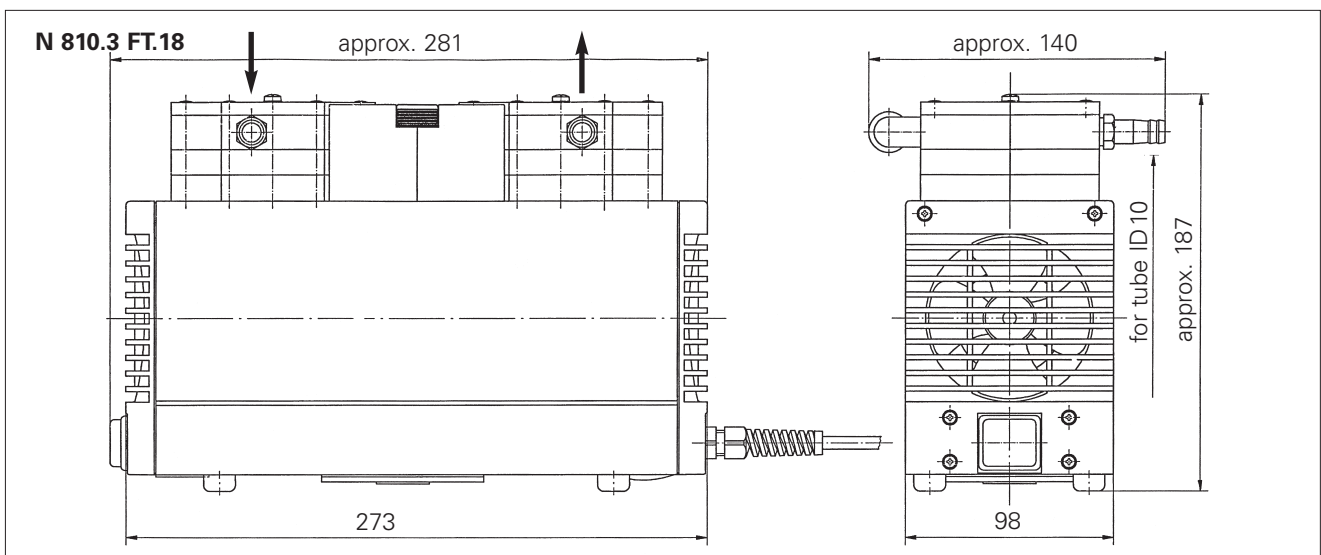
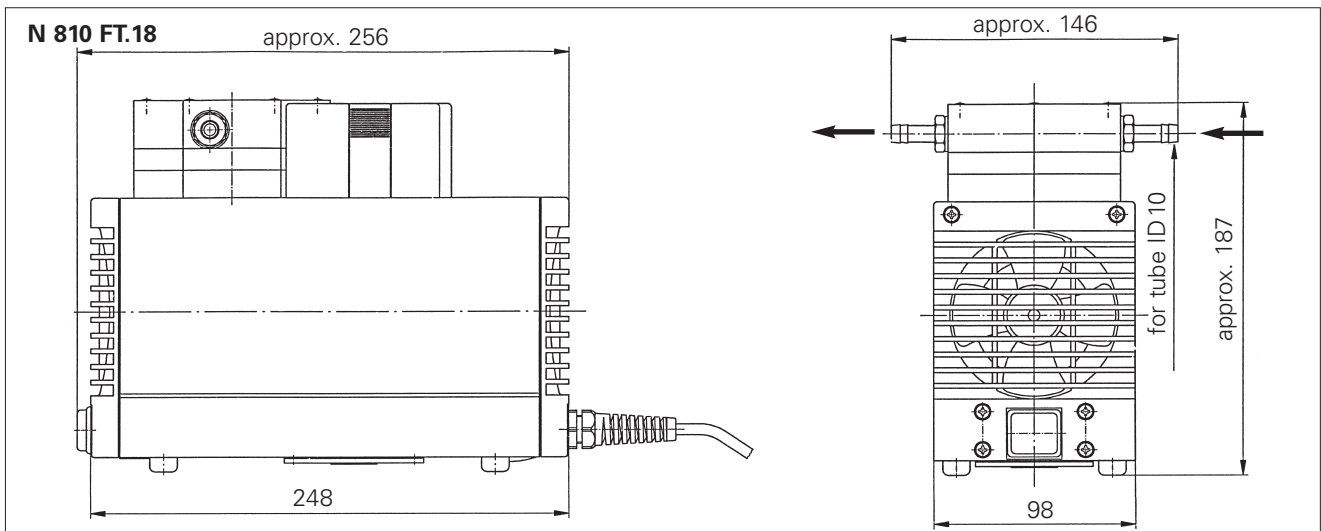

Spare parts

Description	Details	Order No.
Spares kit	for N 810 FT.18	058077
Spares kit	for N 810.3 FT.18	057357



The KNF-Group worldwide

Germany

KNF Neuberger GmbH
Alter Weg 3
D-79112 Freiburg
Tel. +49 7664 5909 0
Fax +49 7664 5909 99
info@knf.de
www.knf.de

Benelux Netherlands

KNF Verder B.V.
Utrechtseweg 4a
NL-3451 GG Vleuten
Tel. +31 30 677 92 40
Fax +31 30 677 92 47
info@knf-verder.nl
www.knf-verder.nl

Benelux Belgium and Luxembourg

KNF Verder N.V.
Kontichsesteenweg 17
B-2630 Aartselaar
Tel. +32 3 871 96 24
Fax +32 3 871 96 28
info@knf.be
www.knf.be

China

KNF Neuberger Trading
(Shanghai) Co., Ltd.
No. 36 Lane 1000
Zhang Heng Road
Shanghai 201203
Tel. +86 21 6859 6566
Fax +86 21 6859 6568
info@knf.com.cn
www.knf.com.cn

France,

Marocco, Tunisia, Algeria

KNF Neuberger S.A.
4, Bld. d'Alsace Z.I.
F-68128 Village-Neuf
Tel. +33 389 70 35 00
Fax +33 389 69 92 52
info@knf.fr
www.knf.fr

United Kingdom

KNF Neuberger U.K., Ltd.
Avenue 2, Station Lane
Industrial Estate
Witney, Oxfordshire OX28 4FA
Tel. +44 1993 77 83 73
Fax +44 1993 77 51 48
info@knf.co.uk
www.knf.co.uk

India

KNF Pumps + Systems (India) Pvt. Ltd.
RAJIV GANDHI INFOTECH PARK,
Phase 1,
Ganga Estate, Survey No. 152/2/2,
Above AXIS BANK,
Hinjewadi, Pune 411 057
Tel. +91 20 640 13 923
+91 20 640 08 923
Fax +91 20 229 33 923
info@knfpumps.in
www.knfpumps.in

Italy

KNF ITALIA S.r.l.
Via Flumendosa, 10
I-20132 Milano
Tel. +39 02 272 03 860
Fax +39 02 272 03 848
info@knf.it
www.knf.it

Japan

KNF Japan Co.Ltd.
Across Shinkawa Bldg. Annex 3F,
1-16-14 Shinkawa, Chuo-ku,
Tokyo 104-0033
Tel. +81 3 3551 7931
Fax +81 3 3551 7932
info@knf.co.jp
www.knf.co.jp

Korea

KNF Neuberger Ltd.
Woosan Bldg.Rm#202
336-4, Hwikyung-Dong
Dongdaemun-Ku
130-090, Seoul
Tel. +82 2 959 0255
Fax +82 2 959 0254
knf@knfkorea.com
www.knfkorea.com

Sweden, Finland, Denmark, Norway

KNF Neuberger AB
Mejerivägen 4
P.O. Box 44060
SE-10073 Stockholm
Tel. +46 8 744 51 13
Fax +46 8 744 51 17
info@knf.se
www.knf.se

Switzerland Sales

KNF Neuberger AG
Stockenstrasse 6
CH-8362 Balterswil
Tel. +41 71 973 99 30
Fax +41 71 973 99 31
knf@knf.ch
www.knf.ch

Switzerland

Production Liquid Pumps
KNF FLODOS AG
Wassermatte 2
CH-6210 Sursee
Tel. +41 41 925 00 25
Fax +41 41 925 00 37
info@knf-flodos.ch
www.knf-flodos.ch

Switzerland

Production Micro Pumps
KNF Micro AG
Zelglimatte 1b
CH-6260 Reiden
Tel. +41 62 787 88 88
Fax +41 62 787 88 99
info@knf-micro.ch
www.knf-micro.ch

Taiwan

KNF Neuberger Ltd.
9F-2, No. 24, Lane 123, Section 6,
Min Chuan East Road
Neihu District
Taipei City, 11490
Tel. +886 2 2794 1011
Fax +886 2 8792 1648
knftwn@knftwn.com.tw
www.knftwn.com.tw

USA, Canada, South America

KNF Neuberger, INC.
Two Black Forest Road
Trenton, New Jersey 08691-1810
Tel. +1 609 890 8600
Fax +1 609 890 8323
knfusa@knf.com
www.knfusa.com
Latin America
Tel. +1 609 649 1010
gb@knf.com

Diaphragm Pumps + Systems



KNF Neuberger GmbH



KNF Neuberger, INC.



KNF Micro AG



KNF Neuberger S.A.



KNF FLODOS AG

The KNF-Production worldwide

Germany

KNF Neuberger GmbH
Freiburg-Munzingen

France

KNF Neuberger S.A.
Village-Neuf

Switzerland

KNF FLODOS AG
Sursee

Switzerland

KNF Micro AG
Reiden

USA

KNF Neuberger, INC.
Trenton - New Jersey



Diaphragm Pumps for Air, Gases and Vapours



LABOPORT® Chemically-resistant Diaphragm Vacuum Pumps

Technical features:

- 100% oil-free transfer
- Pure transferring and evacuation of gases
- Highly compatible with vapours and condensation
- Chemically-resistant
- Therefore suitable for highly aggressive or corrosive gases and vapours
- Maintenance-free
- Environmentally friendly
- Gastight, leakage rate approx. 6×10^{-3} mbar x l/s, not tested in serial production.

Series LABOPORT® N 820 FT.18, N 820.3 FT.18 Pumps

The chemically-resistant series N 820 and N 820.3 diaphragm pumps are single- and double-head, dry-running devices used in a wide range of laboratory applications. They transfer and pump down without contamination.

The heart of these very compact pumps is a KNF structured diaphragm. This patented diaphragm was stress-optimized using the Finite Elements method. As a result, we were able to make the pumps smaller while increasing the service life of the diaphragm.

Material in contact with the pumped media

Type/OrderNo.	Pump head	Diaphragm	Valves
N 820 FT.18	PTFE	PTFE-coated	FFPM
N 820.3 FT.18	PTFE	PTFE-coated	FFPM

Technical data:	N 820 FT.18	N 820.3 FT.18
Delivery (l/min) ¹⁾	20	20
Ultimate vacuum (mbar abs.)	100	8
Operating pressure (bar g)	1	1
Connectors for tube (mm)	ID 10	ID 10
Permissible gas and ambient temperature	+5...+40 °C	+5...+40 °C
Mains	230V/50Hz	230V/50Hz
Motor protection	IP 44	IP 44
Power P ₁	130 W	120 W
Operating current	0.9 A	0.7 A
Weight	7.1 kg	9.3 kg
Dimensions LxHxW (mm)	268/207/159	312/207/154
With thermal switch and power fuse		

Motors with other voltages and frequencies on request.

¹⁾ at atm. pressure

Dimensions and performance characteristics

Pump down time for 10 l receiver

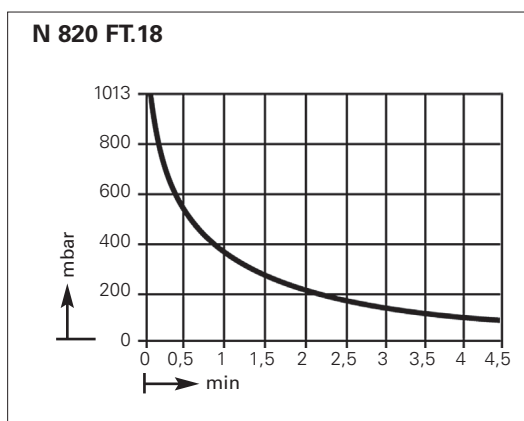

Performance characteristics

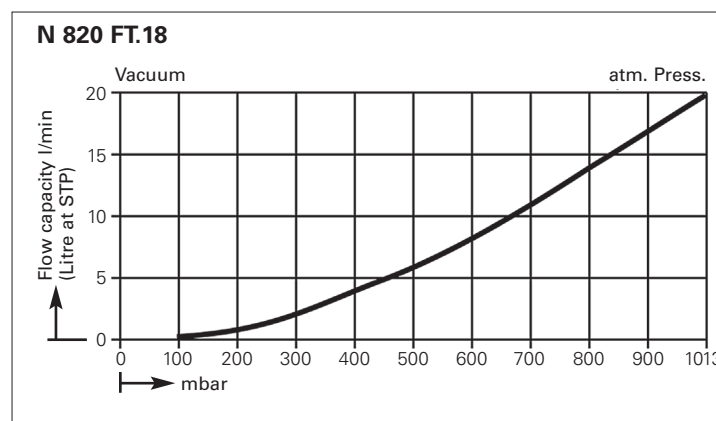



Pump down time for 10 l receiver

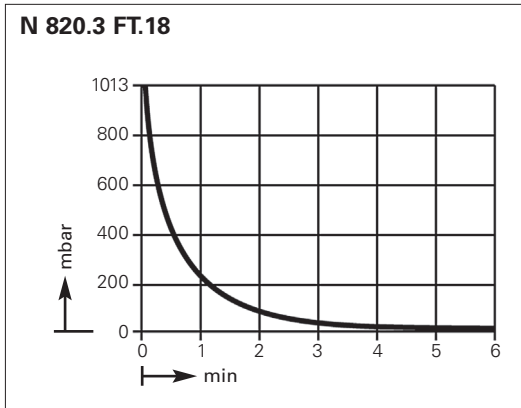

Performance characteristics

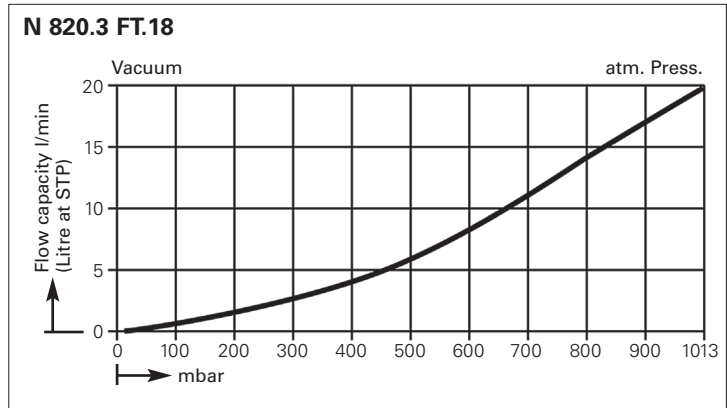

Dimensions (mm)

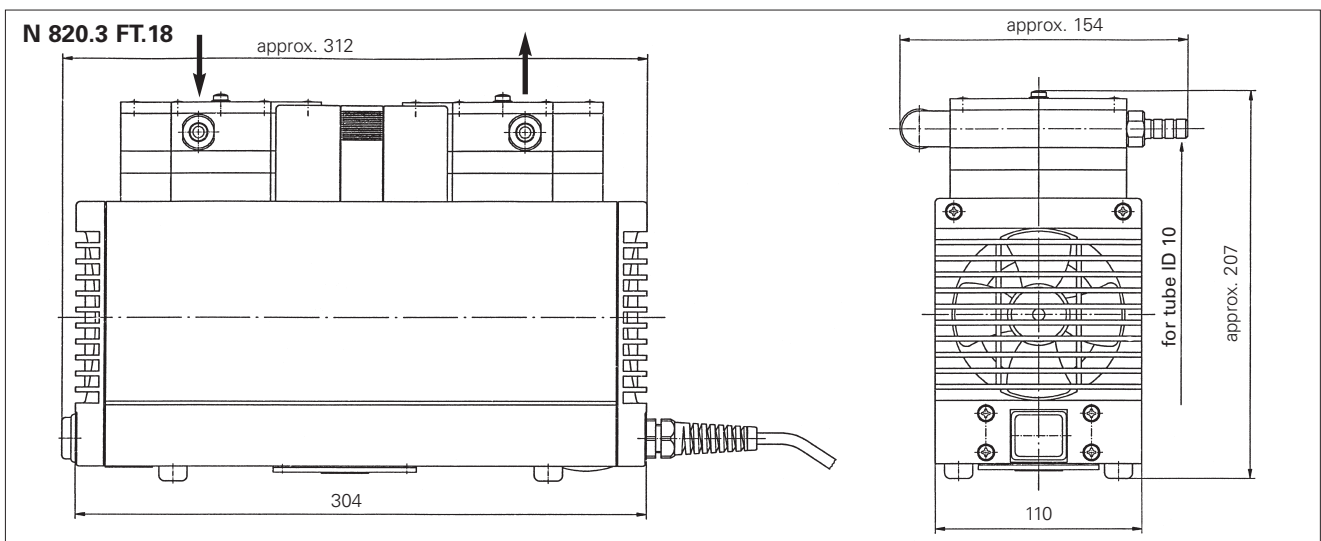
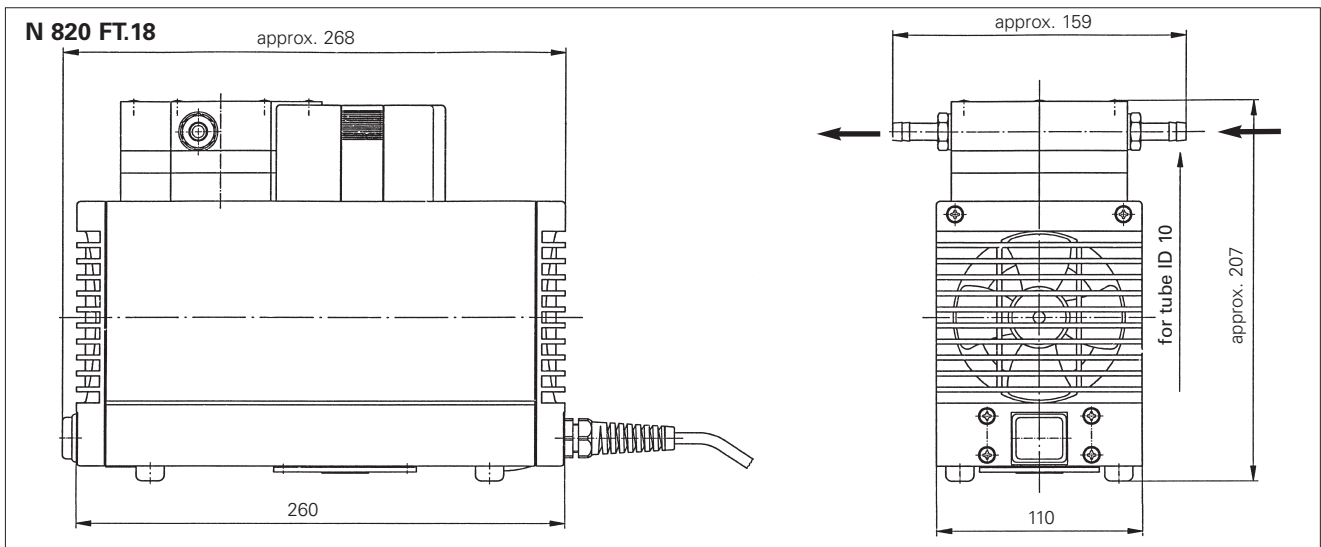

Spare parts

Description	Details	Order No.
Spares kit	for N 820 FT.18	058078
Spares kit	for N 820.3 FT.18	057358



The KNF-Group worldwide

Germany

KNF Neuberger GmbH
Alter Weg 3
D-79112 Freiburg
Tel. +49 7664 5909 0
Fax +49 7664 5909 99
info@knf.de
www.knf.de

Benelux Netherlands

KNF Verder B.V.
Utrechtseweg 4a
NL-3451 GG Vleuten
Tel. +31 30 677 92 40
Fax +31 30 677 92 47
info@knf-verder.nl
www.knf-verder.nl

Benelux Belgium and Luxembourg

KNF Verder N.V.
Kontichsesteenweg 17
B-2630 Aartselaar
Tel. +32 3 871 96 24
Fax +32 3 871 96 28
info@knf.be
www.knf.be

China

KNF Neuberger Trading
(Shanghai) Co., Ltd.
No. 36 Lane 1000
Zhang Heng Road
Shanghai 201203
Tel. +86 21 6859 6566
Fax +86 21 6859 6568
info@knf.com.cn
www.knf.com.cn

France,

Marocco, Tunisia, Algeria

KNF Neuberger S.A.
4, Bld. d'Alsace Z.I.
F-68128 Village-Neuf
Tel. +33 389 70 35 00
Fax +33 389 69 92 52
info@knf.fr
www.knf.fr

United Kingdom

KNF Neuberger U.K., Ltd.
Avenue 2, Station Lane
Industrial Estate
Witney, Oxfordshire OX28 4FA
Tel. +44 1993 77 83 73
Fax +44 1993 77 51 48
info@knf.co.uk
www.knf.co.uk

India

KNF Pumps + Systems (India) Pvt. Ltd.
RAJIV GANDHI INFOTECH PARK,
Phase 1,
Ganga Estate, Survey No. 152/2/2,
Above AXIS BANK,
Hinjewadi, Pune 411 057
Tel. +91 20 640 13 923
+91 20 640 08 923
Fax +91 20 229 33 923
info@knfpumps.in
www.knfpumps.in

Italy

KNF ITALIA S.r.l.
Via Flumendosa, 10
I-20132 Milano
Tel. +39 02 272 03 860
Fax +39 02 272 03 848
info@knf.it
www.knf.it

Japan

KNF Japan Co.Ltd.
Across Shinkawa Bldg. Annex 3F,
1-16-14 Shinkawa, Chuo-ku,
Tokyo 104-0033
Tel. +81 3 3551 7931
Fax +81 3 3551 7932
info@knf.co.jp
www.knf.co.jp

Korea

KNF Neuberger Ltd.
Woosan Bldg.Rm#202
336-4, Hwikyung-Dong
Dongdaemun-Ku
130-090, Seoul
Tel. +82 2 959 0255
Fax +82 2 959 0254
knf@knfkorea.com
www.knfkorea.com

Sweden, Finland, Denmark, Norway

KNF Neuberger AB
Mejerivägen 4
P.O. Box 44060
SE-10073 Stockholm
Tel. +46 8 744 51 13
Fax +46 8 744 51 17
info@knf.se
www.knf.se

Switzerland Sales

KNF Neuberger AG
Stockenstrasse 6
CH-8362 Balterswil
Tel. +41 71 973 99 30
Fax +41 71 973 99 31
knf@knf.ch
www.knf.ch

Switzerland

Production Liquid Pumps
KNF FLODOS AG
Wassermatte 2
CH-6210 Sursee
Tel. +41 41 925 00 25
Fax +41 41 925 00 37
info@knf-flodos.ch
www.knf-flodos.ch

Switzerland

Production Micro Pumps
KNF Micro AG
Zelglimatte 1b
CH-6260 Reiden
Tel. +41 62 787 88 88
Fax +41 62 787 88 99
info@knf-micro.ch
www.knf-micro.ch

Taiwan

KNF Neuberger Ltd.
9F-2, No. 24, Lane 123, Section 6,
Min Chuan East Road
Neihu District
Taipei City, 11490
Tel. +886 2 2794 1011
Fax +886 2 8792 1648
knftwn@knftwn.com.tw
www.knftwn.com.tw

USA, Canada, South America

KNF Neuberger, INC.
Two Black Forest Road
Trenton, New Jersey 08691-1810
Tel. +1 609 890 8600
Fax +1 609 890 8323
knfusa@knf.com
www.knfusa.com
Latin America
Tel. +1 609 649 1010
gb@knf.com

Diaphragm Pumps + Systems



KNF Neuberger GmbH



KNF Neuberger, INC.



KNF Micro AG



KNF Neuberger S.A.



KNF FLODOS AG

The KNF-Production worldwide

Germany

KNF Neuberger GmbH
Freiburg-Munzingen

France

KNF Neuberger S.A.
Village-Neuf

Switzerland

KNF FLODOS AG
Sursee

Switzerland

KNF Micro AG
Reiden

USA

KNF Neuberger, INC.
Trenton - New Jersey



Diaphragm Pumps for Air, Gases and Vapours

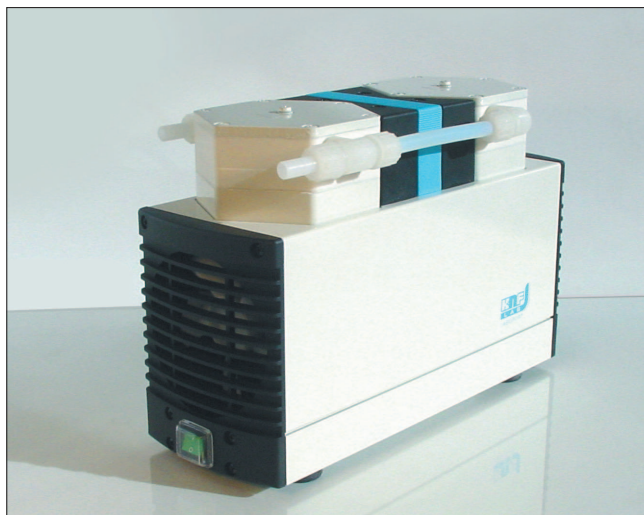

LABOPORT® Chemically-resistant Diaphragm Vacuum Pump

Technical features:

- 100% oil-free transfer
- Pure transferring and evacuation of gases
- Highly compatible with vapours and condensation
- Chemically-resistant
- Therefore suitable for highly aggressive or corrosive gases and vapours
- Maintenance-free
- Environmentally friendly
- Gastight, leakage rate approx. 6×10^{-3} mbar x l/s, not tested in serial production.

Serie LABOPORT® N 840.1.2 FT.18 Pump

The chemically-resistant serie N 840.1.2 diaphragm pump is a double-head, dry-running device used in a wide range of laboratory applications. These pump transfer and pump down without contamination.

The heart of this very compact pump is a KNF structured diaphragm. This patented diaphragm was stress-optimized using the Finite Elements method. As a result, we were able to make the pump smaller while increasing the service life of the diaphragm.

Technical data: **N 840.1.2 FT.18**

Delivery (l/min) ¹⁾	60
Ultimate vacuum (mbar abs.)	90
operating pressure (bar g)	1
Connectors for tube (mm)	ID 10
Permissible gas and ambient temperature	+5...+40 °C
Mains	230V/50Hz
Motor protection	IP 44
Power P ₁	270 W
Operating current	1.9 A
Weight	12.6 kg
Dimensions	
LxHxW (mm)	341/226/160
With thermal switch and power fuse	

Motors with other voltages and frequencies on request.

Material in contact with the pumped media

Type/OrderNo.	Pump head	Diaphragm	Valves
N 840.1.2 FT.18	PTFE	PTFE-coated	FFPM

¹⁾ at atm. pressure

Spare parts

Description	Order No.
Spares kit	057359



Diaphragm Pumps for Air, Gases and Vapours

Dimensions and performance characteristics

Pump down time for 10 l receiver

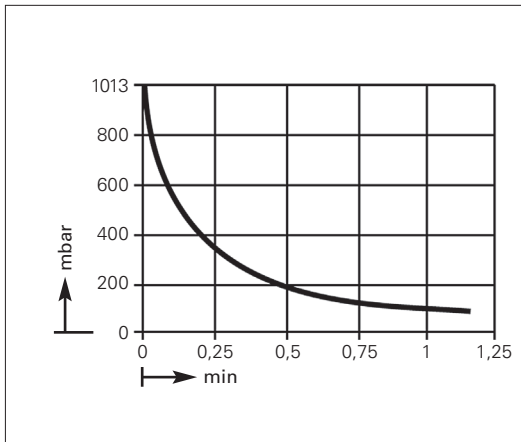

Performance characteristics

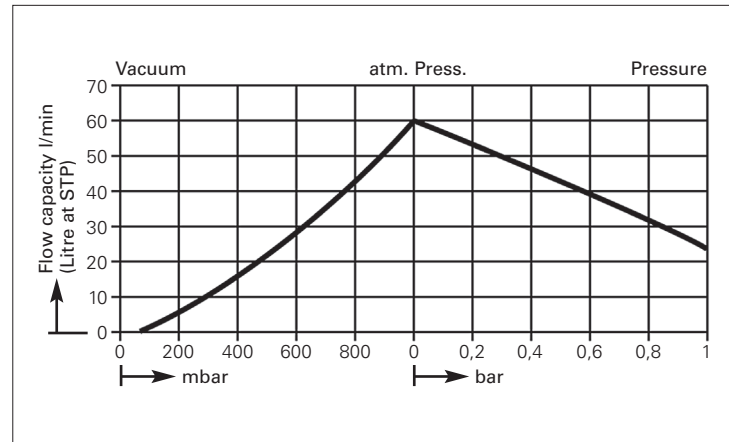

Dimensions (mm)

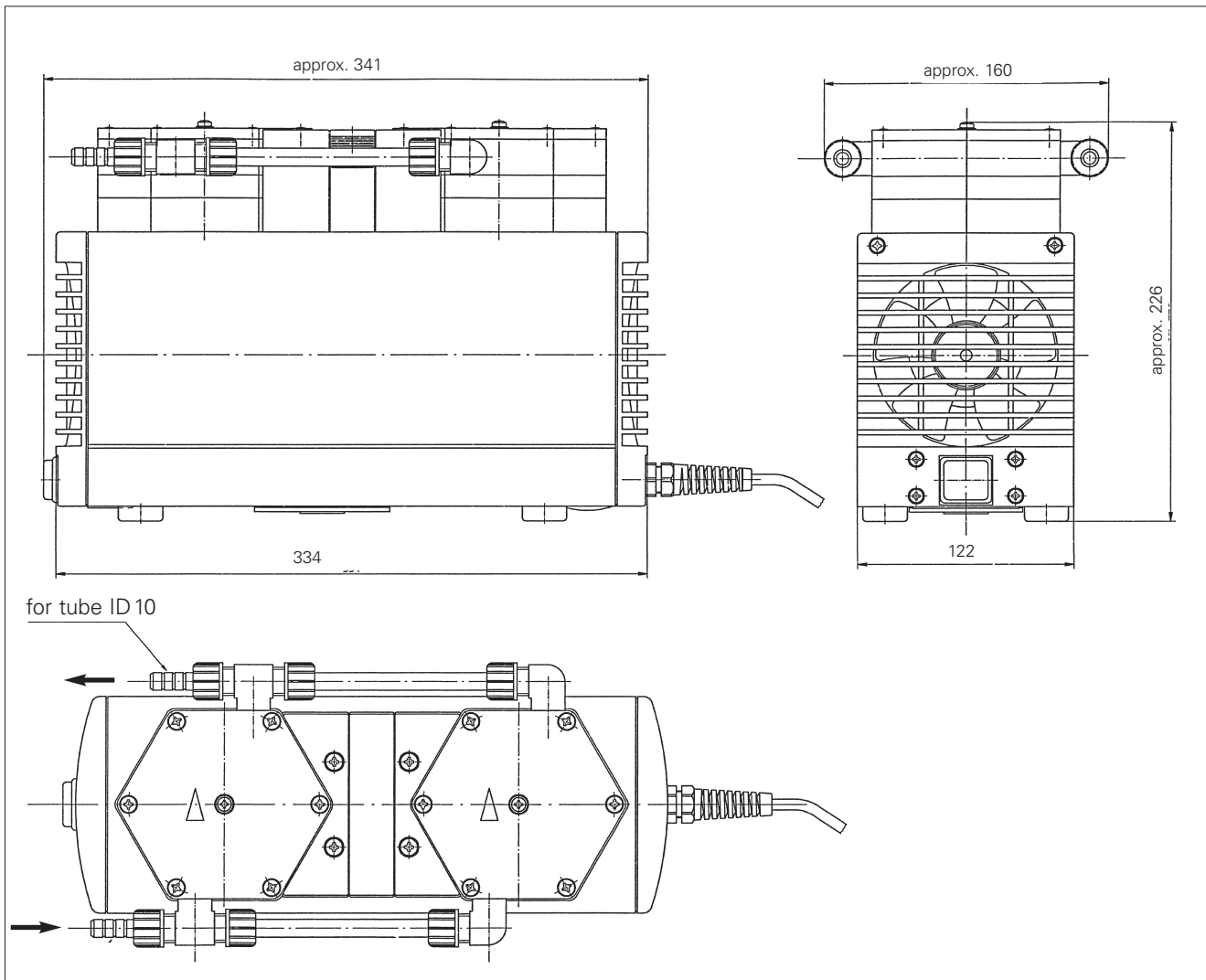



The KNF-Group worldwide

Germany

KNF Neuberger GmbH
Alter Weg 3
D-79112 Freiburg
Tel. +49 7664 5909 0
Fax +49 7664 5909 99
info@knf.de
www.knf.de

Benelux Netherlands

KNF Verder B.V.
Utrechtseweg 4a
NL-3451 GG Vleuten
Tel. +31 30 677 92 40
Fax +31 30 677 92 47
info@knf-verder.nl
www.knf-verder.nl

Benelux Belgium and Luxembourg

KNF Verder N.V.
Kontichsesteenweg 17
B-2630 Aartselaar
Tel. +32 3 871 96 24
Fax +32 3 871 96 28
info@knf.be
www.knf.be

China

KNF Neuberger Trading
(Shanghai) Co., Ltd.
No. 36 Lane 1000
Zhang Heng Road
Shanghai 201203
Tel. +86 21 6859 6566
Fax +86 21 6859 6568
info@knf.com.cn
www.knf.com.cn

France,

Marocco, Tunisia, Algeria

KNF Neuberger S.A.
4, Bld. d'Alsace Z.I.
F-68128 Village-Neuf
Tel. +33 389 70 35 00
Fax +33 389 69 92 52
info@knf.fr
www.knf.fr

United Kingdom

KNF Neuberger U.K., Ltd.
Avenue 2, Station Lane
Industrial Estate
Witney, Oxfordshire OX28 4FA
Tel. +44 1993 77 83 73
Fax +44 1993 77 51 48
info@knf.co.uk
www.knf.co.uk

India

KNF Pumps + Systems (India) Pvt. Ltd.
RAJIV GANDHI INFOTECH PARK,
Phase 1,
Ganga Estate, Survey No. 152/2/2,
Above AXIS BANK,
Hinjewadi, Pune 411 057
Tel. +91 20 640 13 923
+91 20 640 08 923
Fax +91 20 229 33 923
info@knfpumps.in
www.knfpumps.in

Italy

KNF ITALIA S.r.l.
Via Flumendosa, 10
I-20132 Milano
Tel. +39 02 272 03 860
Fax +39 02 272 03 848
info@knf.it
www.knf.it

Japan

KNF Japan Co.Ltd.
Across Shinkawa Bldg. Annex 3F,
1-16-14 Shinkawa, Chuo-ku,
Tokyo 104-0033
Tel. +81 3 3551 7931
Fax +81 3 3551 7932
info@knf.co.jp
www.knf.co.jp

Korea

KNF Neuberger Ltd.
Woosan Bldg.Rm#202
336-4, Hwikyung-Dong
Dongdaemun-Ku
130-090, Seoul
Tel. +82 2 959 0255
Fax +82 2 959 0254
knf@knfkorea.com
www.knfkorea.com

Sweden, Finland, Denmark, Norway

KNF Neuberger AB
Mejerivägen 4
P.O. Box 44060
SE-10073 Stockholm
Tel. +46 8 744 51 13
Fax +46 8 744 51 17
info@knf.se
www.knf.se

Switzerland Sales

KNF Neuberger AG
Stockenstrasse 6
CH-8362 Balterswil
Tel. +41 71 973 99 30
Fax +41 71 973 99 31
knf@knf.ch
www.knf.ch

Switzerland

Production Liquid Pumps
KNF FLODOS AG
Wassermatte 2
CH-6210 Sursee
Tel. +41 41 925 00 25
Fax +41 41 925 00 37
info@knf-flodos.ch
www.knf-flodos.ch

Switzerland

Production Micro Pumps
KNF Micro AG
Zelglimatte 1b
CH-6260 Reiden
Tel. +41 62 787 88 88
Fax +41 62 787 88 99
info@knf-micro.ch
www.knf-micro.ch

Taiwan

KNF Neuberger Ltd.
9F-2, No. 24, Lane 123, Section 6,
Min Chuan East Road
Neihu District
Taipei City, 11490
Tel. +886 2 2794 1011
Fax +886 2 8792 1648
knftwn@knftwn.com.tw
www.knftwn.com.tw

USA, Canada, South America

KNF Neuberger, INC.
Two Black Forest Road
Trenton, New Jersey 08691-1810
Tel. +1 609 890 8600
Fax +1 609 890 8323
knfusa@knf.com
www.knfusa.com
Latin America
Tel. +1 609 649 1010
gb@knf.com

Diaphragm Pumps + Systems



KNF Neuberger GmbH



KNF Neuberger, INC.



KNF Micro AG



KNF Neuberger S.A.



KNF FLODOS AG

The KNF-Production worldwide

Germany

KNF Neuberger GmbH
Freiburg-Munzingen

France

KNF Neuberger S.A.
Village-Neuf

Switzerland

KNF FLODOS AG
Sursee

Switzerland

KNF Micro AG
Reiden

USA

KNF Neuberger, INC.
Trenton - New Jersey



Diaphragm Pumps for Air, Gases and Vapours



LABOPORT® Chemically-resistant Diaphragm Vacuum Pumps

Technical features:

- 100% oil-free transfer
- Pure transferring and evacuation of gases
- Highly compatible with vapours and condensation
- Chemically-resistant
- Therefore suitable for highly aggressive or corrosive gases and vapours
- Maintenance-free
- Environmentally friendly
- Gastight, leakage rate approx. 6×10^{-3} mbar x l/s, not tested in serial production.

Series LABOPORT® N 840 FT.18, N 840.3 FT.18 Pumps

The chemically-resistant series N 840 and N 840.3 diaphragm pumps are single- and double-head, dry-running devices used in a wide range of laboratory applications. They transfer and pump down without contamination.

The heart of these very compact pumps is a KNF structured diaphragm. This patented diaphragm was stress-optimized using the Finite Elements method. As a result, we were able to make the pumps smaller while increasing the service life of the diaphragm.

Material in contact with the pumped media

Type/OrderNo.	Pump head	Diaphragm	Valves
N 840 FT.18	PTFE	PTFE-coated	FFPM
N 840.3 FT.18	PTFE	PTFE-coated	FFPM

Technical data:	N 840 FT.18	N 840.3 FT.18
Delivery (l/min) ¹⁾	34	34
Ultimate vacuum (mbar abs.)	100	8
Operating pressure (bar g)	1	1
Connectors for tube (mm)	ID 10	ID 10
Permissible gas and ambient temperature	+5...+40 °C	+5...+40 °C
Mains	230V/50Hz	230V/50Hz
Motor protection	IP 44	IP 44
Power P ₁	180 W	245 W
Operating current	1.5 A	1.5 A
Weight	10.3 kg	12.6 kg
Dimensions LxHxW (mm)	297/226/171	341/226/166

With thermal switch and power fuse

Motors with other voltages and frequencies on request.

¹⁾ at atm. pressure

Dimensions and performance characteristics

Pump down time for 10 l receiver

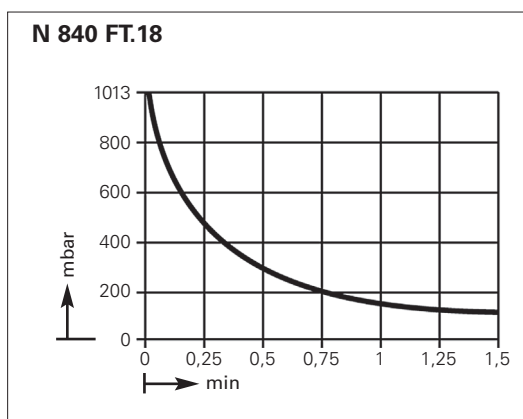

Performance characteristics

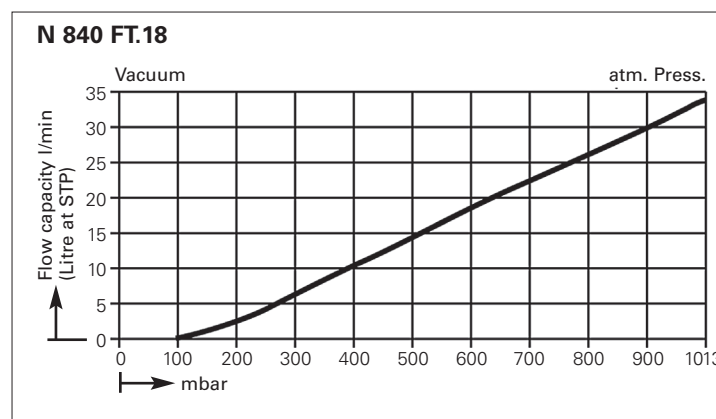



Pump down time for 10 l receiver

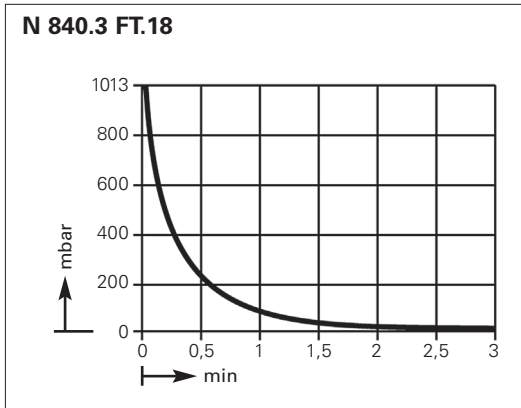

Performance characteristics

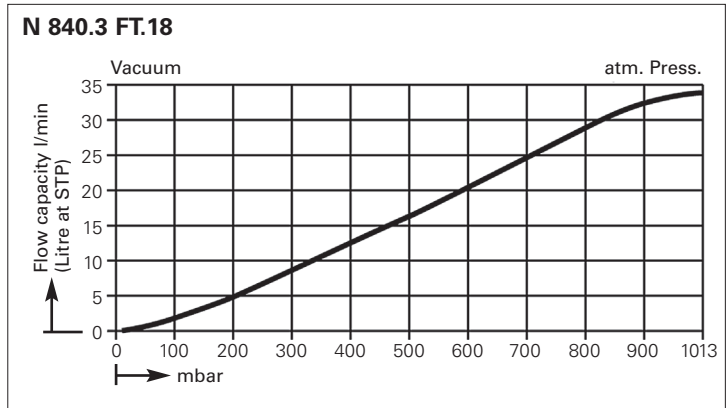

Dimensions (mm)

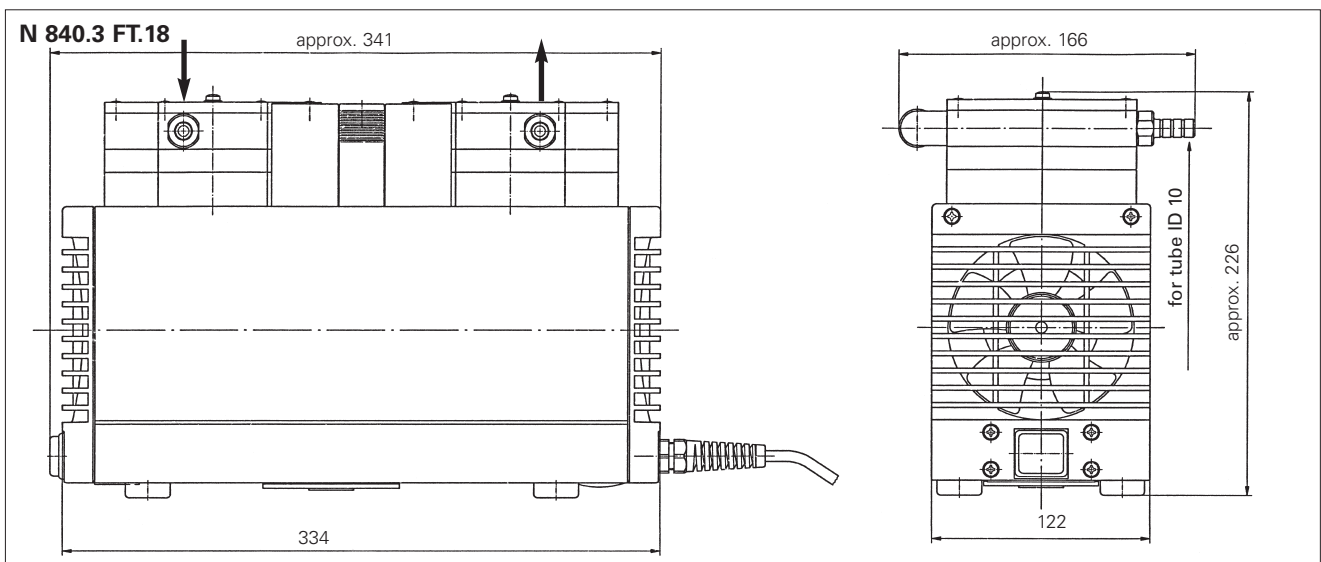
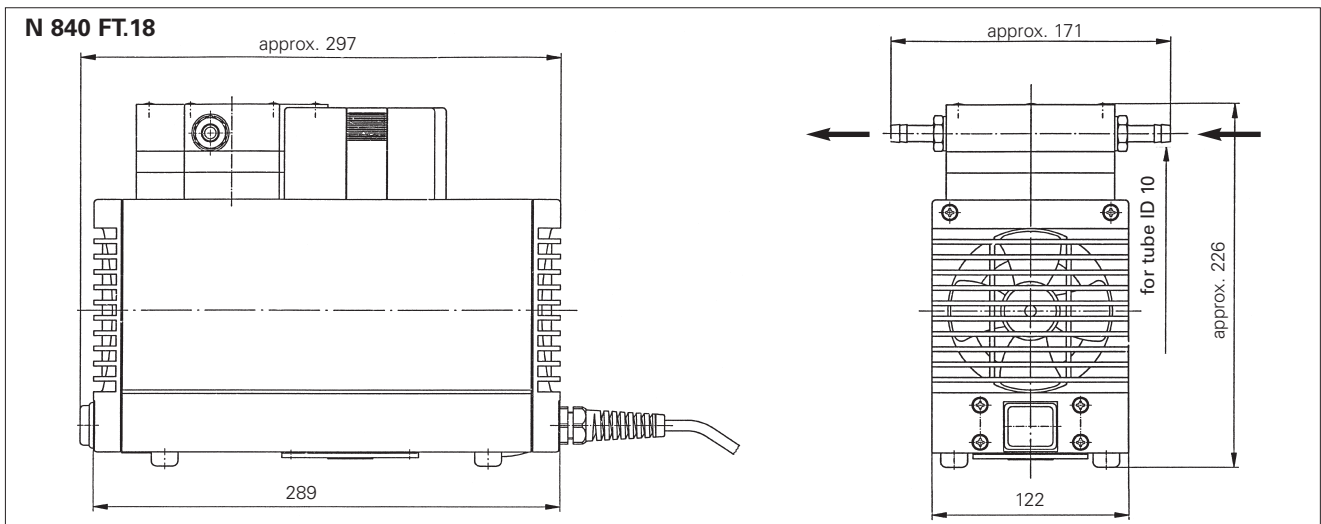

Spare parts

Description	Details	Order No.
Spares kit	for N 840 FT.18	058079
Spares kit	for N 840.3 FT.18	057359



The KNF-Group worldwide

Germany

KNF Neuberger GmbH
Alter Weg 3
D-79112 Freiburg
Tel. +49 7664 5909 0
Fax +49 7664 5909 99
info@knf.de
www.knf.de

Benelux Netherlands

KNF Verder B.V.
Utrechtseweg 4a
NL-3451 GG Vleuten
Tel. +31 30 677 92 40
Fax +31 30 677 92 47
info@knf-verder.nl
www.knf-verder.nl

Benelux Belgium and Luxembourg

KNF Verder N.V.
Kontichsesteenweg 17
B-2630 Aartselaar
Tel. +32 3 871 96 24
Fax +32 3 871 96 28
info@knf.be
www.knf.be

China

KNF Neuberger Trading
(Shanghai) Co., Ltd.
No. 36 Lane 1000
Zhang Heng Road
Shanghai 201203
Tel. +86 21 6859 6566
Fax +86 21 6859 6568
info@knf.com.cn
www.knf.com.cn

France,

Marocco, Tunisia, Algeria

KNF Neuberger S.A.
4, Bld. d'Alsace Z.I.
F-68128 Village-Neuf
Tel. +33 389 70 35 00
Fax +33 389 69 92 52
info@knf.fr
www.knf.fr

United Kingdom

KNF Neuberger U.K., Ltd.
Avenue 2, Station Lane
Industrial Estate
Witney, Oxfordshire OX28 4FA
Tel. +44 1993 77 83 73
Fax +44 1993 77 51 48
info@knf.co.uk
www.knf.co.uk

India

KNF Pumps + Systems (India) Pvt. Ltd.
RAJIV GANDHI INFOTECH PARK,
Phase 1,
Ganga Estate, Survey No. 152/2/2,
Above AXIS BANK,
Hinjewadi, Pune 411 057
Tel. +91 20 640 13 923
+91 20 640 08 923
Fax +91 20 229 33 923
info@knfpumps.in
www.knfpumps.in

Italy

KNF ITALIA S.r.l.
Via Flumendosa, 10
I-20132 Milano
Tel. +39 02 272 03 860
Fax +39 02 272 03 848
info@knf.it
www.knf.it

Japan

KNF Japan Co.Ltd.
Across Shinkawa Bldg. Annex 3F,
1-16-14 Shinkawa, Chuo-ku,
Tokyo 104-0033
Tel. +81 3 3551 7931
Fax +81 3 3551 7932
info@knf.co.jp
www.knf.co.jp

Korea

KNF Neuberger Ltd.
Woosan Bldg.Rm#202
336-4, Hwikyung-Dong
Dongdaemun-Ku
130-090, Seoul
Tel. +82 2 959 0255
Fax +82 2 959 0254
knf@knfkorea.com
www.knfkorea.com

Sweden, Finland, Denmark, Norway

KNF Neuberger AB
Mejerivägen 4
P.O. Box 44060
SE-10073 Stockholm
Tel. +46 8 744 51 13
Fax +46 8 744 51 17
info@knf.se
www.knf.se

Switzerland Sales

KNF Neuberger AG
Stockenstrasse 6
CH-8362 Balterswil
Tel. +41 71 973 99 30
Fax +41 71 973 99 31
knf@knf.ch
www.knf.ch

Switzerland

Production Liquid Pumps
KNF FLODOS AG
Wassermatte 2
CH-6210 Sursee
Tel. +41 41 925 00 25
Fax +41 41 925 00 37
info@knf-flodos.ch
www.knf-flodos.ch

Switzerland

Production Micro Pumps
KNF Micro AG
Zelglimatte 1b
CH-6260 Reiden
Tel. +41 62 787 88 88
Fax +41 62 787 88 99
info@knf-micro.ch
www.knf-micro.ch

Taiwan

KNF Neuberger Ltd.
9F-2, No. 24, Lane 123, Section 6,
Min Chuan East Road
Neihu District
Taipei City, 11490
Tel. +886 2 2794 1011
Fax +886 2 8792 1648
knftwn@knftwn.com.tw
www.knftwn.com.tw

USA, Canada, South America

KNF Neuberger, INC.
Two Black Forest Road
Trenton, New Jersey 08691-1810
Tel. +1 609 890 8600
Fax +1 609 890 8323
knfusa@knf.com
www.knfusa.com
Latin America
Tel. +1 609 649 1010
gb@knf.com

Diaphragm Pumps + Systems



KNF Neuberger GmbH



KNF Neuberger, INC.



KNF Micro AG



KNF Neuberger S.A.



KNF FLODOS AG

The KNF-Production worldwide

Germany

KNF Neuberger GmbH
Freiburg-Munzingen

France

KNF Neuberger S.A.
Village-Neuf

Switzerland

KNF FLODOS AG
Sursee

Switzerland

KNF Micro AG
Reiden

USA

KNF Neuberger, INC.
Trenton - New Jersey



Diaphragm Pumps for Air, Gases and Vapours



LABOPORT® Chemically-resistant Diaphragm Vacuum Pump

Technical features:

- 100% oil-free transfer
- Pure transferring and evacuation of gases
- Highly compatible with vapours and condensation
- Chemically-resistant
- Therefore suitable for highly aggressive or corrosive gases and vapours
- Maintenance-free
- Environmentally friendly
- Gastight, leakage rate approx. 6×10^{-3} mbar x l/s, not tested in serial production.

Serie LABOPORT® N 842.3 FT.18 Pump

The chemically-resistant serie N 842.3 diaphragm pump is a double-head, dry-running device used in a wide range of laboratory applications. These pump transfer and pump down without contamination.

The heart of this very compact pump is a KNF structured diaphragm. This patented diaphragm was stress-optimized using the Finite Elements method. As a result, we were able to make the pump smaller while increasing the service life of the diaphragm.

Technical data: **N 842.3 FT.18**

Delivery (l/min) ¹⁾	34
Ultimate vacuum (mbar abs.)	2
operating pressure (bar g)	1
Connectors for tube (mm)	ID 10
Permissible gas and ambient temperature	+5...+40 °C
Mains	230V/50Hz
Motor protection	IP 44
Power P ₁	245 W
Operating current	1.5 A
Weight	13.4 kg
Dimensions	
LxHxW (mm)	341/223/167
With thermal switch and power fuse	

Motors with other voltages and frequencies on request.

¹⁾ at atm. pressure

Material in contact with the pumped media

Type/OrderNo.	Pump head	Diaphragm	Valves
N 842.3 FT.18	PTFE	PTFE-coated	FFPM

Spare parts

Description	Order No.
Spares kit	057359



Diaphragm Pumps for Air, Gases and Vapours

Dimensions and performance characteristics

Pump down time for 10 l receiver

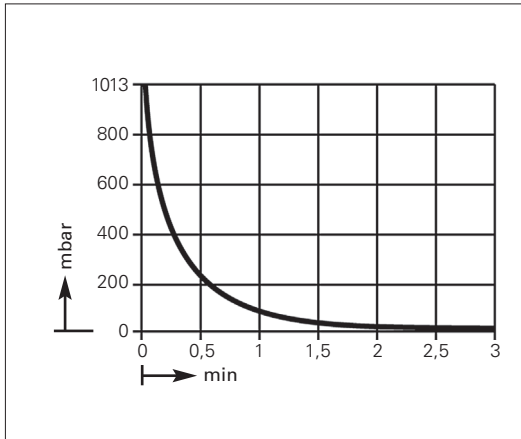

Performance characteristics

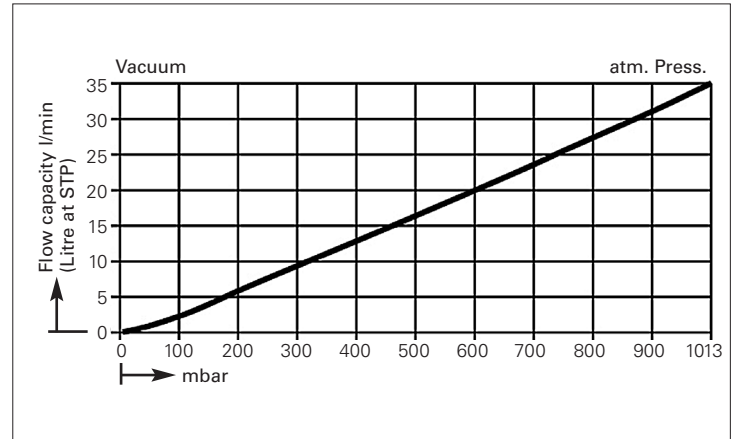

Dimensions (mm)

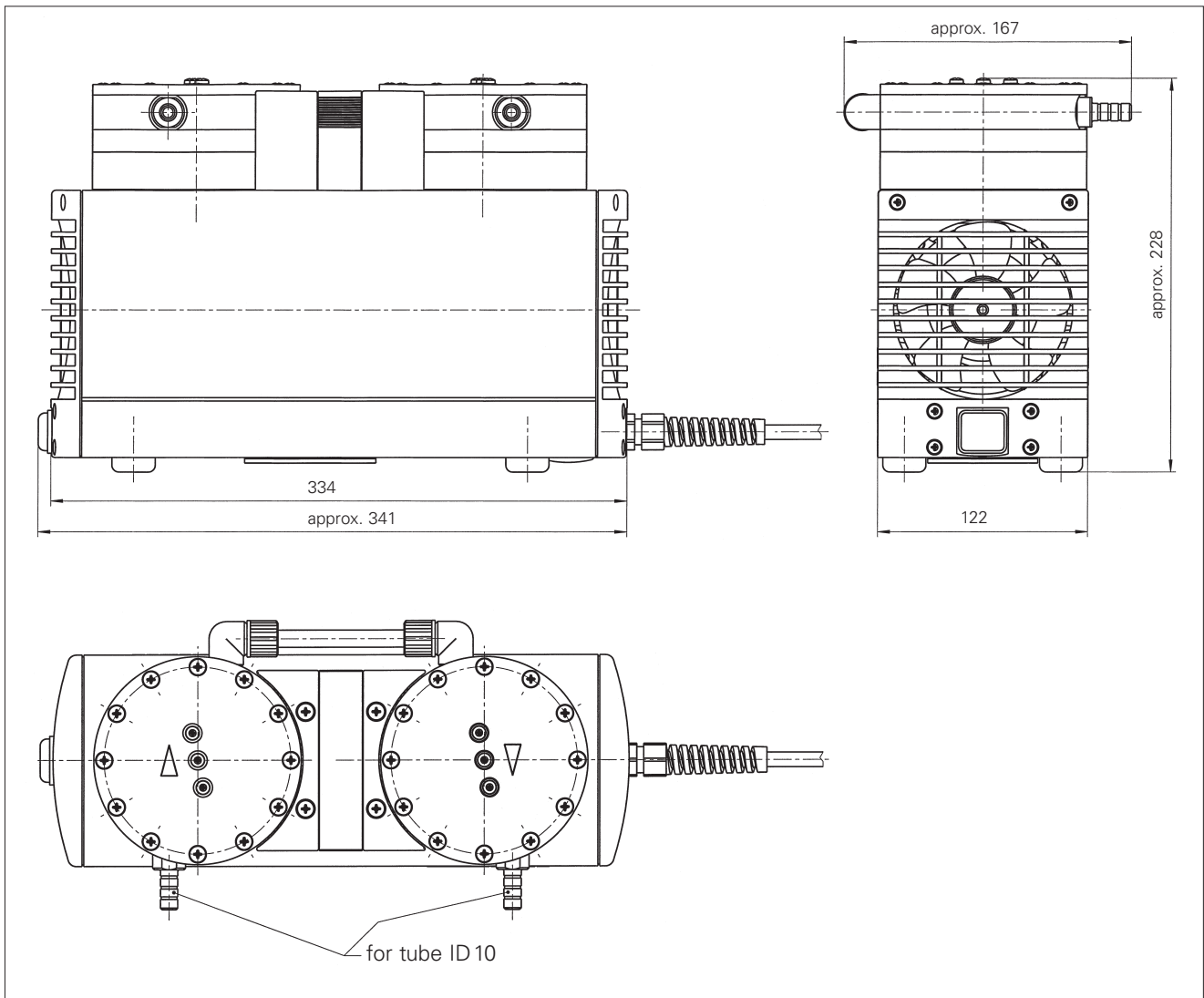



The KNF-Group worldwide

Germany

KNF Neuberger GmbH
Alter Weg 3
D-79112 Freiburg
Tel. +49 7664 5909 0
Fax +49 7664 5909 99
info@knf.de
www.knf.de

Benelux Netherlands

KNF Verder B.V.
Utrechtseweg 4a
NL-3451 GG Vleuten
Tel. +31 30 677 92 40
Fax +31 30 677 92 47
info@knf-verder.nl
www.knf-verder.nl

Benelux Belgium and Luxembourg

KNF Verder N.V.
Kontichsesteenweg 17
B-2630 Aartselaar
Tel. +32 3 871 96 24
Fax +32 3 871 96 28
info@knf.be
www.knf.be

China

KNF Neuberger Trading
(Shanghai) Co., Ltd.
No. 36 Lane 1000
Zhang Heng Road
Shanghai 201203
Tel. +86 21 6859 6566
Fax +86 21 6859 6568
info@knf.com.cn
www.knf.com.cn

France,

Marocco, Tunisia, Algeria

KNF Neuberger S.A.
4, Bld. d'Alsace Z.I.
F-68128 Village-Neuf
Tel. +33 389 70 35 00
Fax +33 389 69 92 52
info@knf.fr
www.knf.fr

United Kingdom

KNF Neuberger U.K., Ltd.
Avenue 2, Station Lane
Industrial Estate
Witney, Oxfordshire OX28 4FA
Tel. +44 1993 77 83 73
Fax +44 1993 77 51 48
info@knf.co.uk
www.knf.co.uk

India

KNF Pumps + Systems (India) Pvt. Ltd.
RAJIV GANDHI INFOTECH PARK,
Phase 1,
Ganga Estate, Survey No. 152/2/2,
Above AXIS BANK,
Hinjewadi, Pune 411 057
Tel. +91 20 640 13 923
+91 20 640 08 923
Fax +91 20 229 33 923
info@knfpumps.in
www.knfpumps.in

Italy

KNF ITALIA S.r.l.
Via Flumendosa, 10
I-20132 Milano
Tel. +39 02 272 03 860
Fax +39 02 272 03 848
info@knf.it
www.knf.it

Japan

KNF Japan Co.Ltd.
Across Shinkawa Bldg. Annex 3F,
1-16-14 Shinkawa, Chuo-ku,
Tokyo 104-0033
Tel. +81 3 3551 7931
Fax +81 3 3551 7932
info@knf.co.jp
www.knf.co.jp

Korea

KNF Neuberger Ltd.
Woosan Bldg.Rm#202
336-4, Hwikyung-Dong
Dongdaemun-Ku
130-090, Seoul
Tel. +82 2 959 0255
Fax +82 2 959 0254
knf@knfkorea.com
www.knfkorea.com

Sweden, Finland, Denmark, Norway

KNF Neuberger AB
Mejerivägen 4
P.O. Box 44060
SE-10073 Stockholm
Tel. +46 8 744 51 13
Fax +46 8 744 51 17
info@knf.se
www.knf.se

Switzerland Sales

KNF Neuberger AG
Stockenstrasse 6
CH-8362 Balternwil
Tel. +41 71 973 99 30
Fax +41 71 973 99 31
knf@knf.ch
www.knf.ch

Switzerland

Production Liquid Pumps
KNF FLODOS AG
Wassermatte 2
CH-6210 Sursee
Tel. +41 41 925 00 25
Fax +41 41 925 00 37
info@knf-flodos.ch
www.knf-flodos.ch

Switzerland

Production Micro Pumps
KNF Micro AG
Zelglimatte 1b
CH-6260 Reiden
Tel. +41 62 787 88 88
Fax +41 62 787 88 99
info@knf-micro.ch
www.knf-micro.ch

Taiwan

KNF Neuberger Ltd.
9F-2, No. 24, Lane 123, Section 6,
Min Chuan East Road
Neihu District
Taipei City, 11490
Tel. +886 2 2794 1011
Fax +886 2 8792 1648
knftwn@knftwn.com.tw
www.knftwn.com.tw

USA, Canada, South America

KNF Neuberger, INC.
Two Black Forest Road
Trenton, New Jersey 08691-1810
Tel. +1 609 890 8600
Fax +1 609 890 8323
knfusa@knf.com
www.knfusa.com
Latin America
Tel. +1 609 649 1010
gb@knf.com

Diaphragm Pumps + Systems



KNF Neuberger GmbH



KNF Neuberger, INC.



KNF Micro AG



KNF Neuberger S.A.



KNF FLODOS AG

The KNF-Production worldwide

Germany

KNF Neuberger GmbH
Freiburg-Munzingen

France

KNF Neuberger S.A.
Village-Neuf

Switzerland

KNF FLODOS AG
Sursee

Switzerland

KNF Micro AG
Reiden

USA

KNF Neuberger, INC.
Trenton - New Jersey