

HORIBA

Scientific



iHR Series

Spectrometers

ELEMENTAL ANALYSIS

FLUORESCENCE

GRATINGS &
OEM SPECTROMETERS

OPTICAL COMPONENTS

PARTICLE CHARACTERIZATION

RAMAN

SPECTROSCOPIC ELLIPSOMETRY

SPR IMAGING



iHR Series Imaging Spectrometers

A Unique Shape for a Unique Spectrometer

The difference between iHR spectrometers and other standard Czerny-Turner spectrometers can be seen at first glance. The iHR series is not just another square box in your lab. The final design, with the unique shape of the iHR series, was adopted to provide the best solution for essential parameters in imaging spectrometers: image quality, removal of re-diffracted light and maximized optical throughput.

Superior Imaging Performance

As an imaging spectrometer, the iHR has enhanced capabilities for use with a CCD. A toroidal mirror corrects for astigmatism, allowing the tangential (resolution optimized) and sagittal (imaging optimized) focal planes to cross at the center of the focal plane. This provides the flexibility to choose between imaging and resolution optimization (with a CCD detector) by selecting the desired detection angle. The iHR Series has one of the largest flat fields available in an imaging

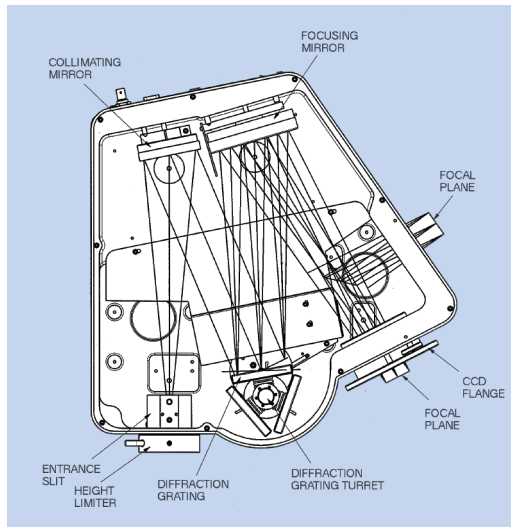

spectrograph. The imaging quality over the entire flat field has been maximized by using an asymmetric layout and a patented on-axis grating drive, reducing coma and other aberrations. A larger focus mirror allows the entire flat field to be used without vignetting (no throughput reduction at the edges of the focal plane).

No Re-diffracted Light

Re-diffracted light is light that enters the spectrometer and hits the grating twice due to an alignment of some rays of

diffracted light with one of the mirrors and the grating. This light diffracts off the grating a second time and shows as a dim background illumination on the output image. In spectroscopy, this light manifests as an elevated baseline and reduced sensitivity. This set of conditions happens across different wavelength regions and is more likely to occur in conventional symmetric Czerny-Turner spectrometers. Computer optimization of the asymmetric optical path eliminates re-diffracted light through precise placement of optical component locations.

The unique shape of the iHR series is a result of all these stringent design requirements.



All design factors were optimized to produce the most reliable optical platform and set new industry standards never achieved before in this class of imaging spectrometers.

Flexible & Easy to Use

The iHR provides a platform for spectroscopic measurements for years to come. The design of the spectrometer itself and its accompanying accessories and software enables users to customize the iHR for any experiment. This customization starts with the choice of entrance and exit ports, the library of HORIBA Scientific gratings, and the full line of spectroscopic accessories for various measurements.



SynerJY®, our general purpose spectroscopy software provides a platform for most measurements. Additional software possibilities are available, including our Software Development Kit and LabVIEW® VIs.

Manufacturing Excellence

The iHR series is built with the highest quality materials and structure. The instrument starts as a single casting and is machined until it acquires its unique shape. This eliminates possibilities of light leaks and provides the strongest possible housing for the instrument. The electronics are installed in a light compartment separate from the light tight optical cavity, under the spectrometer. After construction, the iHR goes through a series of rigorous burn-in and testing cycles. The drive mechanism is checked and rechecked to ensure that the system meets our repeatability and accuracy requirements.



iHR320 and iHR550 Specifications



iHR320		
Focal Length	320 mm	
Aperture	f/4.1	
Spectral Range	150 to 1500 nm w/1200 g/mm grating 150 nm to 40 μm w/appropriate gratings	
Grating Size	68 mm x 68 mm	
Number of Gratings on Turret	up to 3	
Flat Field Size	30 mm x 12 mm	
Resolution with Exit Slit and PMT	0.06 nm	
Wavelength Accuracy	±0.20 nm	
Repeatability	±0.075 nm	
Spectral Dispersion (@500 nm)	2.31 nm/mm	
Magnification	1.1	
Stray Light*	1.5 x 10 ⁻⁴	
Scan Speed	160 nm/sec	
Step Size	0.002 nm	
Computer Interface	Hi-Speed USB	
Dimensions	Length	417 mm (16.4 in)
	Width	422 mm (16.6 in)
	Height	192 mm (7.6 in)
	Optical Axis (Height from bottom of instrument)	98 mm (3.9 in)
	Nominal Weight	20 kg (45 lb)

iHR550		
Focal Length	550 mm	
Aperture	f/6.4	
Spectral Range	150 to 1500 nm w/1200 g/mm grating 150 nm to 40 μm w/appropriate gratings	
Grating Size	76 mm x 76 mm	
Number of Gratings on Turret	up to 3	
Flat Field Size	30 mm x 12 mm	
Resolution with Exit Slit and PMT	0.025 nm	
Wavelength Accuracy	±0.20 nm	
Repeatability	±0.075 nm	
Spectral Dispersion (@500 nm)	1.34 nm/mm	
Magnification	1.1	
Stray Light*	1 x 10 ⁻⁵	
Scan Speed	160 nm/sec	
Step Size	0.002 nm	
Computer Interface	Hi-Speed USB	
Dimensions	Length	648 mm (25.51 in)
	Width	460 mm (18.09 in)
	Height	193 mm (7.78 in)
	Optical Axis (Height from bottom of instrument)	98 mm (3.9 in)
	Nominal Weight	28 kg (62 lb)

*Stray measured at 1 nm from 514 nm laser with HORIBA Scientific Holographic Gratings.
All specifications given for 1200 g/mm grating at 435 nm and are subject to change without notice.

Seamless Integration with Synapse™ and Sincerity™ Scientific Cameras

A full line of scientific cameras is available for the iHR320 and iHR550 Spectrometers. The liquid nitrogen cooled Symphony II camera has set the industry standard for sensitivity, high speed, and low noise. The Symphony II is ideal for low light experiments where long integration times are required. The Symphony II can be equipped with Silicon, InGaAs or extended InGaAs sensors in order to cover a wide spectral range from 200 nm up to 2.2 microns.

The versatility of the TE cooled Synapse scientific camera makes it the ideal detector for most spectroscopy experiments. The Synapse is extensively used for Raman, Photoluminescence, Fluorescence and Emission applications. The Synapse is available with Silicon and InGaAs arrays.

The Sincerity CCD camera is our newest addition and has been designed for low budget experiments without compromising the specifications. The compact size of the Sincerity makes it the ideal candidate for OEM applications.



Expected Spectral Coverage & Resolution with a Synapse or Symphony CCD**

iHR320							
Grating (g/mm)	Dispersion (nm/mm)	Spectrometer Mechanical Range* (nm)	Spectral Coverage (nm) with 26.7 mm CCD	CCDs with 13.5 µm pixels		CCDs with 26 µm pixels	
				Single Pixel Spectral Coverage (nm)	Typical Spectral Resolution (nm)	Single Pixel Spectral Coverage (nm)	Typical Spectral Resolution (nm)
3600	0.47	0 to 500	12.5	0.006	0.02	0.012	0.04
2400	0.87	0 to 750	23	0.012	0.04	0.023	0.07
1800	1.38	0 to 1,000	37	0.019	0.06	0.036	0.11
1200	2.31	0 to 1,500	62	0.031	0.09	0.060	0.18
900	3.20	0 to 2,000	85	0.043	0.13	0.083	0.25
600	4.94	0 to 3,000	132	0.067	0.20	0.128	0.39
300	10.12	0 to 6,000	270	0.137	0.41	0.263	0.79
150	20.43	0 to 12,000	545	0.276	0.83	0.531	1.59

iHR550							
Grating (g/mm)	Dispersion (nm/mm)	Spectrometer Mechanical Range* (nm)	Spectral Coverage (nm) with 26.7 mm CCD	CCDs with 13.5 µm pixels		CCDs with 26 µm pixels	
				Single Pixel Spectral Coverage (nm)	Typical Spectral Resolution (nm)	Single Pixel Spectral Coverage (nm)	Typical Spectral Resolution (nm)
3600	0.29	0 to 500	7.7	0.004	0.01	0.008	0.02
2400	0.53	0 to 750	14	0.007	0.02	0.014	0.04
1800	0.81	0 to 1,000	22	0.011	0.03	0.021	0.06
1200	1.34	0 to 1,500	36	0.018	0.05	0.035	0.10
900	1.84	0 to 2,000	49	0.025	0.07	0.048	0.14
600	2.83	0 to 3,000	76	0.038	0.11	0.074	0.22
300	5.75	0 to 6,000	154	0.078	0.23	0.150	0.45
150	11.58	0 to 12,000	309	0.156	0.47	0.301	0.90

* The system's optical range will depend not only on the grating groove density, but also the grating blaze angle and the detector's spectral response.

** Dispersion, Spectral Coverage and Resolution values are given for 500 nm. These values may vary at different wavelengths.

Unmatched Flexibility in Applications

HORIBA Scientific's Optical Spectroscopy Division provides component-based systems configured to match your experimental requirements. Our spectrometers, detectors, and accessories can be configured in a variety of different ways to provide a flexible, high performance spectroscopy platform for your laboratory. Some common configurations that we routinely provide are described below.

Raman Spectroscopy

Raman spectroscopy is quickly becoming a popular method for investigating chemical structures and composition. HORIBA Scientific offers full flexibility in designing a component-based Raman detection set-up with choice of iHR spectrometers and Synapse™ or Symphony CCD and InGaAs detectors. Our systems are best suited for researchers wanting maximum flexibility in implementing their own collection optics, connecting to existing microscopes, or for budget limited researchers needing high sensitivity detection systems that can be expanded and upgraded in the future.

HORIBA Scientific's specialized Raman Division offers a full line of dedicated, and fully characterized Raman spectrometers.

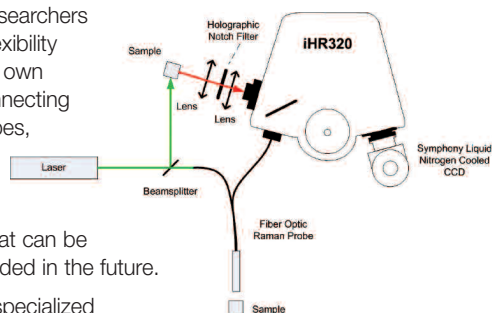

Photoluminescence (PL)

Photoluminescence is a simple yet powerful technique for characterizing semiconductor materials. An iHR550 equipped with a cooled CCD detector for the range of 400-1000 nm, and a cooled InGaAs detector for the 800-1600 nm range, is an excellent general purpose photoluminescence measurement system. Separate optical configurations can be designed for room temperature PL and low-temperature PL using the same iHR spectrometer. iHR spectrometers provide the flexibility to change experiments and optical configurations to meet your needs.

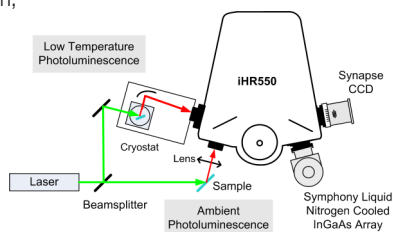

HORIBA Scientific's Sales and Applications staff can provide expert advice on configuring a system for your specific experiment.

Absorption / Transmission / Reflectance

Absorption, Transmission, and Reflectance spectroscopy techniques are commonly used for determining the properties of materials. The modularity of an HORIBA Scientific spectroscopy system outperforms a traditional UV-VIS spectrophotometer by allowing you to expand your experiment capabilities. The automated triple grating turret coupled with our motorized order sorting filter wheel, dual exit ports of the iHR320, and a wide variety of light sources and detectors give the flexibility needed to cover all wavelength ranges from 180 nm to 20 microns.

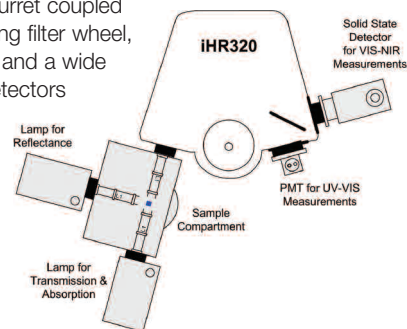

Fluorescence

With HORIBA Scientific spectroscopy components, you can design a custom fluorometer using iHR spectrometers as the excitation and emission spectrometers with a choice of excitation sources, sample compartments and detectors from our full line of products and accessories. Complete system control is available through our SynerJY® software.

HORIBA Scientific's specialized Fluorescence Division offers a full line of dedicated, fully characterized spectrofluorimeters and both time-domain and frequency-domain fluorescence lifetime instruments, featuring the world's most sensitive instruments for research and analytical environments.

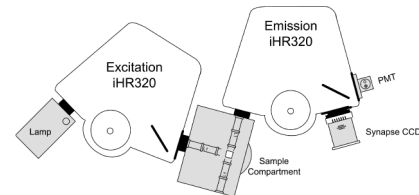

Plasma / Emission Analysis

Simultaneous recording of spectra at multiple locations in a plasma can provide critical information about spatially varying phenomena. A fiber with multiple inputs can collect light from different points in the plasma and arrange the signals into a line of points at the entrance slit of the spectrograph. Taking advantage of the imaging capability of an iHR spectrograph and Synapse CCD system, the spatially separated data is collected uniquely on the CCD and represents independent optical emission spectra from different fiber collection points.

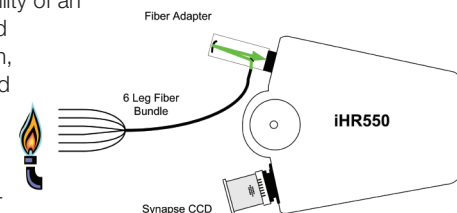

Ordering Information

The iHR320 and iHR550 are available in over 22 different configurations of entrance and exit slits and CCD/IGA array detectors. Contact your nearest sales representative for details.

Modular Raman System (available with iHR320/550).



TCSPC System (available with iHR320/550).



Photoluminescence System (available with iHR320/550).

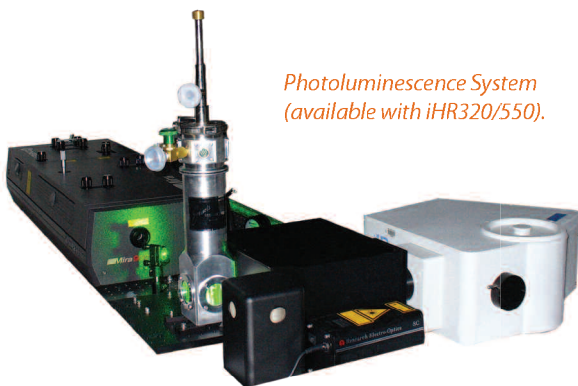

iHR Selected Accessories

AFW-IHR-UVIS	iHR320 Internal Filter Wheel, 6 x 25.4 mm (1 inch) filter positions
AFW-C6PM	External Filter Wheel, 6 x 25.4 mm (1 inch) filter positions
220-FSA	Filter Slide, 3 x 25.4 mm (1 inch) filter positions
AHC-C	Optical Chopper for use with IR detectors and Lock-In Amplifiers
AFO-XY	XY adjustable Fiber Optic Adapter for 10 mm and 1/4 inch ferrules
220F	Lens based fiber optic interface
ASC-VIS	SampleMax Sample Compartment
ASC-UV	SampleMax Sample Compartment optimized for UV
DPM-HV	UV-VIS Photomultiplier Tube (PMT) and Housing
DSS Detectors	Solid State Detectors including Si, Ge, InGaAs, InAs, PBs, PbSe & MCT
1427C	Solid State Detector Interface
CSW-SYNERJY	Data Acquisition Software

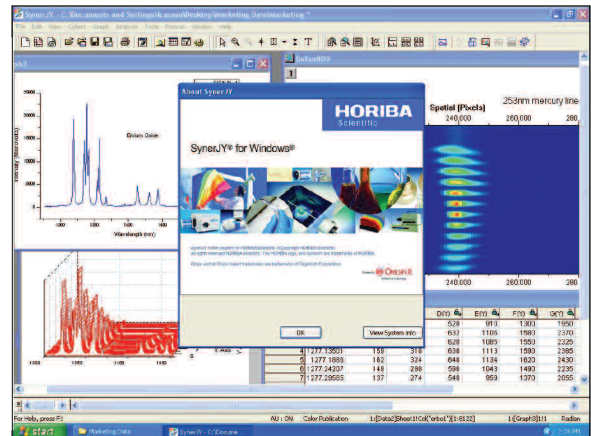

SynerJY™ software from HORIBA Scientific is a fully integrated data acquisition and data analysis software for spectroscopic systems. The software provides intuitive control of spectrometers, detectors (offering simultaneous detector control), and accessories. The user-friendly interface allows for quick access to powerful data processing and presentation tools. View data as 3-D plots, contour maps, or CCD images. Perform advanced mathematical functions, create custom views, and prepare and export data for reports in a variety of formats.



HORIBA
Scientific

info.sci@horiba.com

www.horiba.com/scientific

USA: +1 732 494 8660
UK: +44 (0)20 8204 8142
China: +86 (0)10 8567 9966

France: +33 (0)1 69 74 72 00
Italy: +39 2 5760 3050
Brazil: +55 (0)11 5545 1514

Germany: +49 (0) 89 4623 17-0
Japan: +81 (0)3 6206 4717
Other: +33 (0)1 64 54 13 00