

Piezoresponse Force Microscopy



NT-MDT: History and Background



- The oldest AFM manufacturer in the world
- Three-time R&D100 AWARD winner.
- The second position of global AFM manufacturers
- 250 experts in HQ offices

NT-MDT: Experience + Innovations



NT-MDT has achieved high results in **Piezoresponse Force Microscopy** technique development due to careful attention to the trends in the world of scientific research.

Piezoresponse Force Microscopy

The Basic Idea:

Step 1

Polarize the piezoelectric sample locally applying the electric potential

Step 2

Analyze the response

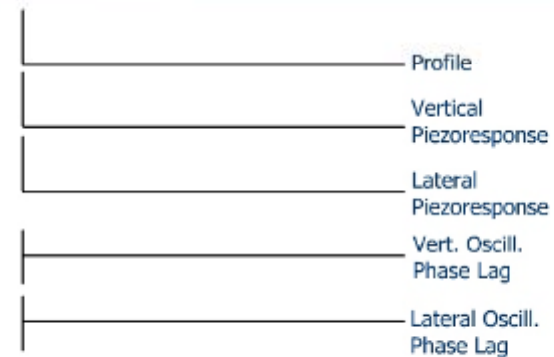
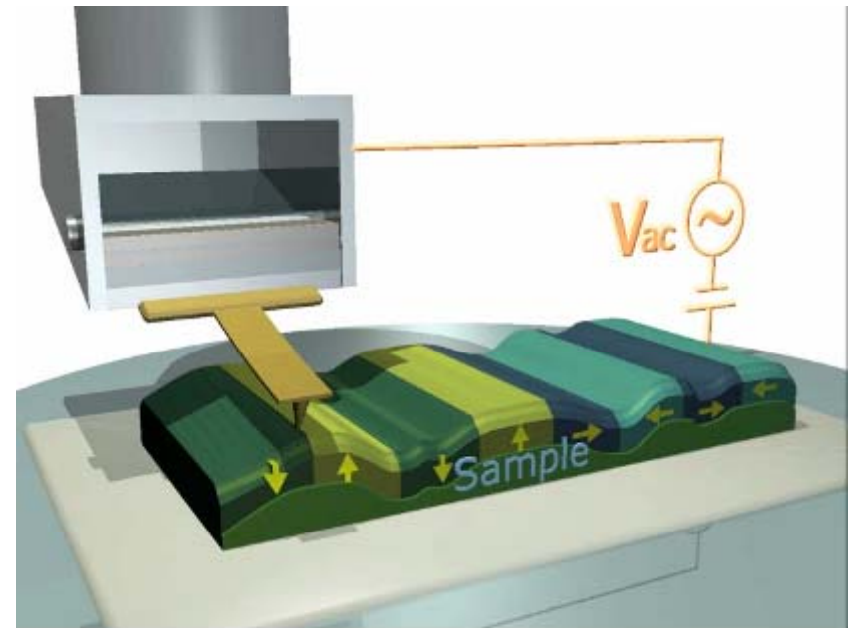

Copyright © NT-MDT, 2010

www.ntmdt.com

PFM is a Perspective Mode

PFM since its inception and first implementation has steadily attracted more and more interest.

It can be applied in various fields:

Ferroelectrics

Semiconductors

Biology

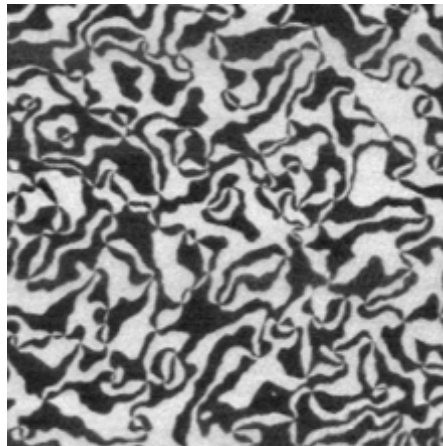

PFM image of a z-cut ferroelectric single crystal

Hexagonal domain structure of Lithium Niobate

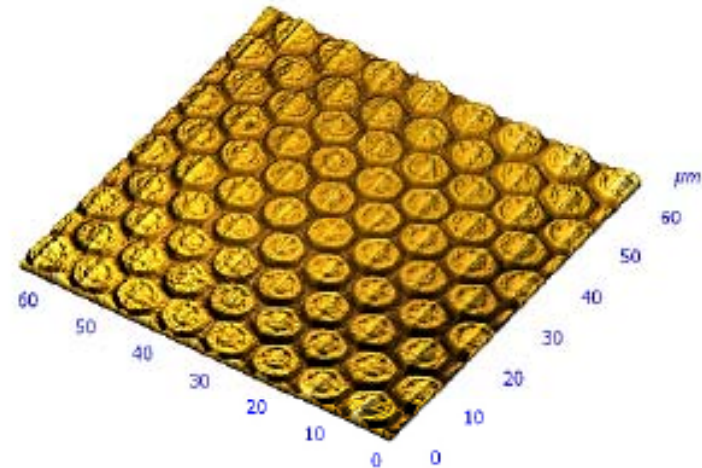

Sample courtesy by C. Gawith, Optoelectronics Research Centre University of Southampton.

Image courtesy of T. Jungk, A. Hoffmann, E. Soergel, University of Bonn.

Standard Mode of NT-MDT Equipment

PFM mode is implemented in each product of:

NTEGRA Platform



SOLVER Platform

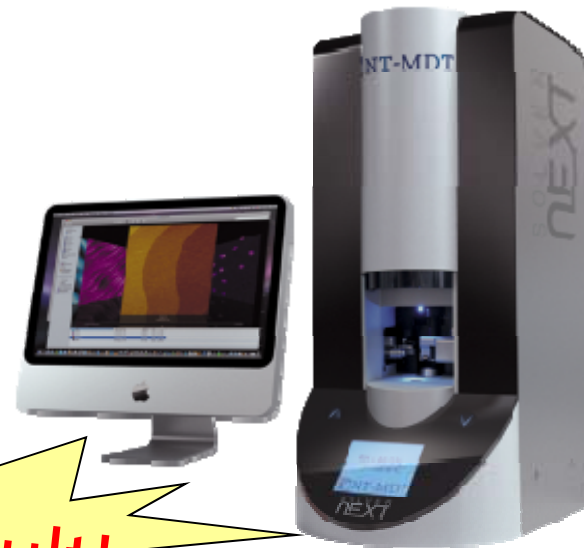

By Default!

NT-MDT meets the wishes of PFM researchers

Probes

DCP11

Tip with diamond-like
extra-stable coating

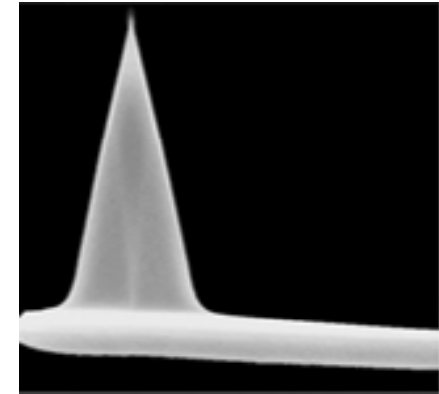
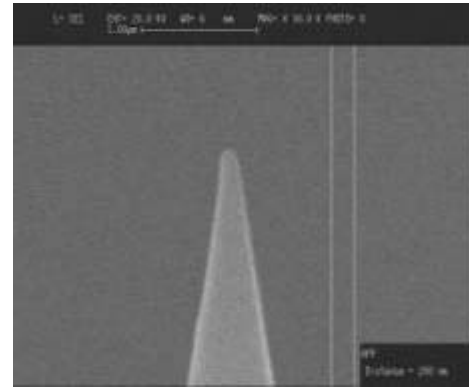

CSG01/Pt

High Resolution CONTACT
"GOLDEN" Silicon
Cantilevers CSG01 series
with PtIr conductive coating

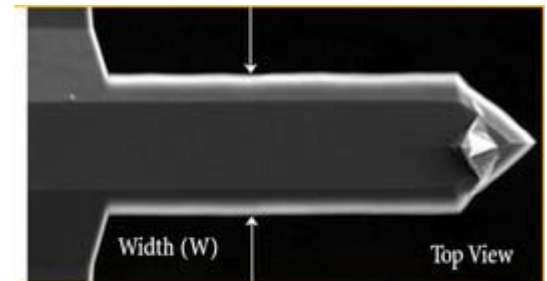
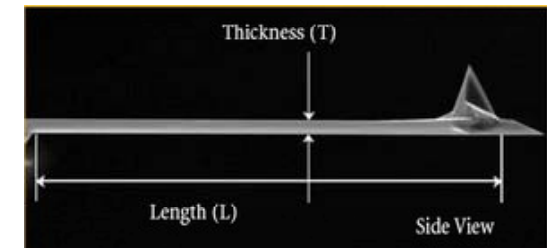

PFM Capabilities

Domain imaging

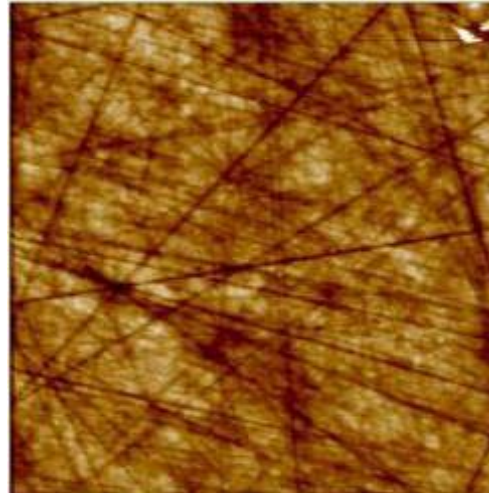

Topography image

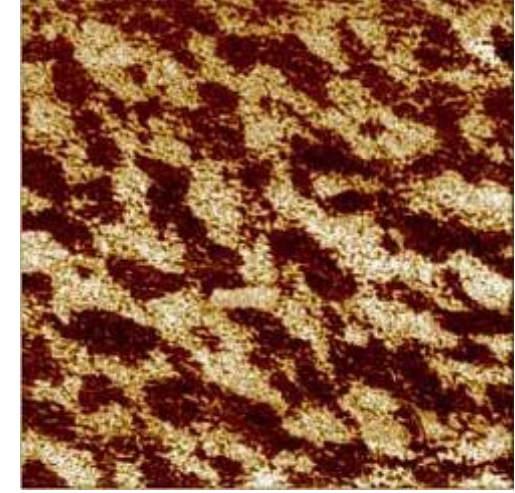

Piezoresponse image

Switching spectroscopy mapping

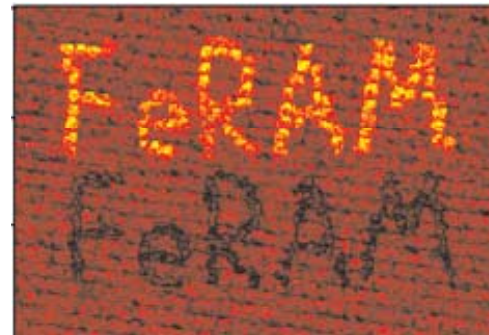

Domain lithography

Ferroelectric properties of the P(VDF-TrFE) nanostructures*

Source: Regular arrays of highly ordered ferroelectric polymer nanostructures for non-volatile low-voltage memories. Zhijun Hu^{1,2}, Mingwen Tian³, Bernard Nysten^{1,2} and Alain M. Jonas^{1,2}

PFM capabilities

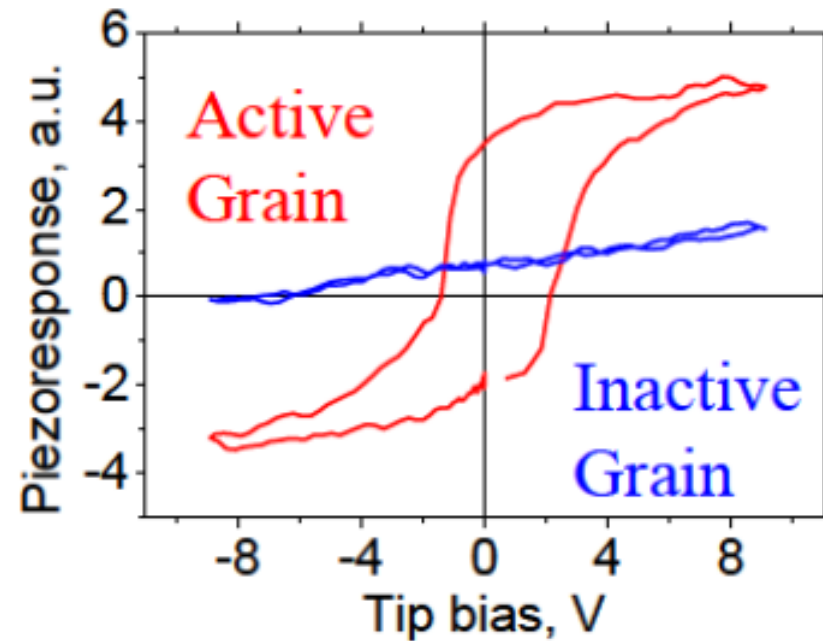
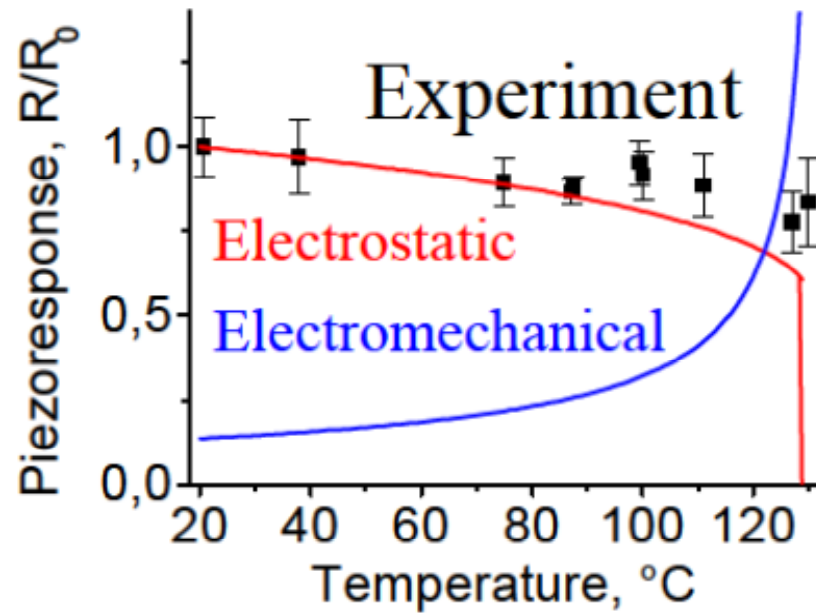

Temperature dynamics
and phase transitions

Spectroscopy

Thermal Control

Operation temperature range: from -20°C to $+300^{\circ}\text{C}$

Peltier

300°C heating stage

150°C heating stage

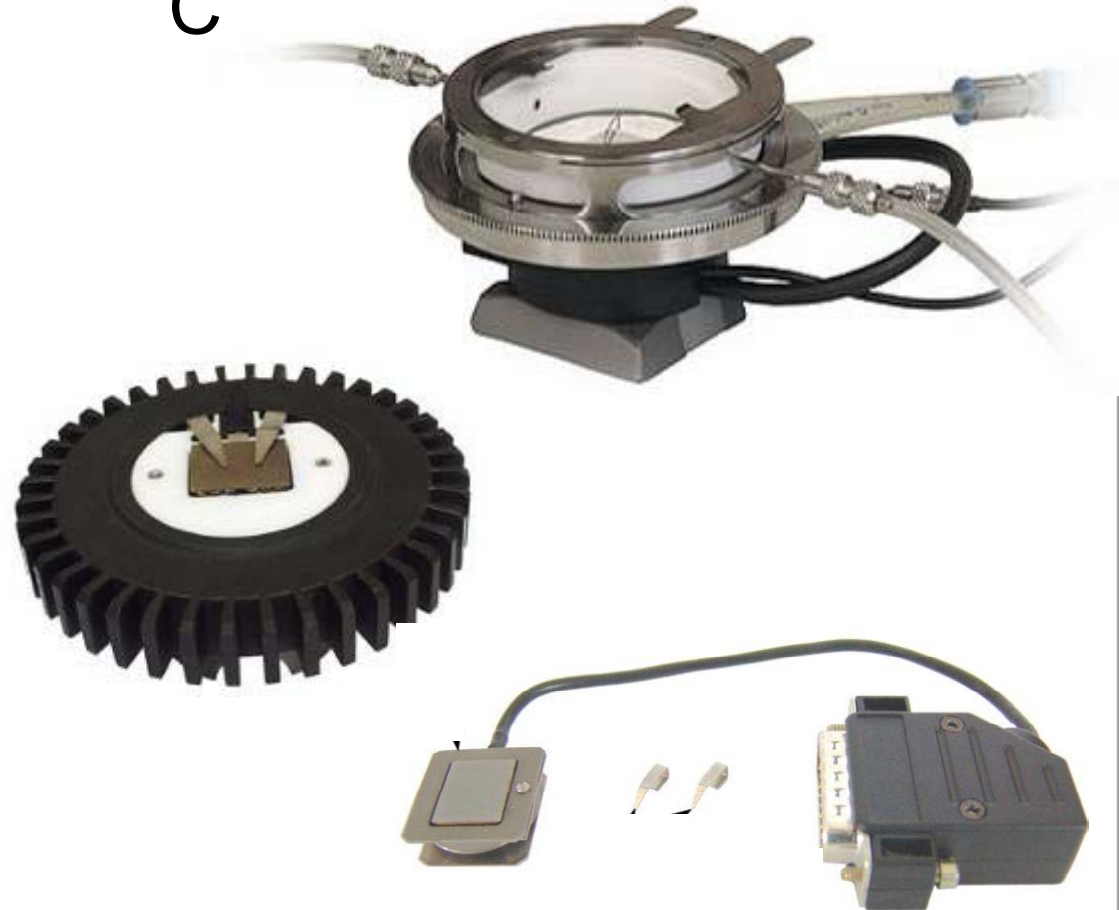

Piezo Hysteresis Spectroscopy

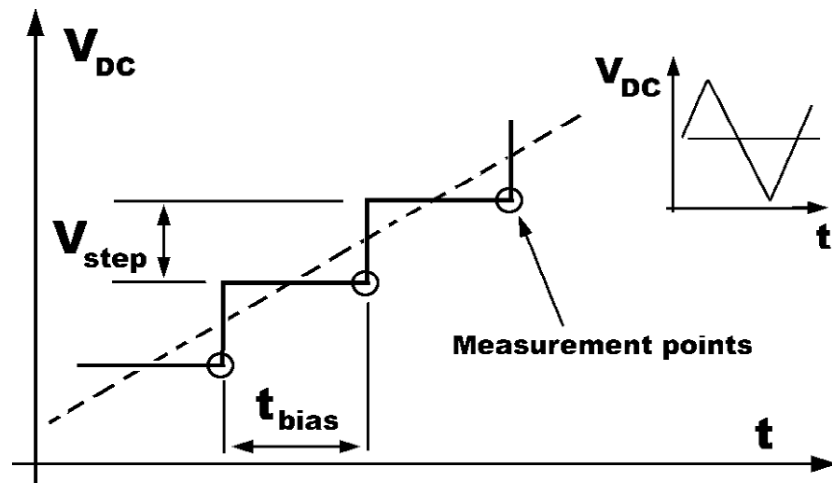

Measurements by steps

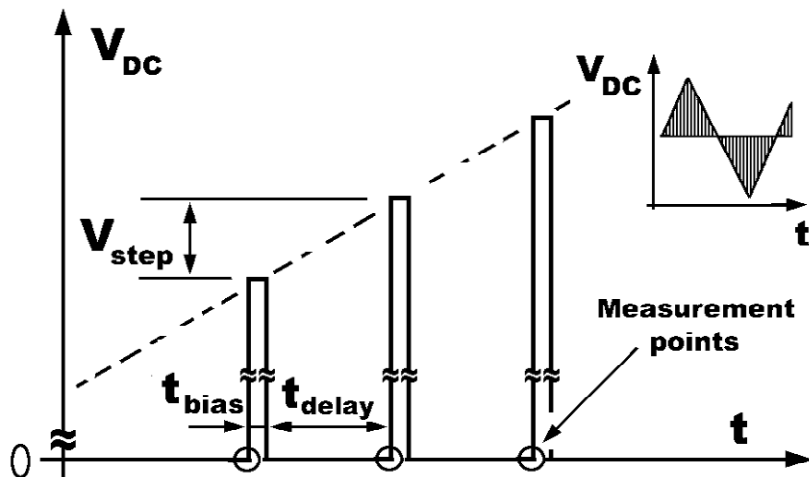

Measurements by peaks

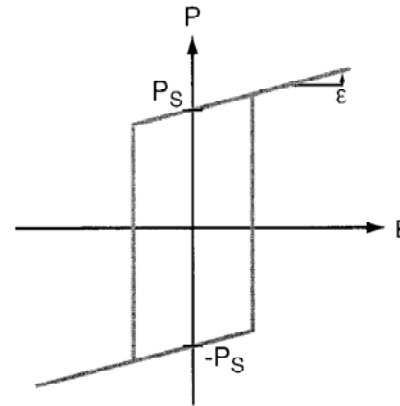

Hysteresis loop on a microscopic scale (within a single domain)

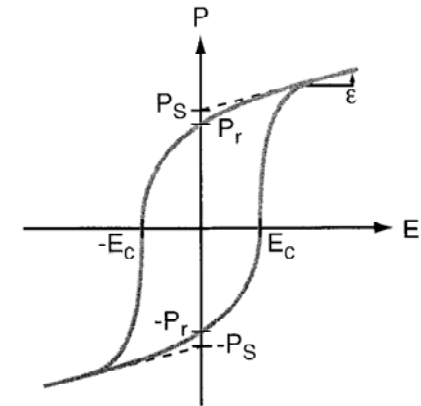

Hysteresis loop on a macroscopic scale

Note: the definitions of the spontaneous polarisation P_S , the remanent polarization P_r , and the coercive field E_c

Principle of Crosstalk Compensator

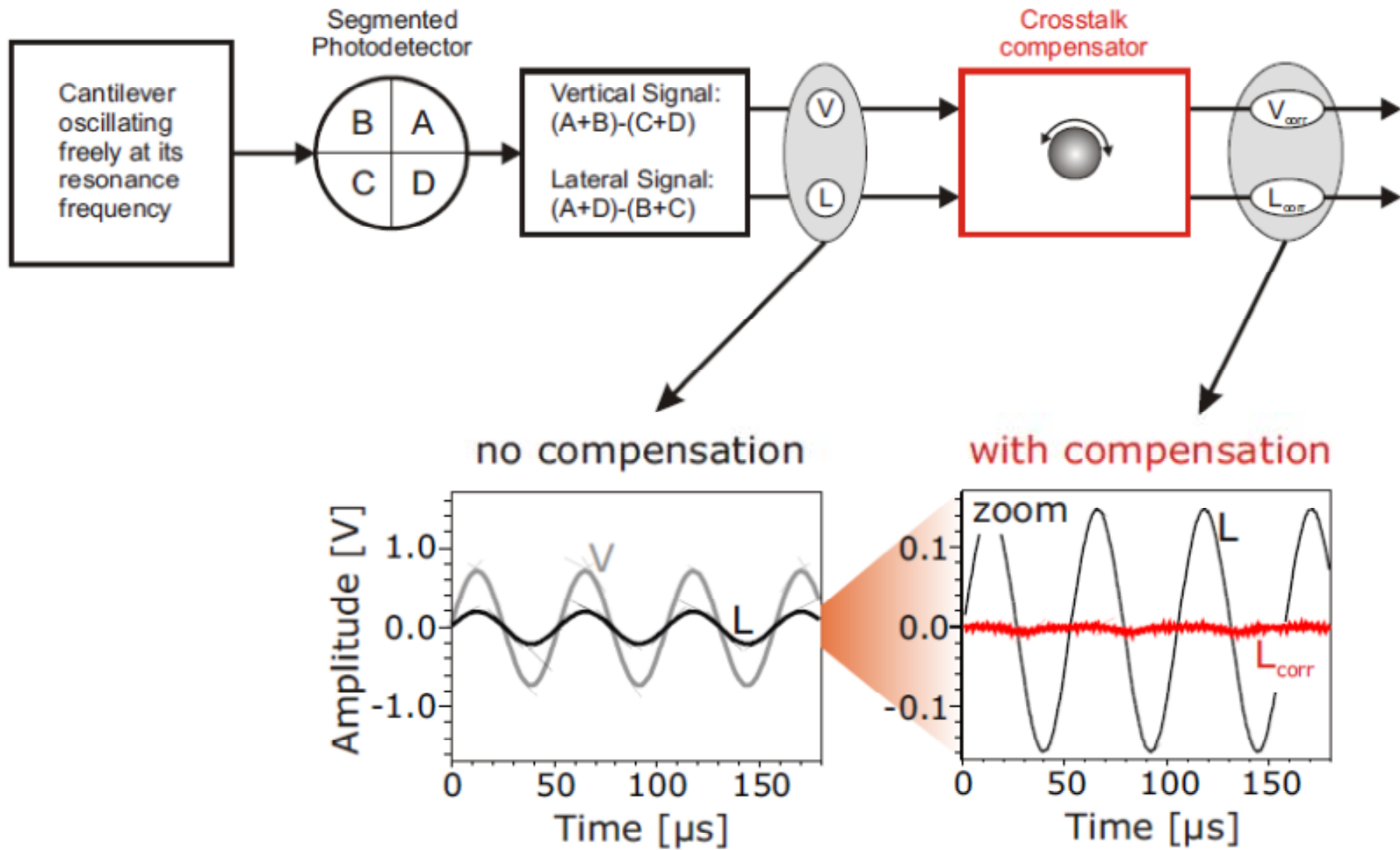

Basic Diagram for Crosstalk Compensator

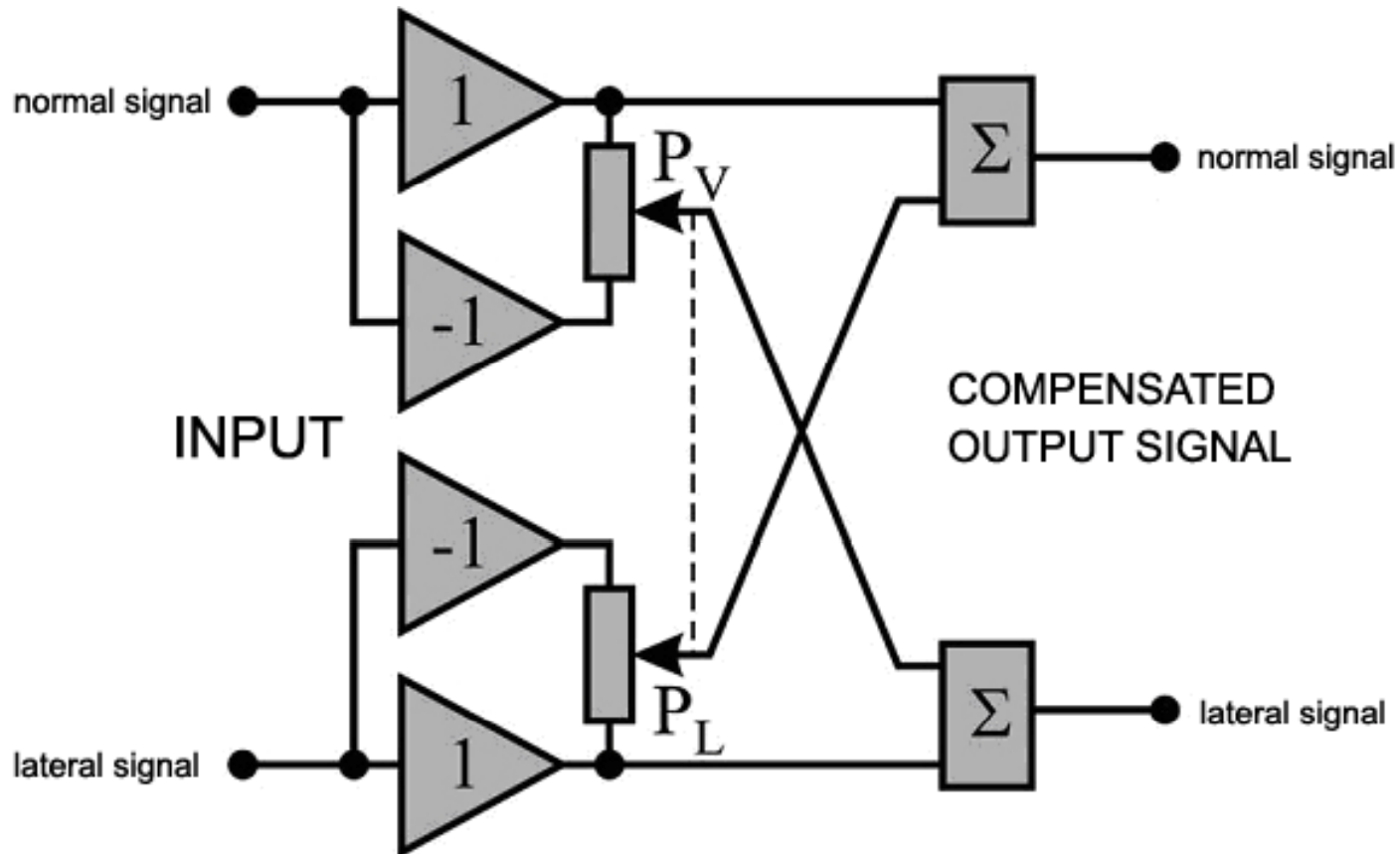

P_L, P_V - potential dividers, Σ - adder

Compensated signals:
$$\begin{bmatrix} V_c \\ L_c \end{bmatrix} = \begin{bmatrix} 1 & -x \\ x & 1 \end{bmatrix} \begin{bmatrix} V_m \\ L_m \end{bmatrix} = \frac{1}{\cos a} \begin{bmatrix} V \\ L \end{bmatrix}, \quad x = tga$$

Crosstalk Compensator Operation

Experiment with peptide nanotubes (high in-plane signal):

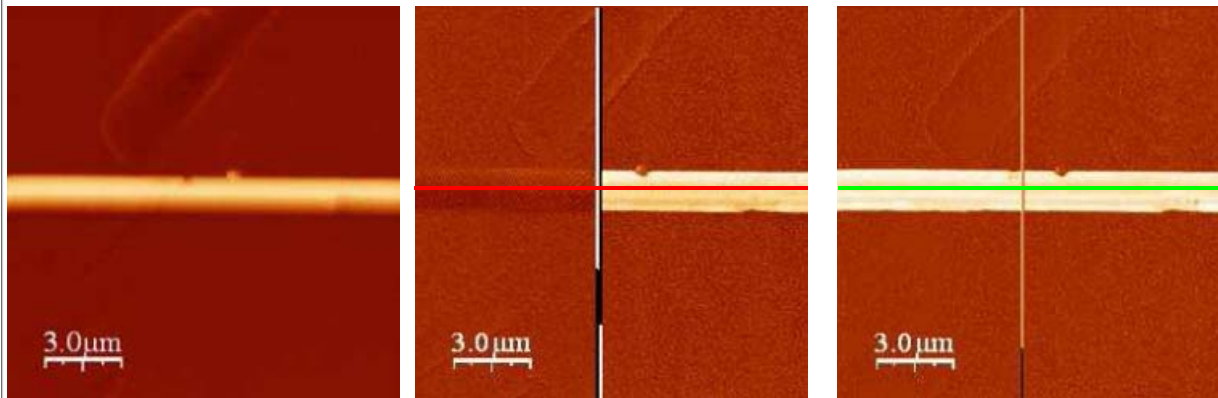

Left part of images:
with compensator

Right part of images:
without compensator

Topology

Amplitude
(vertical)

Amplitude
(lateral)

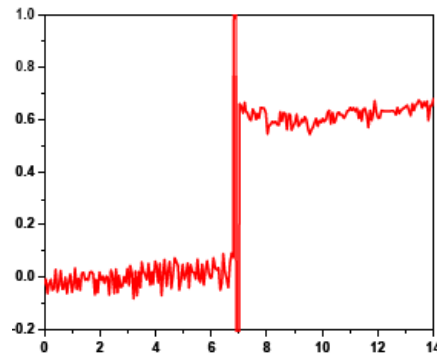

section

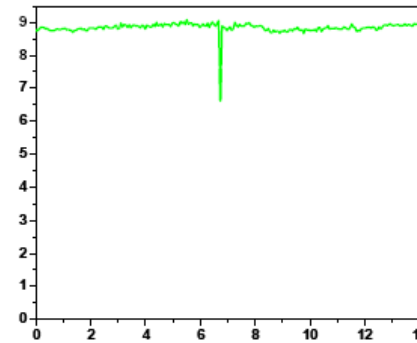

section

frequency 125 kHz,
amplitude 10 V

Crosstalk Compensator Operation

Experiment with TGS crystals (high out-of-plane signal):

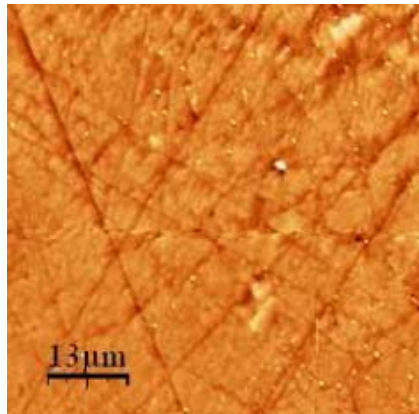

Topology

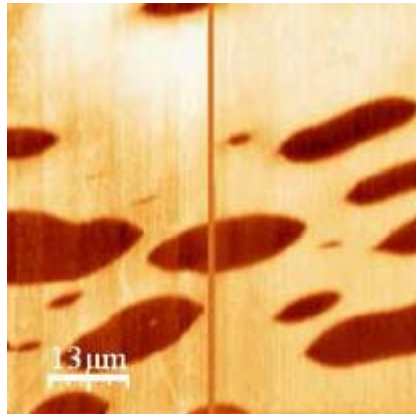

Amplitude
(vertical)

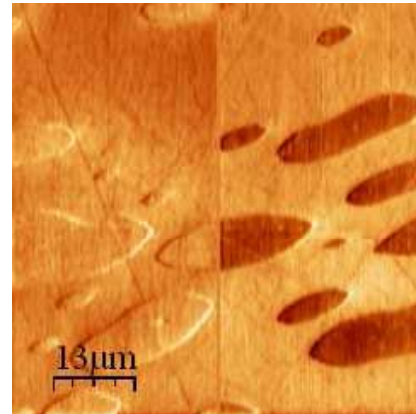

Amplitude
(lateral)

Left part of images:
with compensator

Right part of images:
without compensator

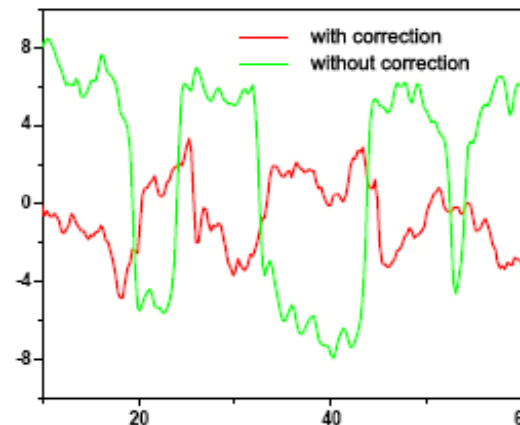
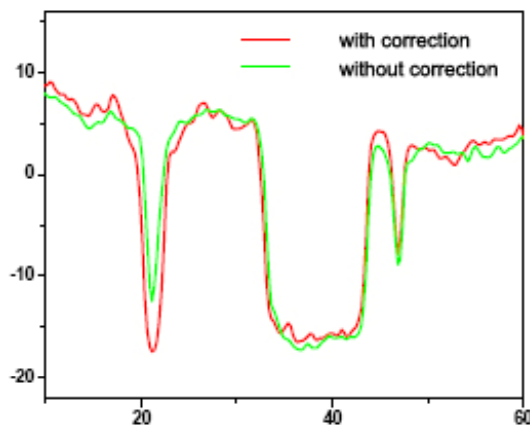

frequency 30 kHz,
amplitude 5 V
T=45 C° (after 60 C°)

Crosstalk Compensator

The Compensator eliminates the crosstalk effect



NT-MDT Crosstalk Compensator



Measurement Results

PFM : PZT High Resolution

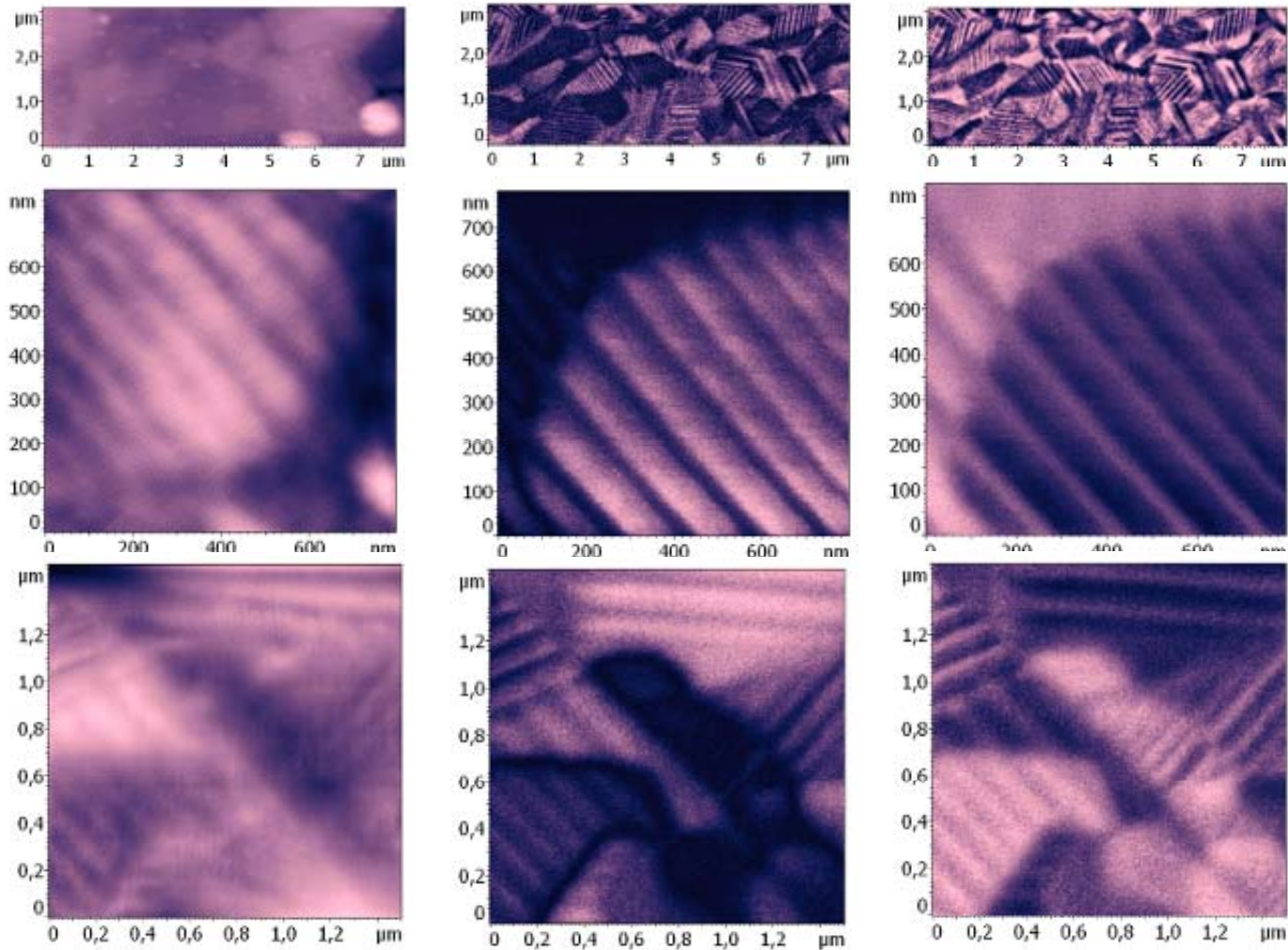

Topography

PFM Amplitude

PFM Phase

Thank You!