

Agilent 5500 or 5100 ILM AFM/SPM AFM Imaging on an Inverted Light Microscope

Data Sheet

Features and Benefits

- High-resolution atomic force microscope with inverted optical microscope allows simultaneous AFM and fluorescence imaging
- Top-down scanner design enables effortless setup
- Inverted optical view, open-top viewing access, and top illumination provide superior optical contrast
- Patented, rigid stage mounting provides low noise floor for sub-nanometer resolution
- Patented MAC Mode® option provides gentlest, nondestructive AFM imaging of samples in fluid
- PicoTREC™ option delivers real-time, simultaneous topography and recognition imaging
- Several sample-handling plates available to facilitate easy imaging in fluids or ambient air
- Easy Quick Slide sample-loading mechanism makes sample preparation simple
- Flow-through liquid cell lets researchers monitor real-time changes while exchanging solutions
- Temperature control available to enable imaging applications under a broader range of physiological conditions
- Full compatibility with Agilent's modular AFM/SPM microscopes offers simple upgrade path for extended capabilities



Overview

Agilent's 5500/5100 inverted light microscope (ILM) system combines the power of a high-resolution atomic force microscope (AFM) with the direct optical viewing capability of an inverted optical microscope. (Figure 1) The Agilent ILM offers unparalleled performance and ease of use for imaging in fluids. It extends AFM utility in order to encompass studies of single molecules, polymers, cell membranes, whole cells, and much more. Atomic force and optical (or fluorescence) microscopy data can be obtained simultaneously with the Agilent ILM (Figure 2).

The ILM's patented mounting design incorporates a rigid structure that provides the low noise floor needed to obtain sub-nanometer resolution. Furthermore, the advanced design allows the AFM to sit on top of an inverted microscope and under the illumination pillar, resulting in better optical contrast for the images (Figure 3).

Agilent's QuickSlide sample-loading mechanism and a flexible sample-handling plate make sample preparation easy. The microscope is positioned on the QuickSlide assembly, allowing the user to change samples and/or solutions without affecting the alignment of the AFM or the optical microscope (Figure 4).



Agilent Technologies

Imaging Options

Optimized for use with Agilent's 5500 or 5100 AFM/SPM, the ILM allows researchers to take advantage of the many powerful features that are available only with Agilent's AFM/SPM products. For instance, Agilent's patented MAC Mode, the most gentle imaging mode available for any AFM platform, provides unparalleled performance in fluids (Figures 6 and 7). Flow-through liquid cells and precise temperature control options allow users to image soft biological samples under controlled physiological conditions.

Agilent's proprietary sample plate stability further supports high-resolution AFM (Figure 5). Additionally, the unique Pico-TREC option delivers real-time, simultaneous topography and recognition imaging.

A wide range of complementary techniques can be performed with the ILM system including FRET, fluorescence, darkfield and brightfield microscopy.

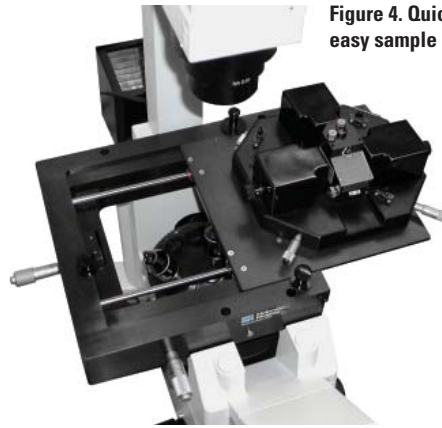
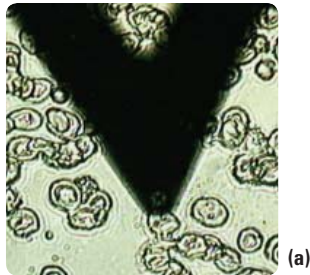

Figure 4. QuickSlide for easy sample loading.



Figure 5. Sample plates with (a) cover slide and liquid cell, and (b) Petri dish.



(a)

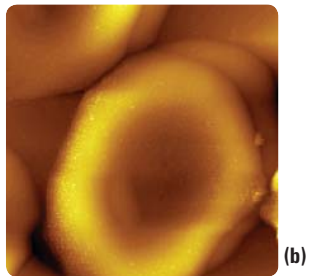

(b)

Figure 1. (a) Optical view of a red blood cell sample and AFM probe. (b) AFM topography image of a red blood cell. Scan size: 11 μm x 11 μm .

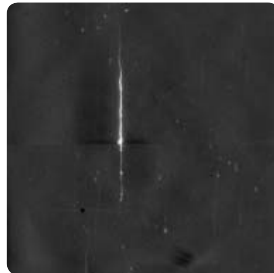

(a)

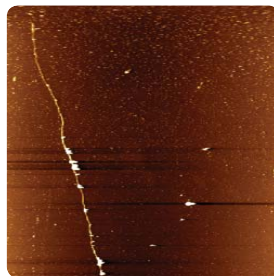

(b)

Figure 2. (a) Fluorescence microscope image of DNA and (b) corresponding in situ AFM scan at 30 nm x 45 nm.

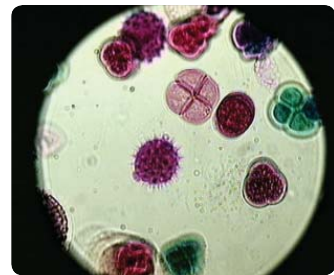

(a)

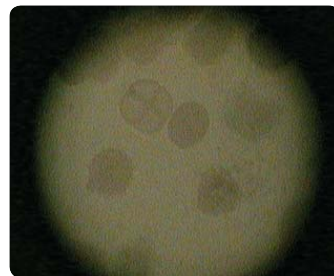

(b)

Figure 3. Agilent AFM top illumination (a) Top illumination compared to (b) bottom illumination

Multiple User Platform

The Agilent ILM is a modular, multiple-user platform. The open-architecture design permits easy access, manipulation, setup, and modification of samples while experiments are being performed. Convenient access to the sample plate and familiar sample preparation techniques make the ILM ideal for life science and other applications that require intensive sample preparation.

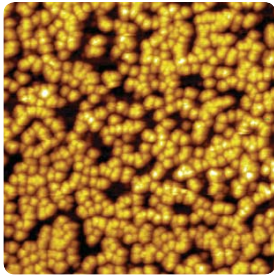

Figure 6. Ferritin molecules in water imaged with MAC Mode (raw data). Scan size: 1 μm x 1 μm .

Agilent's unique modular design also makes it easy to change imaging techniques (for example, MAC to EC or AFM to STM) or to use either the atomic force microscope or the optical microscope as a stand-alone system. Other operating modes available include current sensing AFM.

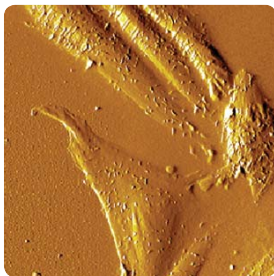

Figure 7. CHO cells in buffer imaged with MAC Mode. Scan size: 70 μm x 70 μm .

Industry-Standard Compatibility

The 5500 ILM is compatible with a wide selection of inverted optical microscopes and cameras. The researcher can use 25 mm Petri dishes and glass slides.

Applications

- Life science/biology
 - DNA
 - Proteins
 - Cell biology
- Polymer
- Thin films
- Nano beads
- Electrochemistry
- Non-aqueous solvents



(a) Escherichia Coli Bacteria

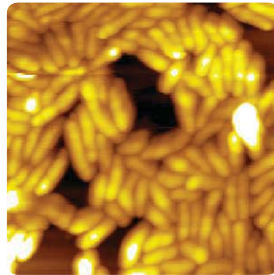

(b) Rhodospseudom Pallustris Bacteria

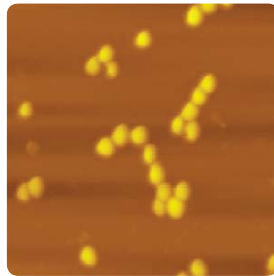

(c) Staphylococcus Aureus Bacteria

Figure 8. These images show how gelatin coated mica can be used to immobilize both gram negative and gram positive bacteria for imaging in liquid. Scan size 15 μm x 15 μm

AFM Instrumentation from Agilent Technologies

Agilent Technologies offers high-precision, modular AFM solutions for research, industry, and education. Exceptional worldwide support is provided by experienced application scientists and technical service personnel. Agilent's leading-edge R&D laboratories are dedicated to the timely introduction and optimization of innovative and easy-to-use AFM technologies.

www.agilent.com/find/afm

www.agilent.com

For more information on Agilent Technologies' products, applications or services, please contact your local Agilent office. The complete list is available at:

www.agilent.com/find/contactus

Phone or Fax

United States: (tel) 800 829 4444
(fax) 800 829 4433

Canada: (tel) 877 894 4414
(fax) 800 746 4866

China: (tel) 800 810 0189
(fax) 800 820 2816

Europe: (tel) 31 20 547 2111

Japan: (tel) (81) 426 56 7832
(fax) (81) 426 56 7840

Korea: (tel) (080) 769 0800
(fax) (080) 769 0900

Latin America: (tel) (305) 269 7500

Taiwan: (tel) 0800 047 866
(fax) 0800 286 331

Other Asia Pacific Countries:
tm_ap@agilent.com
(tel) (65) 6375 8100
(fax) (65) 6755 0042

Revised: 11/08/06

Product specifications and descriptions in this document subject to change without notice.

© Agilent Technologies, Inc. 2006
Printed in USA, December 21, 2006
5989-6005EN